







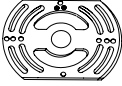

Fixture Name: Cerchi 1030-FM CH

This fixture assembled PO: _____ Date: _____

Notice: Please review the parts listing and check for all parts before assembling the fixture. If any parts are missing or damaged, please note on this sheet and contact the place of purchase to arrange for replacement parts.

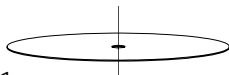
PARTS LIST

Company Name: _____ Co. Account #: _____
to be filled out by retailer

Circular mounting strap	1ea 	Wire connectors	3ea 	Green ground screw	1ea 
Mounting screw	2ea 	Hex nut	2ea 	Diffuser	1ea 
Junction Box Screw	2ea 	Deco nut	2ea 	Finial	1ea 

Part Needed	_____	Quantity	_____
Part Needed	_____	Quantity	_____
Reason why	(missing, scratched, broken glass, bent, bad finish)		
Comments	_____		

FIXTURE ASSEMBLY INSTRUCTIONS

Read and review installation instruction sheet before assembling the fixture.

ASSEMBLING THE FIXTURE (Fig.1)

- Slide Shade (H) through Fixture Connector (G) and secure Shade (H) to Frame (L) with Screws (K) .
Note: Complete these remaining steps after the fixture is hung.
- Install the light bulbs in accordance with the fixture's specifications.
- Slide Diffuser (I) to Shade (H) and secure in place by threading Bottom Finial (J) to the Fixture connector (G).

(DO NOT EXCEED MAXIMUM WATTAGE RATING)

NOTE: INSTALL THE DIFFUSER AFTER THE FIXTURE IS HUNG.

1030-FM CH

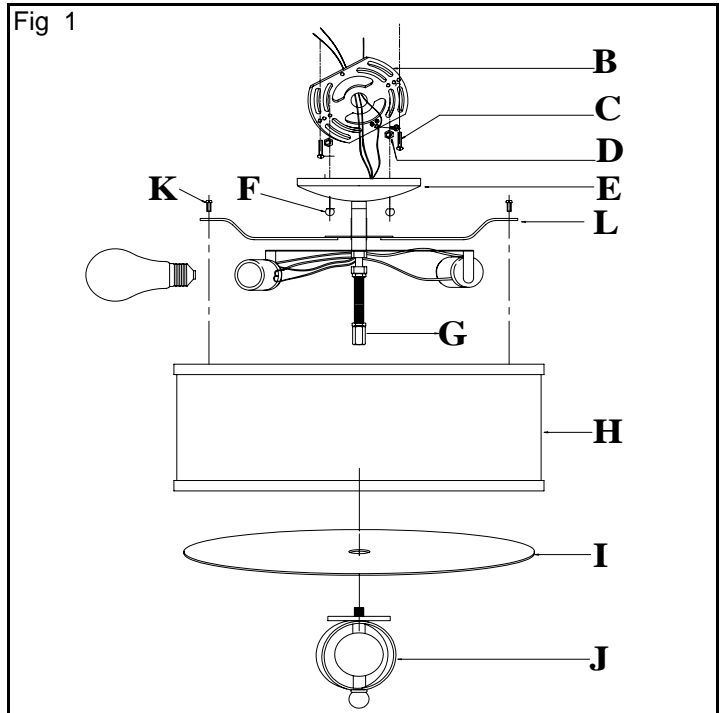

WARNING ! SHUT OFF POWER AT FUSE OR CIRCUIT BREAKER.

HANGING THE FIXTURE (Fig.1)

1. Carefully remove the new fixture from the carton and the yellow bag that holds all your parts. Check that all parts are included as shown in the illustration and parts list.
2. Shut off power at the circuit breaker and remove the old fixture from ceiling, including the old mounting strap.
3. Thread the two fixture Mounting screws (A) into the pre-drilled Holes in the Mounting strap (B) spaced the same distance apart as the holes in the fixture top cap. Secure in place with Hex nuts.
4. Attach Mounting Strap (B) to the junction box using the two Mounting Screws (C)

CONNECTING THE WIRES (Fig 2)

5. Attach the power supply wires to the fixture lead wires by connecting BLACK to BLACK (or SMOOTH) and WHITE to WHITE (or RIBBED).
6. Attach the GROUND wire (GREEN or COPPER) from the Junction Box and the fixture Ground wire to the green Ground Screw on the Mounting Bracket (B) or connect both wires together using the correct size of wire connectors.

NOTE: Twist the wires together in the same direction you twist the wire connector onto the wires.

7. Tuck these wire connections neatly into the Junction Box.

FINISHING THE INSTALLATION (Fig.3)

8. Raise Fixture top cap (E) to the ceiling with the fixture Mounting screws (A - Fig. 1) protruding through holes and secure in place with Deco nuts (F).
9. Install the light bulbs and diffuser as per the fixture assembly sheet.

YOUR INSTALLATION IS NOW COMPLETE. RETURN POWER TO THE JUNCTION BOX AND TEST THE FIXTURE.

