







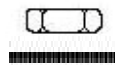

PARTS & ASSEMBLY SHEET

Fixture Name: Echelon 8981-WSC BRI / GRM

This fixture assembled PO: _____ Date _____

Notice: Please review the parts listing and check for all parts before assembling the fixture. If any parts are missing or damaged, please note on this sheet and contact the place of purchase to arrange for replacement parts.

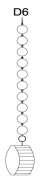
PARTS LIST		Company Name: _____ Co. Account #: _____	
below to be filled out by retailer			
Mounting Strap  1ea 100*22*H4mm	Deco nut  2ea 5/32-IP*H9mm	Mounting Screw  2ea 8/32*H1"	
Hex nut & nipple  1ea 1/8-IP*H3cm 2ea 5/32-IP*H3mm	Wire connectors  2ea Orange 2ea P3 Orange	Green screw  1ea 8/32*H10mm	
Crystal drops B2 x 6pcs 	Crystal drops B3 x 2pcs 	Crystal drops C2 x 2pcs 	Crystal drop D6 x 1pcs 
Crystal drops are included in parts bag. (see crystal assembly instruction)			
Part Needed	_____		Quantity _____
Part Needed	_____		Quantity _____
Reason why	(missing, scratched, broken glass, bent, bad finish)		
Comments	_____		

FIXTURE ASSEMBLY INSTRUCTIONS

Read and review installation instruction sheet before assembling the fixture.

1. Install the lighting bulbs in accordance with the fixture's specification.
2. Attach the Crystal strands to the loops on fixture.

(DO NOT EXCEED MAXIMUM WATTAGE RATING!)

NOTE: THE SHADE ASSEMBLY IS SHIPPED INSTALLED ON THE FIXTURE.

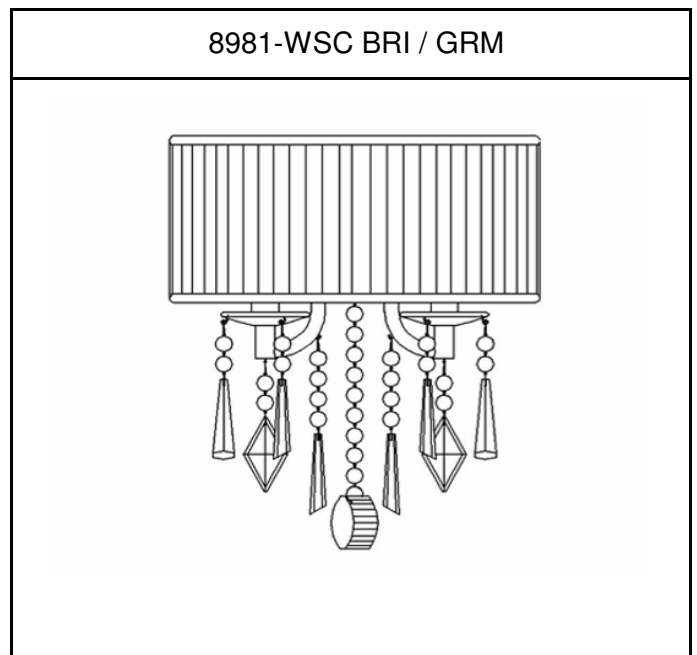

WARNING ! SHUT OFF POWER AT FUSE OR CIRCUIT BREAKER.

HANGING THE FIXTURE (Fig.1)

1. Carefully remove the new fixture from the carton and the yellow bag that holds all parts. Check that all parts are included as shown in the illustration and parts list.
2. Shut off power at the circuit breaker and remove old fixture from wall including the old mounting strap.
3. Thread Nipple (H) into Mounting Strap (D) as shown on Fig.1.
4. Place Lock Washer (E) over end of Nipple (H) protruding through Mounting strap (D) and thread Hex Nut (F) onto Nipple (H) until tight as shown on Fig.1.
5. Attach Mounting Strap (D) assembly to the ceiling junction box (A) (not provided) using the two Mounting Screws (G). Tighten screws (G) securely with screw driver.

Fig. 1

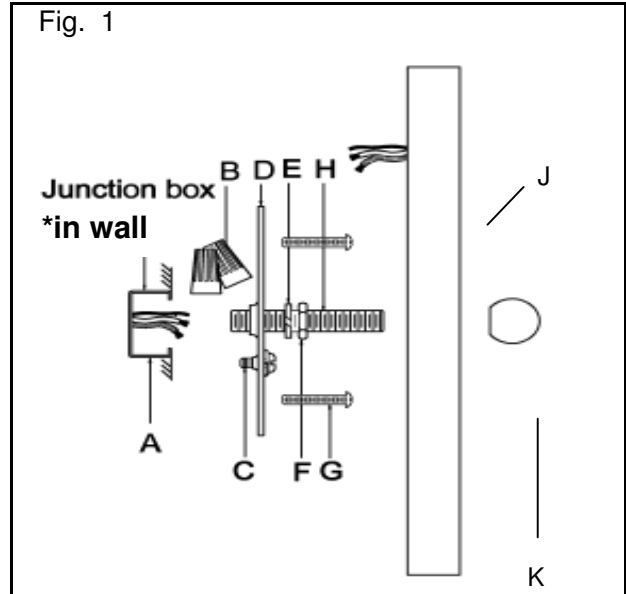

CONNECTING THE WIRES (Fig 2)

6. Attach the power supply wires to the fixture lead wires by connecting BLACK to BLACK (or SMOOTH) and WHITE to WHITE (or RIBBED).
 7. Attach the GROUND wire (GREEN or COPPER) from the Junction Box and the fixture Ground wire to the green Ground Screw on the Mounting Bracket (D) or connect both wires together using the correct size of wire connectors.
- NOTE: Twist the wires together in the same direction you twist the wire connector onto the wires.
8. Tuck these wire connections neatly into the Junction Box.

Fig. 2

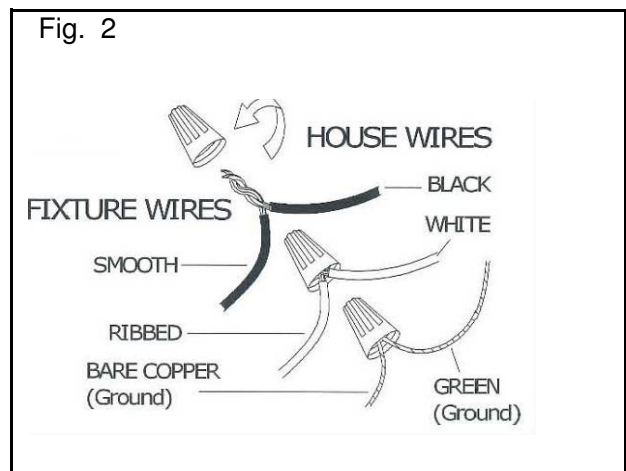

FINISHING THE INSTALLATION (Fig.3)

9. Place the fixture Back Plate (J) over the nipple (H) and secure the Back Plate (J) against the wall by threading cap nut (K) until tight as shown on Fig.1
10. Install the Fabric shade and light bulbs as per the fixture assembly sheet.

Fig. 3

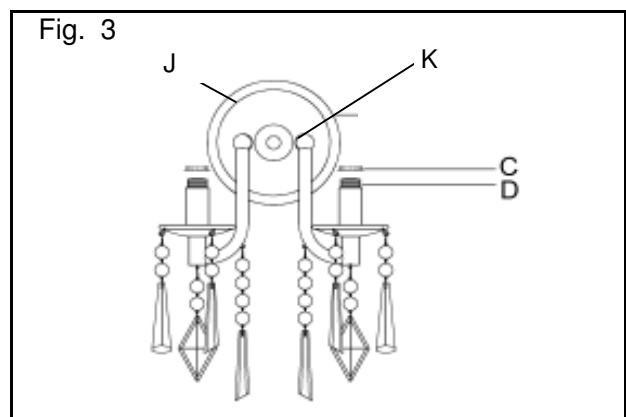

YOUR INSTALLATION IS NOW COMPLETE. RETURN POWER TO THE JUNCTION BOX AND TEST THE FIXTURE.

CRYSTAL INSTRUCTION

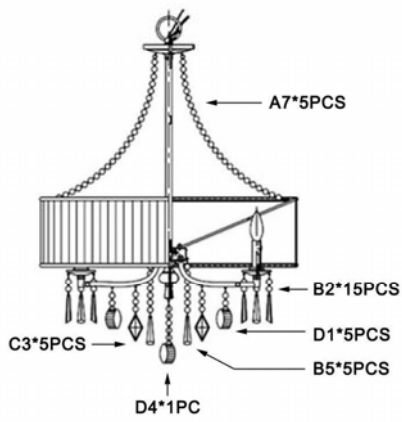

8981/5

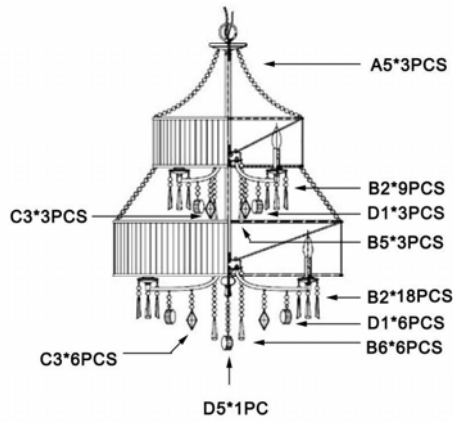

8981/9

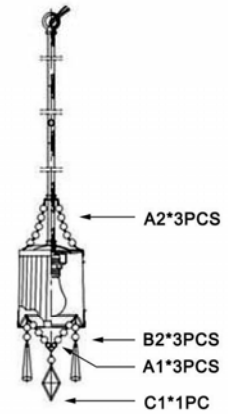

8981/M1L

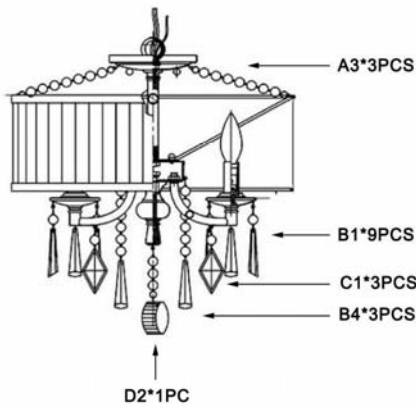

8981/SF

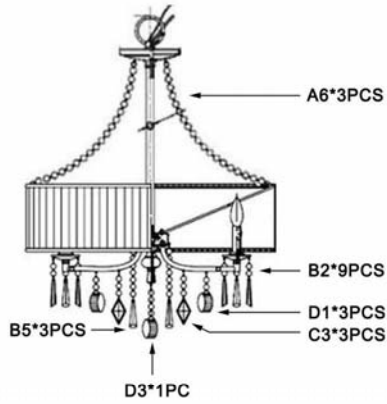

8981/3P

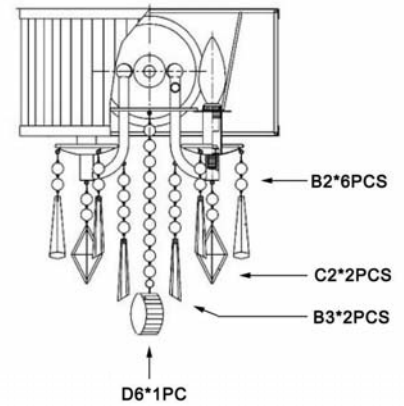

8981/WSC

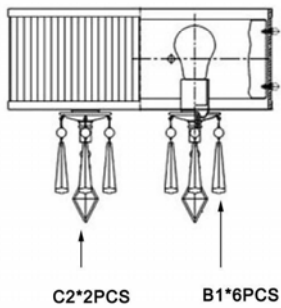

8981/BA2

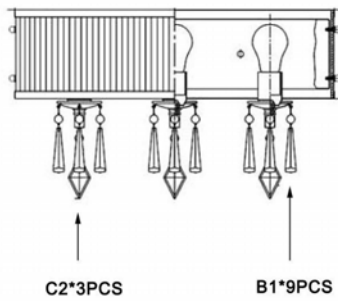

8981/BA3

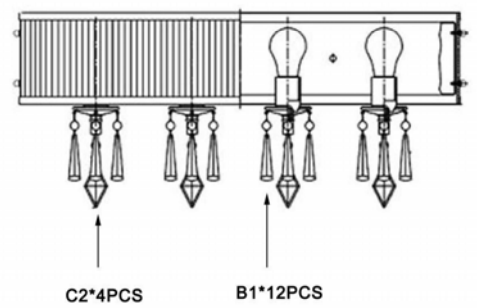

8981/BA4

