



GOLDEN
Elegant lighting for everyday living

PARTS & ASSEMBLY SHEET











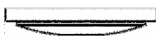

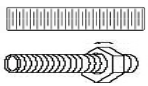

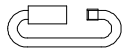

Fixture Name: Echelon 8981-9 BRI / GRM

This fixture assembled PO: _____ Date: _____

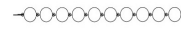
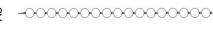
Notice: Please review the parts listing and check for all parts before assembling the fixture. If any parts are missing or damaged, please note on this sheet and contact the place of purchase to arrange for replacement parts.

PARTS LIST

Company Name: _____ Co. Account #: _____
to be filled out by retailer

| | | | | | |
|--|--|---|---|--|--|
| Canopy 1ea 130*H22mm  | Hex nut 1ea 1/2"*H3mm  | Nipple 2ea 1/2"*H55mm  | | | |
| Chain 1ea 3.8mm*L72"  | Wire Connector 2ea A3 Orange  | Bottom cap 1ea 50*H56mm  | | | |
| Chain connector 2ea 5*H58.5mm  | Mounting Screw 2ea 8/32"*H1"  | Finial 1ea 22*H40mm  | | | |
| Mounting Strap w/ ground screw 1ea 100*22*H4mm /1ea 8/32"*H10mm  | Canopy Loop and Canopy loop collar 1ea 1/2"*H46mm  | Crystal draping A4 x 6pcs A4  | Crystal draping A5 x 3pcs A5  | | |
| Crystal drops B2 x 27pc: B2  | Crystal drops B5 x 3pcs B5  | Crystal drops B6 x 6pcs B6  | Crystal drops C3 x 9pcs C3  | Crystal drops D1 x 9pcs D1  | Crystal drops D5 x 1pcs D5  |

Crystal drops are included in parts bag. (see crystal assembly instruction)

| | |
|---|----------------|
| Part Needed _____ | Quantity _____ |
| Part Needed _____ | Quantity _____ |
| Reason why (missing, scratched, broken glass, bent, bad finish) | |
| Comments _____ | |

FIXTURE ASSEMBLY INSTRUCTIONS

Read and review installation instruction sheet before assembling the fixture.

1. Feed the fixture wires through the long Threaded rod (F) and pull the wires until taut.
2. Slide the tube (E), tube lid (D), cup (C), long Threaded rod (F), Top cap (B), Top loop (A) down to housing of fixture.
3. Screw Threaded rod (F) all the way into the coupler (L) at housing of fixture. Screw Top loop (A) into Top cap (B).

NOTE: THE SHADE ASSEMBLY CAN BE DAMAGED BY ROUGH HANDLING. USE CARE WHEN ASSEMBLING.

8981-9 BRI / GRM

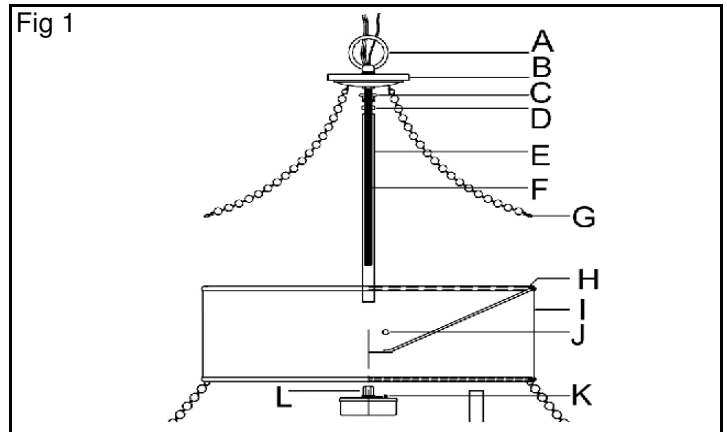

For Customer Service, contact the place of purchase to arrange for replacement parts.

PARTS & ASSEMBLY SHEET

Fixture Name: Echelon 8981-9 BRI / GRM

* NOTE: The Finial can be scratched or broken if the full weight of the fixture is placed on it. To avoid damage attach these Bottom Assembly parts after hanging the fixture.

4. Slide the center support of the Fabric shade (V) over center tube to the housing, it is open on one side for ease of assembly. Secure in place by tightening Cap nut (O) to Screw on Frame (P) with frame of shade between them (V).
- Repeat with Fabric shade (I), Nuts (J) and Frame screws (K).

5. Attach 3 crystal draping chain (G) to hook (H) of shade(I).Then attach 3 crystal draping chain (M) to hook (N) of shade(V)

6. By measuring determine correct number of links needed for proper hanging height. Use a pair of pliers to open one link of the Chain (A2) then remove the excess Chain (A2) and discard it.

7. Use one chain connector(A12) to attach one end of the chain to the Top loop (A) and close the chain connector.

8. Feed the fixture wires through the Chain (every three links) and pull the wires until taut.

9. Slip Canopy loop collar (A11) over the chain, then do the same with the canopy .

10. When ready to complete the installation Use the other chain connector and attach the other end of the chain to the canopy loop (A10) and close the chain connector.

11. Make sure the weight of the chandelier is supported by the chain-not the electrical wire.

* You may now install the fixture.

Note: Complete these remaining steps after the fixture is hung.

12. Secure threaded nipple (S) to bushing (Q) of housing and screw Hex nut (R) on to secure.

13. Place Bottom cap (T) over the Threaded nipple (S).

14. Screw Finial (U) to threaded nipple (S).

15. Install the light bulbs in accordance with the fixture's specifications.

(DO NOT EXCEED MAXIMUM WATTAGE RATING)

Fig 2

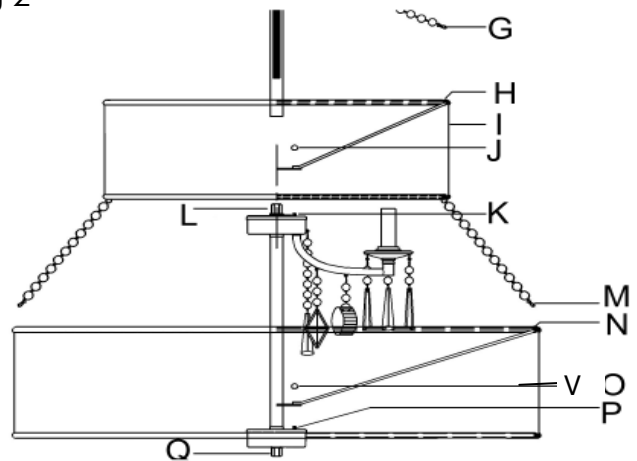

Fig 3

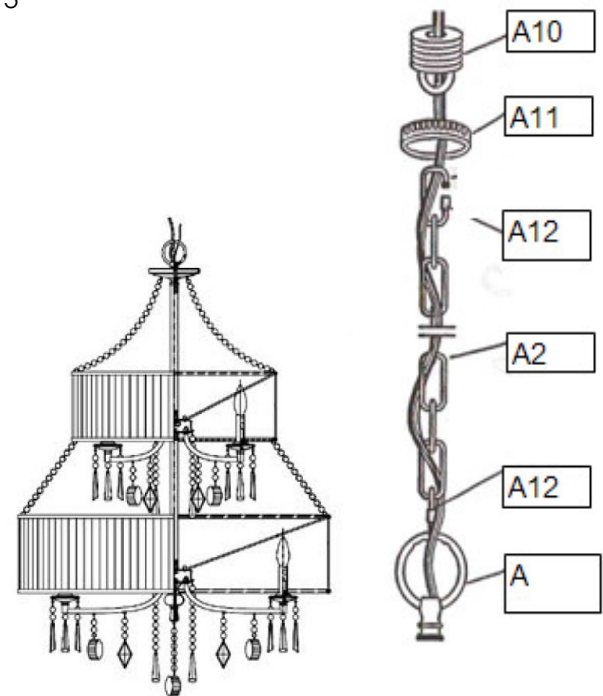
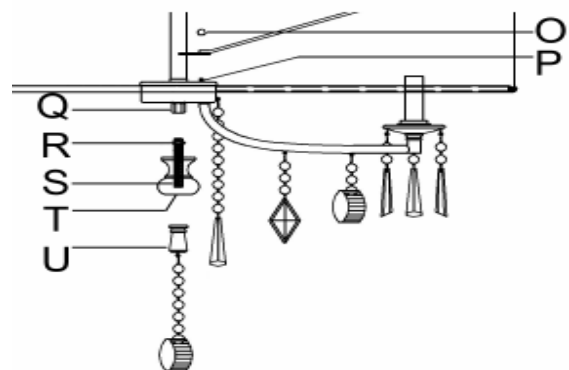

Fig 4



For Customer Service, contact the place of purchase to arrange for replacement parts.

WARNING ! SHUT OFF POWER AT FUSE OR CIRCUIT BREAKER.

HANGING THE FIXTURE (Fig.1)

1. Carefully remove the new fixture from the carton and the yellow bag that holds all parts. Check that all parts are included as shown in the illustration and parts list.
2. Shut off the power at the circuit breaker and remove old fixture from ceiling, including the old mounting strap.
3. Thread Nipple(A-8) into Canopy loop (A-11) until snug. Thread Hex nut (A-6) and Washer (A-5) on next.
4. Thread other end of the Nipple (A-8) with Canopy loop attached into Mounting strap (A-4) about 4 complete turns.
5. Tighten the Washer (A-5) and Hex Nut (A-6) until snug to the Mounting strap(A-4).
6. Take this mounting strap assembly and mount to ceiling junction box with Mounting Screws (A-7). Tighten screws securely with screw driver.
7. Unscrew the Canopy loop collar(A-10) from the Canopy loop. Take the canopy and pass over the Canopy loop. approximately one half of the canopy loop exterior threads should be exposed. Adjust until desired height is reached. *the Canopy loop collar should fit snugly on the Canopy loop after the canopy is installed. Remove Canopy and Canopy loop collar.
8. Assemble the fixture and have an assistant or secure support hold the weight of the fixture while you complete the wiring connections.
9. Thread the fixture wires and ground wire of the assembled fixture through the canopy loop and nipple and into the outlet box.

Fig. 1

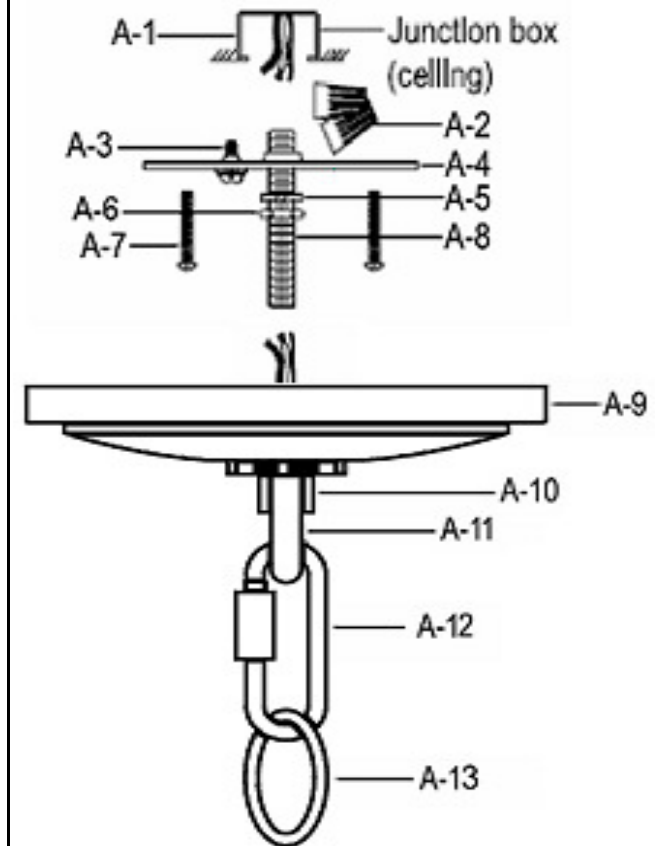

CONNECTING THE WIRES (Fig 2)

10. Attach the power supply wires to the fixture lead wires by connecting BLACK to BLACK (or SMOOTH) and WHITE to WHITE (or RIBBED).
 11. Attach the GROUND wire(GREEN or COPPER) from the Junction Box and the fixture Ground wire to the green Ground Screw on the Mounting Bracket (A-4) or connect both wires together using the correct size of wire connectors.
- NOTE: Twist the wires together in the same direction you twist the wire connector onto the wires.
12. Tuck these wire connections neatly into the Junction Box.

Fig. 2

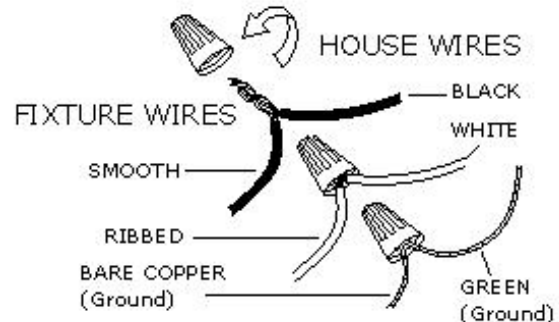

FINISHING THE INSTALLATION

13. Raise Canopy (A9) to the ceiling and secure in place by tightening the Canopy loop collar(A11) onto the Canopy Loop(10)
14. Install the light bulbs and shade as per the fixture assembly sheet.

**YOUR INSTALLATION IS NOW COMPLETE.
RETURN POWER TO THE JUNCTION BOX AND
TEST THE FIXTURE.**

CRYSTAL INSTRUCTION

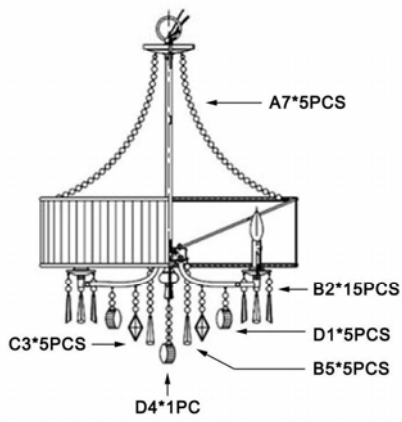

8981/5

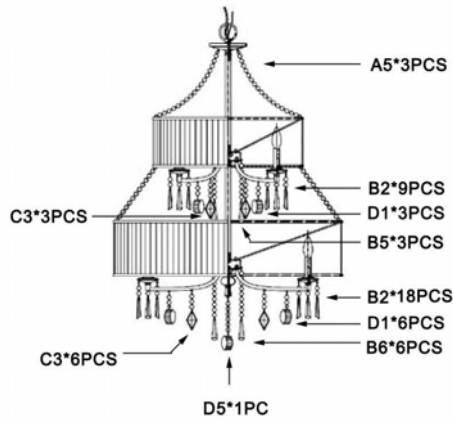

8981/9

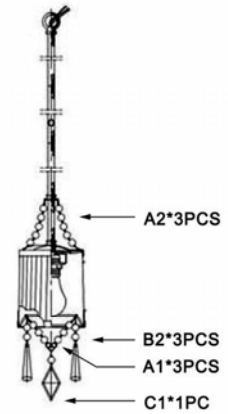

8981/M1L

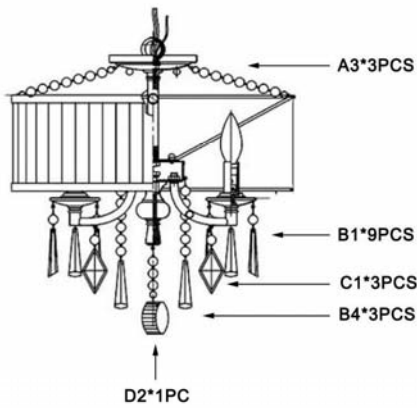

8981/SF

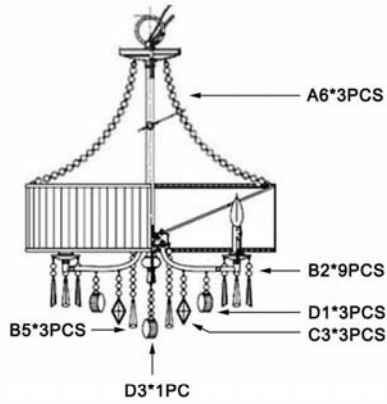

8981/3P

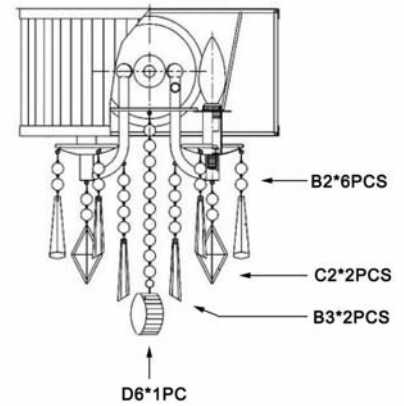

8981/WSC

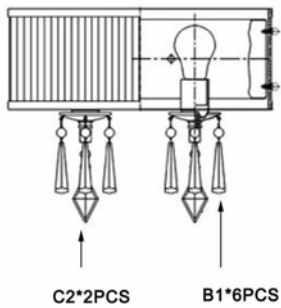

8981/BA2

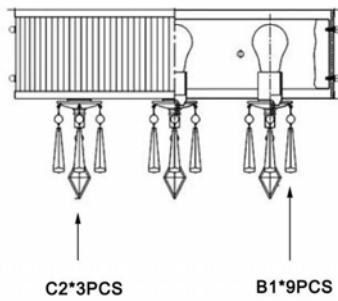

8981/BA3

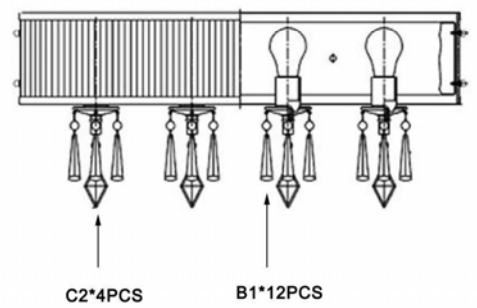

8981/BA4

