

vizia rf +™

DI-000-VRI06-02A



# Single Pole (One location) or 3-Way (Multi-location) Scene Capable Incandescent Dimmer

Cat. No. VRI06-1L, 600W (Lighted)  
120VAC, 60Hz  
**INSTALLATION INSTRUCTIONS**

**LEVITON®**

**WARNINGS AND CAUTIONS:**

- To be installed and/or used in accordance with appropriate electrical codes and regulations.
- If you are unsure about any part of these instructions, consult a qualified electrician.
- To avoid overheating and possible damage to this device and other equipment, do not install to control a receptacle, fluorescent lighting, a motor- or a transformer-operated appliance.
- Use with incandescent or 120V halogen fixtures only.
- Vizia RF +™ dimmers are not compatible with standard 3-way or 4-way switches. They must be used with compatible Vizia +™ or Vizia RF +™ remotes for multi-location dimming.
- Use only one (1) Vizia RF +™ dimmer in a multi-location circuit with up to 9 coordinating remotes (without LEDs) or up to 4 matching remotes (with LEDs). The remote(s) will turn the light on at the brightness level selected at the dimmer.

**WARNINGS AND CAUTIONS:**

- Dimmer may not operate with dioded lamps (Sylvania Designer 16™ or Philips PAR-16™).
- Total minimum load must exceed 40W.
- Dimmer may feel warm to the touch during normal operation.
- Recommended minimum wall box depth is 2-1/2".
- Maximum wire length from dimmer to all installed remotes cannot exceed 300 ft.
- Disconnect power at circuit breaker or fuse when servicing, installing or removing fixture.
- Use this device only with copper or copper clad wire. With aluminum wire use only devices marked CO/ALR or CU/AL.

**INTRODUCTION**

Leviton's Vizia RF +™ components are designed to communicate with each other via Radio Frequency (RF) to provide remote control of your lighting. Using RF technology allows Leviton to provide the greatest signal integrity possible. Each module in Leviton's Vizia RF +™ component line is a Z-Wave® enabled device. In a Z-Wave® network, each device is designed to act as a router. These routers will re-transmit the RF signal from one device to another until the intended device is reached. This ensures that the signal is received by its intended device by routing the signal around obstacles and radio dead spots. The Scene Capable Incandescent Dimmer is compatible with any Z-Wave® enabled network, regardless of the manufacturer and can also be used with other devices displaying the Z-Wave® logo.

**CAUTION:**

Remember to exercise good common sense when using the Timer features of your remote, especially when scheduling unattended devices. There can be some unexpected consequences if not used with care. For example, an empty coffee pot can be remotely turned on. If that should happen, your coffee pot could be damaged from overheating. If an electric heater is turned on by remote control while clothing is draped over it, a fire could result. **DO NOT USE** the remote for the control of high power heating appliances such as portable heaters. This device will not control lighting that is used with electronic low-voltage and high frequency power supply transformers, nor high pressure discharge lamps (HID lighting). This includes mercury-vapor, sodium vapor and metal halide lamps.

**FEATURES**

- Soft fade ON/OFF
- Scene capable
- Two way communication
- RF reliability
- No Neutral wire required
- ON/OFF LED and Brightness level LED
- Ease of installation – No new wiring
- Compatible with other Z-Wave® enabled devices

**Tools needed to install your Dimmer**

- Slotted/Phillips Screwdriver
- Pliers
- Cutters
- Electrical Tape
- Pencil
- Ruler

**Changing the color of your Dimmer:**

Your device may include color options. To change color of the face, proceed as follows:

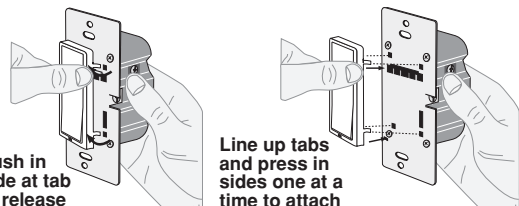

**Installing Dimmer by itself or with other devices**

If installing Dimmer in a single device application, proceed with the **INSTALLING YOUR DIMMER** section. If installing Dimmer in a multi-device application, proceed as follows:

**MULTI-DEVICE APPLICATION:**

In multi-dimmer installations, the reduction of the dimmer's capacity is required. Refer to the chart for maximum load per dimmer.

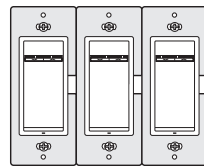

MAXIMUM LOAD PER DIMMER FOR MULTI-DEVICE			
Cat. No.	Single	Two Devices	More than 2 Devices
VRI06	600W	500W	400W

**INSTALLING YOUR DIMMER**

**NOTE:** Use check boxes  when Steps are completed.

**Step 1 WARNING: TO AVOID FIRE, SHOCK, OR DEATH; TURN OFF POWER** at circuit breaker or fuse and test that power is off before wiring!



**Step 2 Identifying your wiring application (most common):**

**NOTE:** If the wiring in the wall box does not resemble any of these configurations, consult a qualified electrician.

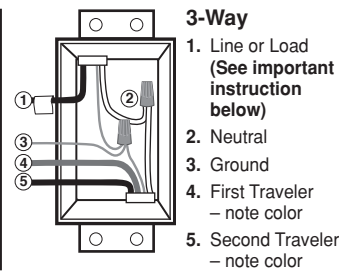
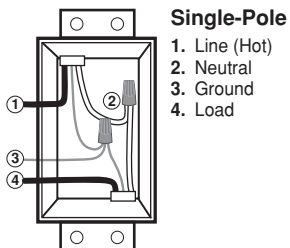

**IMPORTANT:** For 3-Way applications, note that one of the screw terminals from the old switch being removed will usually be a different color (Black) or labeled Common. Tag that wire with electrical tape and identify as the common (Line or Load) in both the dimmer wall box and remote wall box.

**Step 3 Preparing and connecting wires:**

This dimmer can be wired using side wire terminal screws or through backwire openings. Choose appropriate wire stripping specifications accordingly.

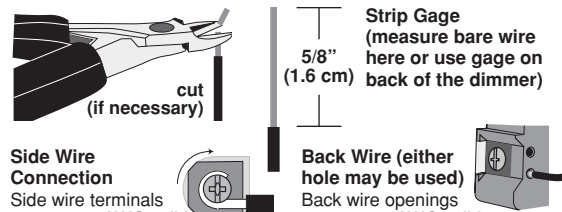

**Side Wire Connection**

Side wire terminals accept #14 AWG solid copper wire only.

- Make sure that the ends of the wires from the wall box are **straight (cut if necessary)**.
- Remove insulation from each wire in the wall box as shown.
- **For Single Pole Application, go to Step 4a.**
- **For 3-Way Coordinating Remote (no LEDs) Application, go to Step 4b.**
- **For 3-Way Matching Remote (with LEDs) Application, go to Step 4c.**

**Step 4a Single-Pole Wiring Application:**

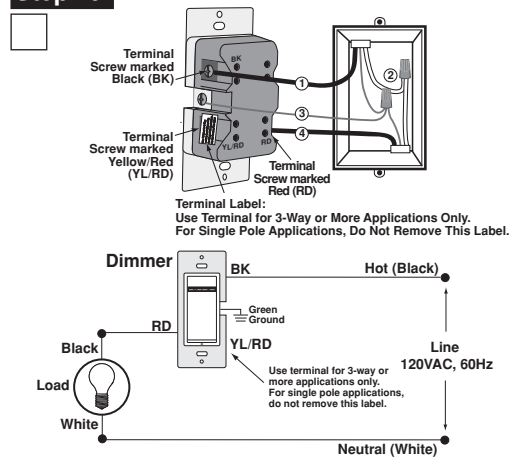

**WIRING DIMMER:**

**Connect wires per WIRING DIAGRAM as follows:**

- Green or bare copper wire in wall box to Green terminal screw.
- Line Hot wall box wire to terminal screw marked "BK".
- Load wall box wire to terminal screw marked "RD".
- Dimmer terminal screw marked "YL/RD" should have Red insulation label affixed.
- NOTE:** If insulating label is not affixed to terminal screw marked "YL/RD", use electrical tape to cover.
- **Proceed to Step 5.**

**Step 4b 3-Way Wiring with Coordinating Remote (no LEDs) Application:**

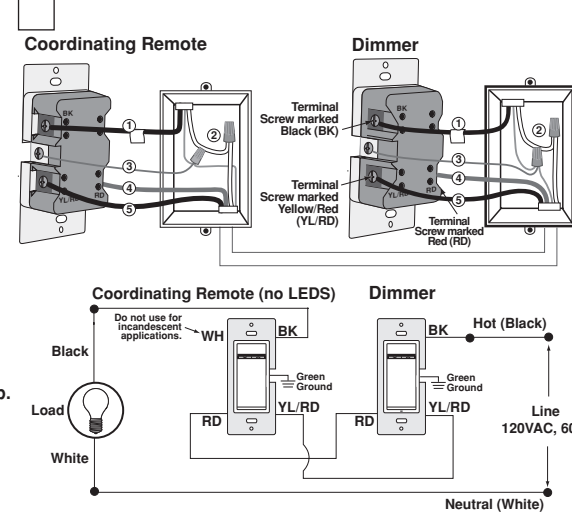

**WIRING DIMMER:**

**Connect wires per WIRING DIAGRAM as follows:**

- **NOTE:** When using the coordinating remote without LEDs, the dimmer can be installed on either the Line or Load side of the 3-way circuit.
- **NOTE:** Maximum wire length from dimmer to all installed remotes cannot exceed 300 ft.
- Green or bare copper wire in wall box to Green terminal screw.
- Line Hot (common) wall box wire identified (tagged) when removing old switch to terminal screw marked "BK".
- First Traveler wall box wire to terminal screw marked "RD" (note wire color). This traveler from the dimmer must go to the terminal screw on the remote marked "RD".
- Remove Red insulating label from terminal screw marked "YL/RD".
- Second Traveler wall box wire to terminal screw marked "YL/RD" (note wire color). This traveler from the dimmer must go to the terminal screw on the remote marked "YL/RD".

**WIRING COORDINATING REMOTE:**

**Connect wires per WIRING DIAGRAM as follows:**

- **NOTE:** Maximum wire length from dimmer to last remote is 300ft.
- Green or bare copper wire in wall box to Green terminal screw.
- Load wall box wire identified (tagged) when removing old switch to terminal screw marked "BK".
- First Traveler wall box wire (note color as above) to terminal screw marked "RD". This traveler from the remote must go to the terminal screw on the dimmer marked "RD".
- Second Traveler wall box wire (note color as above) to terminal screw marked "YL/RD". This traveler from the remote must go to the terminal screw on the dimmer marked "YL/RD".
- Remote terminal screw marked "WH" should have White insulation label affixed.
- NOTE:** If insulating label is not affixed to terminal screw marked "WH", use electrical tape to cover.
- **Proceed to Step 5.**

**Step 4c 3-Way Wiring with Matching Remote (w/LEDs) Application:**

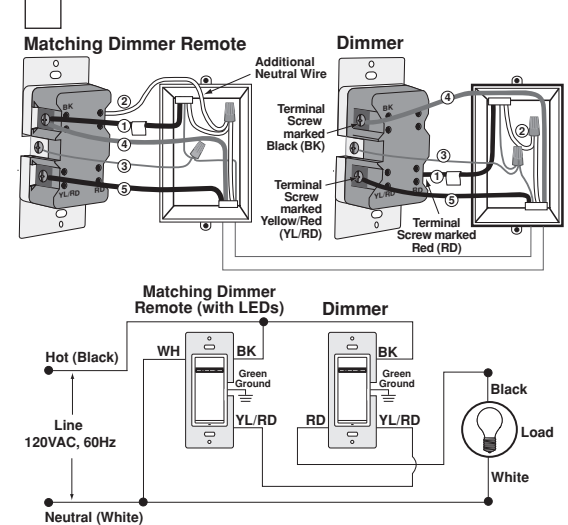

**NOTE:** The dimmer **must** be installed in a wall box that has a Load connection. The matching remote **must** be installed in a wall box with a Line Hot connection and a Neutral connection. A Neutral wire to the matching remote needs to be added as shown. If you are unsure about any part of these instructions, consult a qualified electrician.

**NOTE:** Maximum wire length from dimmer to all installed remotes cannot exceed 300 ft.

**WIRING MATCHING REMOTE (wall box with Line Hot connection):**

**Connect wires per WIRING DIAGRAM as follows:**

- Green or bare copper wire in wall box to Green terminal screw.
- Line Hot (common) wall box wire identified (tagged) when removing old switch and First Traveler to remote terminal screw marked "BK".
- Second Traveler wall box wire from dimmer to remote terminal screw marked "YL/RD" (note wire color). This traveler from the remote must go to the terminal screw on the dimmer marked "YL/RD".
- Line Neutral wall box to remote terminal screw marked "WH".

**WIRING DIMMER (wall box with Load connection):**

**Connect wires per WIRING DIAGRAM as follows:**

- Green or bare copper wire in wall box to Green terminal screw.
- Load wall box wire identified (tagged) when removing old switch to dimmer terminal screw marked "RD".
- First Traveler Line Hot to dimmer terminal screw marked "BK".
- Remove Red insulating label from terminal screw marked "YL/RD".
- Second Traveler wall box wire (note color as above) to dimmer terminal screw marked "YL/RD". This traveler from the dimmer must go to the terminal screw on the remote marked "YL/RD".
- **Proceed to Step 5.**

**Step 5 Testing your Dimmer prior to mounting in wall box:**

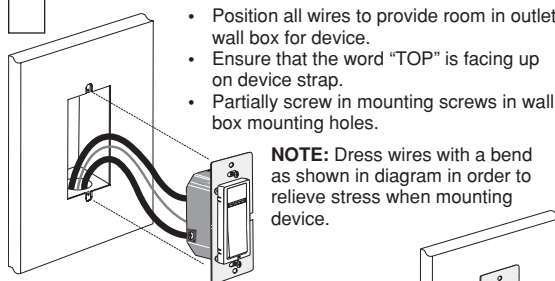

- Position all wires to provide room in outlet wall box for device.
  - Ensure that the word "TOP" is facing up on device strap.
  - Partially screw in mounting screws in wall box mounting holes.
- NOTE:** Dress wires with a bend as shown in diagram in order to relieve stress when mounting device.

**Step 6 Dimmer Mounting: TURN OFF POWER AT CIRCUIT BREAKER OR FUSE.**



**Step 7 Restore Power:** Restore power at circuit breaker or fuse. Installation is complete.

**Step 8 Including Scene Capable Dimmer into Z-Wave® Network:**

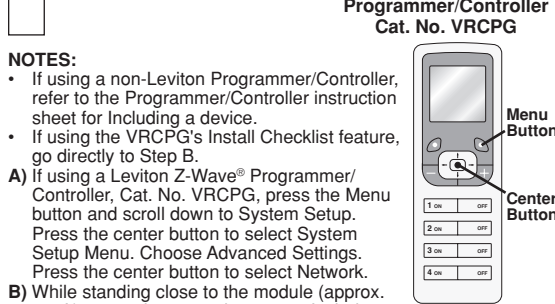

- NOTES:**
- If using a non-Leviton Programmer/Controller, refer to the Programmer/Controller instruction sheet for Including a device.
  - If using the VRCPCG's Install Checklist feature, go directly to Step B.
- A)** If using a Leviton Z-Wave® Programmer/Controller, Cat. No. VRCPCG, press the Menu button and scroll down to System Setup. Press the center button to select System Setup Menu. Choose Advanced Settings. Press the center button to select Network.
- B)** While standing close to the module (approx. 2-5 ft), press the center button to <Include> device in the network.
- NOTE:** Only one device may be included at a time. **DO NOT** put multiple devices into the Inclusion mode at any time.
- C)** While the Programmer/Controller is in the Inclusion mode and the Locator LED is ON on the dimmer, push the push pad to turn ON the dimmer. The Programmer/Controller will verify inclusion and the locator LED will turn OFF on the dimmer. If the dimmer is flashing Amber while in the Inclusion mode, the Programmer/Controller is still trying to communicate with the dimmer. Wait until the device stops flashing, then press push pad.
- NOTE:** If the locator LED on the dimmer turns solid Red while including, there has been a communication error. Refer to Troubleshooting section.

- D)** The Primary Programmer/Controller will assign a node ID number (Name) for this module.
- NOTE:** This ID number (Name) will be stored in the controller library to be used for future reference.
- NOTE:** You may edit the name of this device at this time.
- E) The dimmer is now installed in the network.**
- NOTE:** If a dimmer has been successfully Included in the network and the user tries to Include it again without first excluding it from the network, the module will retain the first node ID it had received and ignore the second.

**Step 9 Excluding Dimmer from Network:**

- NOTE:** It is very important to accurately Exclude devices from the network when moving or removing a device from a Z-Wave® network. This ensures that all information has been removed from your Primary Programmer/Controller's information table and is not counted on to be a part of the mesh network.
- A)** If using a Leviton Z-Wave® Programmer/Controller, Cat. No. VRCPCG, press the Menu button and scroll down to System Setup. Press the center button to select System Setup Menu. Choose Advanced Settings. Press the center button to select Network.
- B)** While standing close to the dimmer, press the center button to <Exclude> device from the network. While the Programmer/Controller is in the Exclusion mode and the locator LED is ON on the dimmer, press the push pad on the dimmer. The Programmer/Controller will verify Exclusion and the locator LED will turn OFF on the dimmer. If the dimmer is flashing Amber while in the Exclusion mode, the Programmer/Controller is still trying to communicate with the dimmer. Wait until the device stops flashing, then press the push pad.

- Factory Default:**
- If your dimmer is not responding, or you are unable to control it after you have tried to Include/Exclude it multiple times, it may be necessary to reset the dimmer to its original factory settings. To accomplish this, proceed as follows:
- On the dimmer, engage the air-gap switch (refer to Operation section) and wait 5 seconds. Press push pad back into frame and hold push pad until the locator LED turns Amber and then flashes Red. The dimmer is now reset. Once the dimmer is reset, it will be necessary to Re-Include it to a network before it can be used.
- CAUTION:** SETTING A DEVICE TO A FACTORY DEFAULT DOES NOT EXCLUDE THAT DEVICE FROM A NETWORK. THE EXCLUSION PROCEDURE MUST STILL BE FOLLOWED TO REMOVE THE DEVICE FROM THE PRIMARY CONTROLLER'S INFORMATION TABLE. FAILURE TO DO SO MAY RESULT IN A SYSTEM THAT IS SLOW TO RESPOND, OR MAY FAIL TO RESPOND TO SOME DEVICES.

**OPERATION**

- NOTE:** The locator light will illuminate when the load is in the OFF position to facilitate access in the dark.
- NOTE:** If using the dimmer in a 3-way application, the lights will turn ON at brightness set on dimmer's DIM/BRIGHT bar. The lighting can be controlled from either the dimmer or the remote location.
- Push Pad (Default settings):**  
**Turn ON from OFF position:** Tap – Lights turn ON to preset level. Press and Hold – Lights turn ON to full bright.  
**Turn OFF from ON position:** Tap – Lights turn OFF.

- DIM/BRIGHT Bar BRIGHTEN:** Press right half of DIM/BRIGHT Bar – Lights brighten to desired level.
- DIM:** Press left half of DIM/BRIGHT Bar – Lights dim to desired level. If you continue to hold the lower half of the DIM/BRIGHT Bar, the lights will DIM to minimum level and then turn OFF.
- NOTE:** When lights are OFF you can change the light level that the lights will turn ON to using the DIM/BRIGHT Bar.
- If there is a power outage, when the power is restored the lights will return to the last setting before the power interruption.
- Air-Gap Switch:** On the dimmer only, engage the air-gap switch by gently pressing the top of the push pad until the bottom lifts completely out of the frame and a click is heard (refer to Figure). LEDs will turn OFF. This will cut power to the fixture to replace the bulb. After servicing is complete, push the push pad back for normal operation.
- Cleaning:** Clean with a damp cloth. **DO NOT** use chemical cleaners.

**ADVANCED PROGRAMMING FEATURES**

- Definition of A Modes**
- A-1) Energy Save:** Sets the maximum brightness level for energy savings.
- A-2) Minimum Brightness Level:** Sets the minimum dimming level.
- A-3) Preset ON Level:** Sets the turn on brightness level regardless of the previous set light level (formerly Dim Lock).
- Definition of B Modes**
- B-1) ON Fade Rate:** Sets the amount of time in seconds it takes the lights to turn ON to maximum brightness.
- B-2) OFF Fade Rate:** Sets the amount of time in seconds it takes the lights to turn OFF from maximum brightness.
- B-3) LED Options:** Sets the time period in seconds the Locator LED and Brightness display will stay on before extinguishing.

- Definition of LEDs**
- Leftmost LED = LED 1  
 Rightmost LED = LED 7
- NOTES:**
- The device will exit programming mode after 3 minutes of inactivity.
  - Pressing the push pad at any time during programming will advance the device to the next programming mode.

- Program Mode A**
- To enter Program Mode A:** Press and hold the Push Pad and then the **right** half of the DIM/BRIGHT Bar (^) for 5 seconds until the Locator LED and leftmost LED (LED 1) begin to blink.
- A-1)** Upon releasing the Push Pad and the **right** half of the DIM/BRIGHT Bar (^), the Locator LED will continue to blink once per second and the rightmost LED will illuminate to display the device is in Program Mode **A-1, Energy Save**. The default energy save mode is 100% i.e. full bright. To change the **Energy Save** level, use the DIM/BRIGHT Bar to move the corresponding LED to the desired discrete preset level according to **Chart A**. By tapping the Push Pad this setting will automatically be saved and the device will advance to the next programming mode, **A-2**.

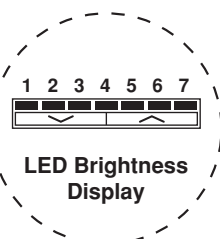
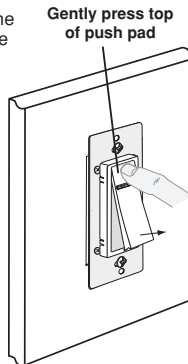

**Chart A**

When indicator light is at LED #	Light output is at	Energy consumption savings amounts to
7	100%	0%
6	97%	5%
5	95%	8%
4	90%	11%
3	85%	14%
2	80%	17%
1	75%	20%

- A-2)** The Locator LED will blink 2 times per second to indicate the device is in Program Mode **A-2, Minimum Brightness Level**. To change the **Minimum Brightness Level** from 1-50%, use the DIM/BRIGHT Bar. The light output will reflect the minimum brightness level selected. By tapping the Push Pad this setting will automatically be saved and the device will advance to the next programming mode, **A-3**.
- A-3)** The Locator LED will blink 3 times per second to indicate Program Mode **A-3, Preset ON Level**. To change the current **Preset ON Level** from 1-100%, use the DIM/BRIGHT Bar. If this feature is not desired, press and hold the **left** half of the DIM/BRIGHT Bar (v) until no LED is lit (default setting). By tapping the Push Pad this setting will automatically be saved and the device will exit Programming Mode A.

- Program Mode B**
- To enter Program Mode B:** Press and hold the Push Pad and then the **left** half of the DIM/BRIGHT Bar (v) for 5 seconds until the Locator LED and rightmost LED (LED 7) begin to blink.
- B-1)** Upon releasing the Push Pad and the **left** half of the DIM/BRIGHT Bar (v), the Locator LED will continue to blink once per second indicating he dimmer is in Program Mode **B-1, ON Fade Rate**. To change the **ON Fade Rate**, use the DIM/BRIGHT Bar to move the LED to the desired preset level according to **Chart B**. By tapping the Push Pad this setting will automatically be saved and the device will advance to the next programming mode, **B-2**.
- B-2)** The Locator LED will blink 2 times per second to indicate Program Mode **B-2, OFF Fade Rate**. To change the **OFF Fade Rate**, use the DIM/BRIGHT Bar to move the LED to the desired preset level according to **Chart B**. By tapping the Push Pad this setting will automatically be saved and the device will advance to the next programming mode, **B-3**.

**Chart B**

LED	FADE ON	FADE OFF
LED 1	0 seconds (instant)	0 seconds (instant)
LED 2 (Default)	0.5 seconds	0.5 seconds
LED 3	1.5 seconds	1.5 seconds
LED 4	3.0 seconds	3.0 seconds
LED 5	6.0 seconds	6.0 seconds
LED 6	10 seconds	10 seconds
LED 7	25 seconds	25 seconds

- B-3)** The Locator LED will blink 3 times per second to indicate Program Mode **B-3, LED Options**. To change the **LED Options** settings, use the DIM/BRIGHT Bar to move the LED to the desired preset setting according to the **Chart B-3**. By tapping the Push Pad this setting will automatically be saved and the device will exit Programming Mode B.

**Chart B-3**

LED	LOCATOR LED TIMEOUT	LED BRIGHTNESS DISPLAY OPTIONS
LED 1	Active	Active
LED 2	Active	Turns off 5 sec. after use
LED 3	Turns off 5 sec. after use	Active
LED 4	Turns off 5 sec. after use	Turns off 5 sec. after use
LED 5	Active	LED Bar active
LED 6	Active	LED Bar turns off 5 sec. after use
LED 7	Turns off 5 sec. after use	LED Bar turns off 5 sec. after use

**TROUBLESHOOTING**

- **Lights Flickering**
  - Lamp has a bad connection.
  - Wires not secured firmly under terminal screws of dimmer and/or remote.
  - Local switch, ON
- **Light does not turn ON and Locator LED does not turn ON**
  - Circuit breaker or fuse has tripped.
  - Lamp is burned out.
  - Lamp Neutral connection is not wired.
  - Confirm that the device is being supplied from a 120V, 60Hz AC source ONLY.
  - Confirm that unit is programmed properly. Repeat "TO INSTALL" section to verify that it has been included in the Z-Wave™ network.
- **Intermittent dimmer operation**
  - Minimum load is under 40W.
  - Confirm that the Load being controlled does not exceed the 600W dimmer limit.
- **Remote does not operate lights**
  - Ensure that total wire length does not exceed 300 ft.

For additional information, contact Leviton's Techline at 1-800-824-3005 or visit Leviton's website at [www.ViziaRF+.com](http://www.ViziaRF+.com)

**FCC COMPLIANCE STATEMENT**

This equipment has been tested and found to comply with the limits for a Class B Digital Device, pursuant to Part 15 of the FCC Rules. These limits are designed to provide reasonable protection against harmful interference in a residential installation. This equipment generates, uses, and can radiate radio frequency energy and, if not installed and used in accordance with the instructions, may cause harmful interference to radio communications. However, there is no guarantee that interference will not occur in a particular installation. If this equipment does cause harmful interference to radio or television reception, which can be determined by turning the equipment OFF and ON, the user is encouraged to try to correct the interference by one or more of the following measures:

- Reorient or relocate the receiving Antenna.
- Increase the separation between the equipment and the receiver.
- Connect the equipment into an outlet on a circuit different from that to which the receiver is connected.
- Consult the dealer or an experienced radio/tv technician for help.

Protected under U.S. Patent Number 6,388,399 and patents pending and licensed under U.S. Patents Numbers 5,905,442, and 5,982,103

2008 © Leviton Mfg. Co., Inc. DI-000-VRI06-02A

**LIMITED 5 YEAR WARRANTY AND EXCLUSIONS**

Leviton warrants to the original consumer purchaser and not for the benefit of anyone else that this product at the time of its sale by Leviton is free of defects in materials and workmanship under normal and proper use for five years from the purchase date. Leviton's only obligation is to correct such defects by repair or replacement, at its option, if within such five year period the product is returned prepaid, with proof of purchase date, and a description of the problem to Leviton Manufacturing Co., Inc., Att: Quality Assurance Department, 59-25 Little Neck Parkway, Little Neck, New York 11362-2591. This warranty excludes and there is disclaimed liability for labor for removal of this product or reinstallation. This warranty is void if this product is installed improperly or in an improper environment, overloaded, misused, opened, abused, or altered in any manner, or is not used under normal operating conditions or not in accordance with any labels or instructions. There are no other or implied warranties of any kind, including merchantability and fitness for a particular purpose, but if any implied warranty is required by the applicable jurisdiction, the duration of any such implied warranty, including merchantability and fitness for a particular purpose, is limited to five years. Leviton is not liable for incidental, indirect, special, or consequential damages, including without limitation, damage to, or loss of use of, any equipment, lost sales or profits or delay or failure to perform this warranty obligation. The remedies provided herein are the exclusive remedies under this warranty, whether based on contract, tort or otherwise.