

Philips MasterColor® Ceramic Metal Halide PAR Lamps



© 2005 Photography by Josh Ederbaum

Ideal for retail accent and display lighting and architectural lighting for interior and exterior applications

▶ Excellent Color Rendering

81–85 for 3K; 92–93 for 4K

▶ Superior Color Stability

Within $\pm 200\text{K}$

▶ Lamp to Lamp Color Consistency Over life

▶ Higher Lumen Maintenance

Improved lumen maintenance over standard metal halide

▶ Reduced Lighting Cost of Ownership Benefits

- Energy-efficient alternative to incandescent/halogen
- Operate on existing ballasts

▶ FadeBlock™

Lamps feature integrated UV blocking medium for reduced fading of fabrics and paintings



PHILIPS

MasterColor® Spectral Power Distribution

Representative Spectral Power Distribution of MasterColor® 3K Lamps

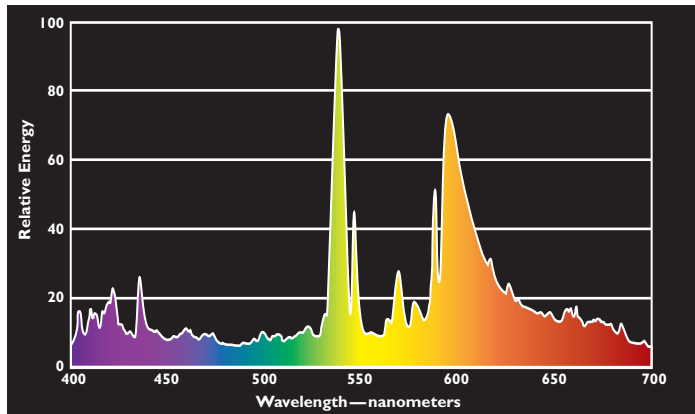

Representative Spectral Power Distribution of MasterColor® 4K Lamps

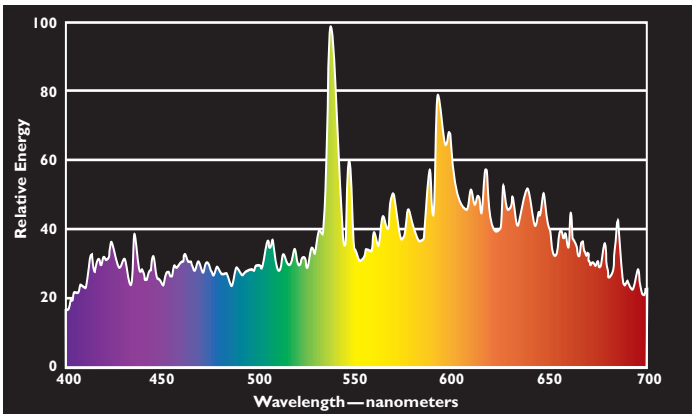

Superior Color Stability

Graphs depict test data showing actual range of lamp color temperatures vs. published values (for 100 watt lamps).

MasterColor® vs. Most Competitive Quartz 3K Lamps

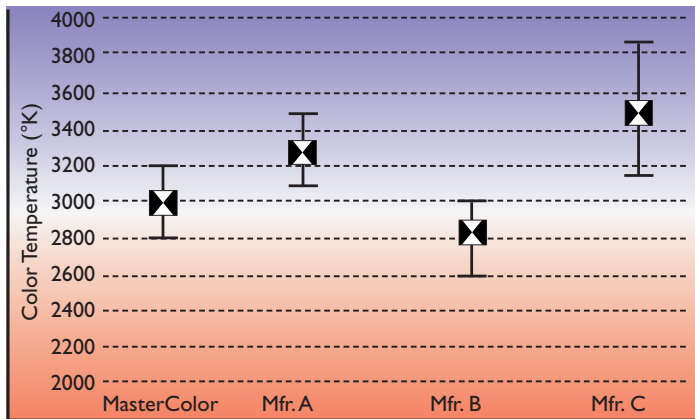

☒ Manufacturer's published values

MasterColor® vs. Most Competitive Quartz 4K Lamps

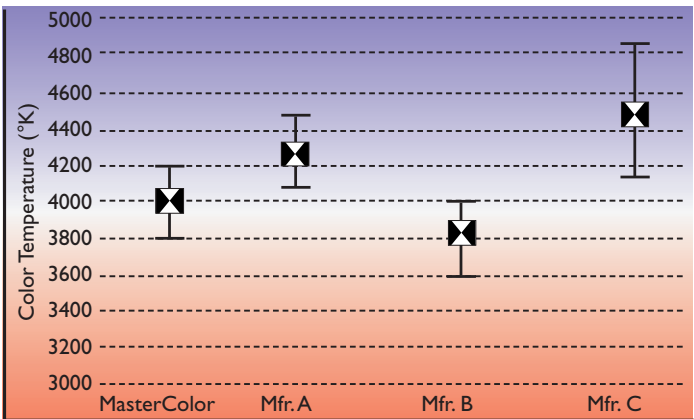

☒ Manufacturer's published values

MasterColor® Survival Curve

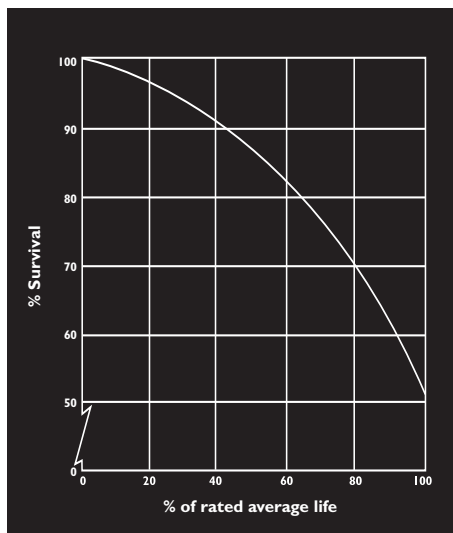

Lumen Maintenance: MasterColor® vs. Most Competitive 3K or 4K Quartz Metal Halide Lamps

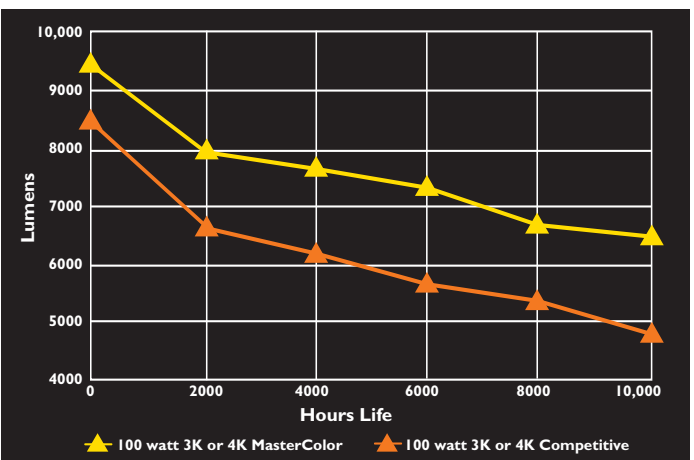

Lamp Dimensions (mm/in.)

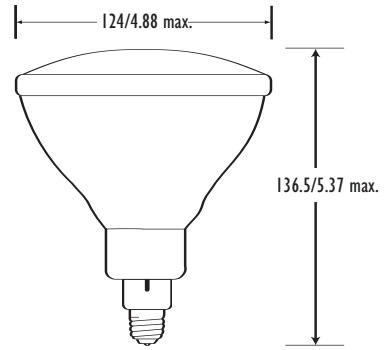
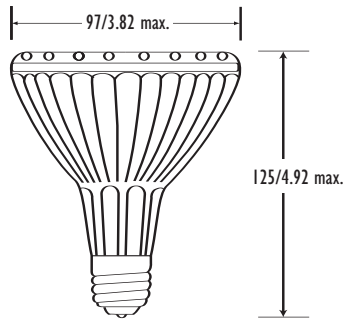
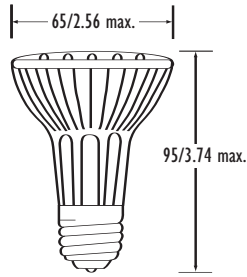

Beam spread at 50% Maximum Beam Candlepower—0° primary angle FC=Footcandles at mounting height ø=Beam diameter at mounting height

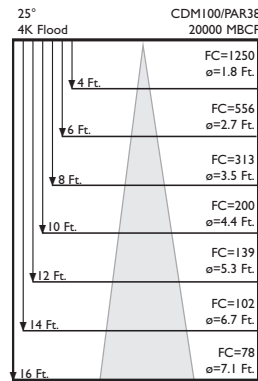
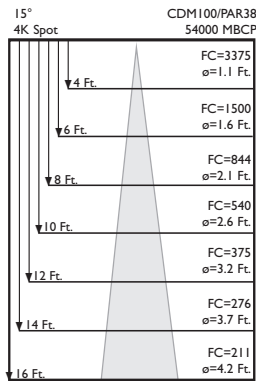
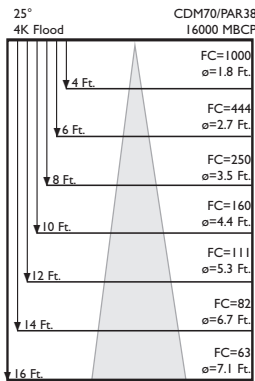
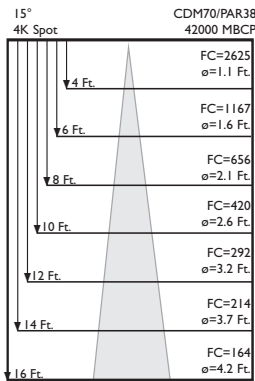
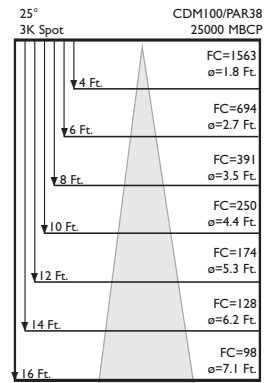
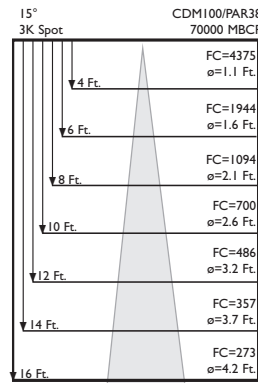
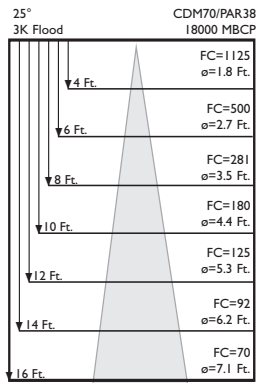
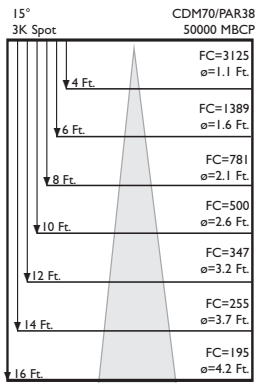
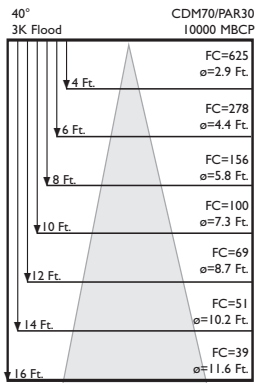
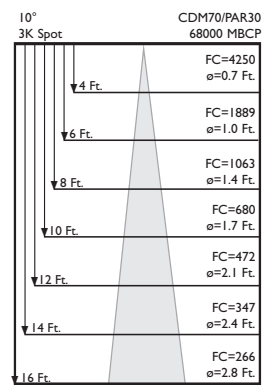
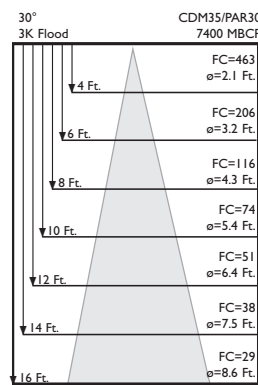
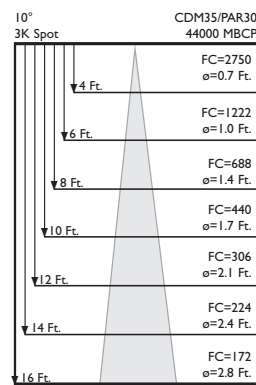
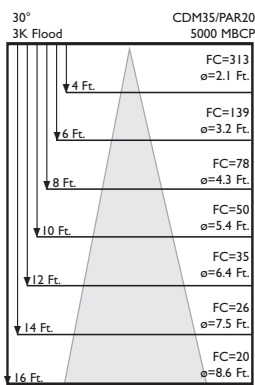
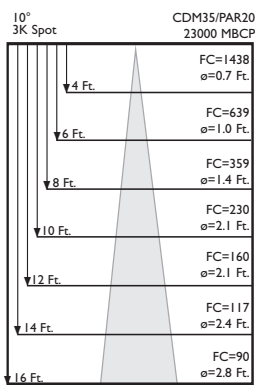

MasterColor® Ceramic Metal Halide PAR Lamps

Electrical, Technical and Ordering Data (Subject to change without notice)

Product Number	Ordering Code	ANSI Code	Watts	Bulb	Base	Std. Pkg. Qty.	LCL (In.)	MOL (In.)	Rated Avg. Life (Hrs) ¹	Approx. Initial Lumens ²	Approx. Mean Lumens ³	CRI	CCT	Beam Description
23365-0	CDM35/PAR20/M/SP/3K ^{4,5,6}	M130/O	39	PAR-20	Med.	12	—	3 3/8	9000	2000	1300	81	3000	Spot 10°
23364-3	CDM35/PAR20/M/FL/3K ^{4,5,6}	M130/O	39	PAR-20	Med.	12	—	3 3/8	9000	2000	1300	81	3000	Flood 30°
15140-7	CDM35/PAR20/M/SP/4K ^{4,5,7}	M130/O	39	PAR-20	Med.	12	—	3 3/8	6000	1950	1650	92	4000	Spot 10°
15141-5	CDM35/PAR20/M/FL/4K ^{4,5,7}	M130/O	39	PAR-20	Med.	12	—	3 3/8	6000	1950	1650	92	4000	Flood 30°
22329-7	CDM35/PAR30L/M/SP/3K ^{4,5,6}	M130/O	39	PAR-30L	Med.	6	—	4 3/8	9000	2200	1430	81	3000	Spot 10°
22330-5	CDM35/PAR30L/M/FL/3K ^{4,5,6}	M130/O	39	PAR-30L	Med.	6	—	4 3/8	9000	2200	1430	81	3000	Flood 30°
23224-9	CDM70/PAR30L/M/SP/3K ^{4,5,6}	M143/M98/O	70	PAR-30L	Med.	6	—	4 3/8	11,000	5000	3050	83	3000	Spot 10°
23221-5	CDM70/PAR30L/M/FL/3K ^{4,5,6}	M143/M98/O	70	PAR-30L	Med.	6	—	4 3/8	11,000	5000	3050	83	3000	Flood 40°
15142-3	CDM70/PAR30L/M/SP/4K ^{4,5,7}	M139/O	70	PAR-30L	Med.	6	—	4 3/8	9000	4300	3010	94	4000	Spot 10°
15143-1	CDM70/PAR30L/M/FL/4K ^{4,5,7}	M139/O	70	PAR-30L	Med.	6	—	4 3/8	9000	4300	3010	94	4000	Flood 40°
● 22250-5	CDM70/PAR38/SP/3K/ALTO ^{4,5,6}	M143/M98/O	70	PAR-38	Med.	12	—	5 3/8	12,500	4100	2870	85	3000	Spot 15°
● 22249-7	CDM70/PAR38/FL/3K/ALTO ^{4,5,6}	M143/M98/O	70	PAR-38	Med.	12	—	5 3/8	12,500	4100	2870	85	3000	Flood 25°
● 28872-0	CDM70/PAR38/SP/4K/ALTO ^{4,5,6}	M143/M98/O	70	PAR-38	Med.	12	—	5 3/8	12,500	3700	2590	92	4000	Spot 15°
● 28873-8	CDM70/PAR38/FL/4K/ALTO ^{4,5,6}	M143/M98/O	70	PAR-38	Med.	12	—	5 3/8	12,500	3700	2590	92	4000	Flood 25°
● 24477-2	CDM100/PAR38/SP/3K/ALTO ^{4,5,6}	M140/M90/O	100	PAR-38	Med.	12	—	5 3/8	12,500	6200	4340	85	3000	Spot 15°
● 24476-4	CDM100/PAR38/FL/3K/ALTO ^{4,5,6}	M140/M90/O	100	PAR-38	Med.	12	—	5 3/8	12,500	6200	4340	85	3000	Flood 25°
● 28876-1	CDM100/PAR38/SP/4K/ALTO ^{4,5,6}	M140/M90/O	100	PAR-38	Med.	12	—	5 3/8	12,500	5700	3990	92	4000	Spot 15°
● 28878-7	CDM100/PAR38/FL/4K/ALTO ^{4,5,6}	M140/M90/O	100	PAR-38	Med.	12	—	5 3/8	12,500	5700	3990	92	4000	Flood 25°

1) Rated average life is the life obtained, on the average, from large representative groups of lamps in laboratory tests under controlled conditions at 10 or more operating hours per start.

It is based on survival of at least 50% of the lamps and allows for individual lamps or groups of lamps to vary considerably from the average.

2) Measured at 100 hours life. Approximate lumen values listed are for vertical operation of the lamp.

3) Approximate lumen output at 40% of lamp rated average life.

4) Requires a ballast specified or approved for Philips Metal Halide lamp or one designed to the indicated ANSI Standard. A pulse ignitor is required. Sockets and wiring must withstand starting pulse.

5) Supply volts must be ±5% of rated ballast line volts for reactor type and ±10% for CWA or electronic ballasts.

6) Operate only on thermally protected ballasts.

7) Operate only on thermally protected electronic ballasts.

● This lamp is better for the environment because of its reduced mercury content. All Philips ALTO® lamps give you end-of-life options which can simplify and reduce your lamp disposal costs depending on your state and local regulations.

WARNINGS, CAUTIONS AND OPERATING INSTRUCTIONS

R“WARNING: These lamps can cause serious skin burn and eye inflammation from short wave ultraviolet radiation if outer envelope of the lamp is broken or punctured. Do not use where people will remain for more than a few minutes unless adequate shielding or other safety precautions are used. Certain lamps that will automatically extinguish when the outer envelope is broken or punctured are commercially available.” This lamp complies with FDA radiation performance standard 21 CFR subchapter J. (USA: 21CFR 1040.30 Canada: SOR/DORS/80-381)

If the outer bulb is broken or punctured, turn off at once and replace the lamp to avoid possible injury from hazardous short wave ultraviolet radiation. Do not scratch the outer bulb or subject it to pressure as this could cause the outer bulb to crack or shatter. A partial vacuum in the outer bulb may cause glass to fly if the envelope is struck.

WARNING: The arc-tube of metal halide lamps are designed to operate under high pressure and at temperatures up to 1000° C and can unexpectedly rupture due to internal or external factors such as a ballast failure or misapplication. If the arc-tube ruptures for any reason, the outer bulb may break and pieces of extremely hot glass might be discharged into the surrounding environment. If such a rupture were to happen, **THERE IS A RISK OF PERSONAL INJURY, PROPERTY DAMAGE, BURNS AND FIRE.** These lamps are designed to retain all the glass particles should an arc tube rupture occur. The following operating instructions are recommended to minimize these occurrences.

RELAMP FIXTURES AT OR BEFORE THE END OF RATED LIFE. Allowing lamps to operate until they fail is not advised and may increase the possibility of inner arc tube rupture.

This lamp contains an arc tube with a filling gas containing Kr-85 and is distributed by Philips Lighting Company, a division of Philips Electronics North America Corporation, Somerset, New Jersey, 08875.



CAUTION: TO REDUCE THE RISK OF PERSONAL INJURY, PROPERTY DAMAGE, BURNS AND FIRE RESULTING FROM AN ARC-TUBE RUPTURE THE FOLLOWING **LAMP OPERATING INSTRUCTIONS** MUST BE FOLLOWED:

LAMP OPERATING INSTRUCTIONS:

- RELAMP FIXTURES AT OR BEFORE THE END OF RATED LIFE. Allowing lamps to operate until they fail is not advised and may increase the possibility of inner arc tube rupture.
- Before lamp installation/replacement, shut power off and allow lamp and fixture to cool to avoid electrical shock and potential burn hazards.
- Use only auxiliary equipment meeting Philips and/or ANSI standards. Use within voltage limits recommended by ballast manufacturer.
 - Operate lamp only within specified limits of operation.
 - For total supply load refer to ballast manufacturers electrical data.
- C. Operate Par 20 3000K and Par 30L 3000K lamps only on thermally protected ballasts**
- D. Operate Par 20 4000K and Par 30L 4000K lamps only on thermally protected electronic ballasts**
- Periodically inspect the outer envelope. Replace any lamps that show scratches, cracks or damage.
- If a lamp bulb support is used, be sure to insulate the support electrically to avoid possible decomposition of the bulb glass.
- Protect lamp base, socket and wiring against moisture, corrosive atmospheres and excessive heat.
- Time should be allowed for lamps to stabilize in color when turned on for the first time. This may require several hours of operation, with more than one start. Lamp color is also subject to change under conditions of excess vibration or shock, and color appearance may vary between individual lamps.
- Lamps may require up to 10 minutes (4-8 minutes for CDM-R111) to re-light if there is a power interruption.
- Take care in handling and disposing of lamps. If an arc tube is broken, avoid skin contact with any of the contents or fragments.
- For proper installation and removal, lamp should be handled by the sides of the reflector and not by the aluminum front anti-glare cap.