

Installation Instructions

FM2D50 Series

Two Circuit Electronic

24 Hour or 7 Day

Time Switches



APPLICATION

Time based control of lighting, ventilating, heating, cooling or other electrical loads in commercial and industrial applications. The FM2D50 time switches are programmable for 24-hour or 7-day schedules as well as a "8th day" or holiday schedule.

The FM2D50 series is intended for either surface or Flush panel mounting. Din rail mounting is also available by ordering the accessory model #MB-DIN. The control is completely enclosed in a plastic housing and includes a terminal cover and sub-base for installation and hard wiring.

It is also supplied with a clear plastic snap-on dust cover.

TECHNICAL DATA

Output – SPDT relay with dry contacts

Switch Rating:

- 1/2 hp, 120V ac
- 1hp, 240V ac
- 16A, 277V ac resistive
- 12A Ballast, 120V ac
- 8A Ballast, 240V ac
- 720 VA 240V ac Pilot Duty
- 360 VA 120V ac Pilot duty
- 1000W Tungsten, 240V ac
- 600W Tungsten, 120V ac

3 year battery back-up

Supply voltages: Separate Models – 12VDC, 24VAC/DC, 120VAC, 208/240VAC, all 60Hz (refer to product label)

Shortest switch time: 1 minute

Ambient Temperature Range –20°F to 140°F (–28°C to 60°C)

AM/PM LCD display

Input Draw: 4VA

Screw terminal connections

1/4" quick connects

Accuracy ± 4 minutes per year

Agency Approvals: UL Recognized

Installation

To the installer:

1. Read operating instructions carefully.
2. Check the input and output ratings marked on the unit to make sure this product is suitable for your power supply and application.
3. Disconnect power supply prior to installation to prevent electrical shock.
4. Wire in accordance with National and Local electrical code requirements.

SURFACE MOUNTING

Remove cover, loosen two screws on opposite corners. Remove the housing that surrounds the time switch and the terminal cover away from the base. Remove timer module by pulling straight out.



Place screw through 3 mounting holes in base and screw to back panel or wall.

Wire in accordance with instructions. Replace terminal cover and push timer firmly onto base. Now replace housing and secure with screws.

PANEL MOUNTING

Cut a square hole 2-5/8" x 2-5/8" (66mm x 66mm) in the front of the panel. Insert the time switch through the opening. With a screwdriver, press down and turn out screws (A) until flanges are in position to fasten the unit in front panel, then release.

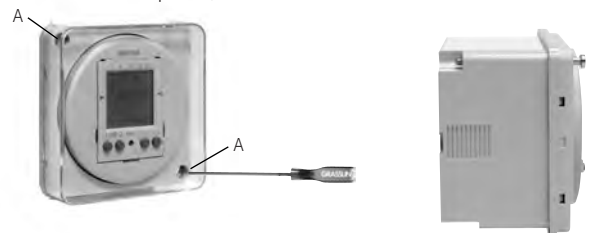

Use 1/4" quick connects and make connections in accordance with the wiring diagram shown and applicable code requirements.

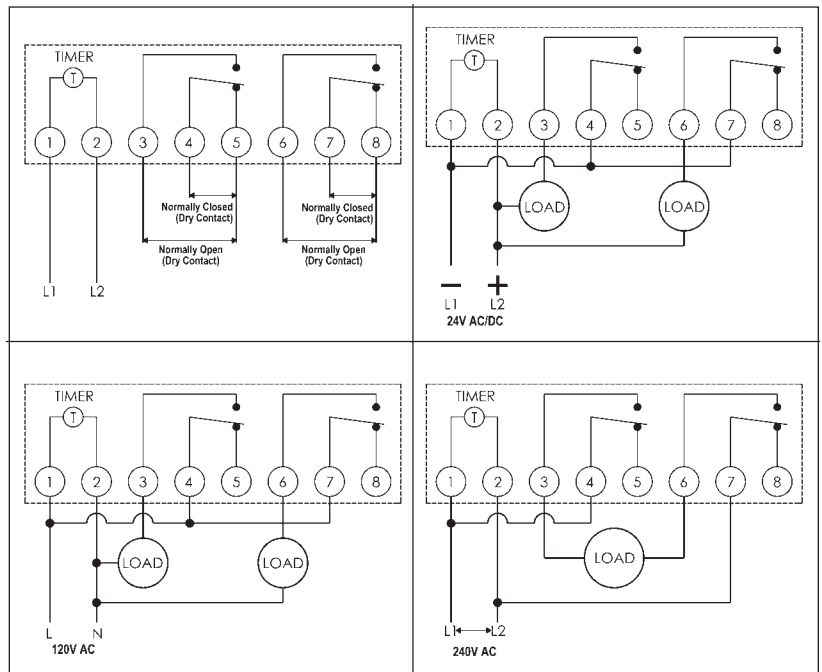

Program Schedules

Prog	CH1 ON/OFF	h	m	Day(s)	Holiday Program
Ex	On	7 am	30	Mon., Tue., Wed., Thurs, Fri.	No
1					
2					
3					
4					
5					
6					
7					
8					
9					
10					
11					
12					
13					
14					
15					
16					
17					
18					
19					
20					
21					
22					
23					
24					
25					
26					
27					
28					
29					
30					
31					
32					
33					
34					
35					
36					
37					
38					
39					
40					
41					
42					
43					
44					
45					
46					
47					
48					
49					
50					