

INSTRUCTION MANUAL

for OSCILLATING WALL FAN

- **WARNING:**

To reduce the risk of fire or electric shock, do not use this fan with any solid-state speed controller.

READ AND SAVE THIS INSTRUCTION MANUAL.

- **IMPORTANT INSTRUCTIONS:**

- Read all instructions before using this unit
- Always unplug unit before assembly, disassembly or cleaning
- Always unplug unit when not in use
- Do not use unit outdoors
- Do not insert foreign objects into guard
- Do not allow unit to become wet or damp
- Securely fasten front guard onto rear guard

SAVE THESE INSTRUCTIONS!

OPERATING INSTRUCTIONS

POWER CORD:

Plug the power cord into an outlet.

SPEED:

Speed is adjusted by pulling the string.

- OFF** turns off the unit
- LOW** provides low speed
- MED** provides medium speed
- HIGH** provides high speed

OSCILLATION:

To make the fan oscillate side-to-side, push down on the oscillating pin provided on the motor housing. To stop oscillation, pull up on pin.

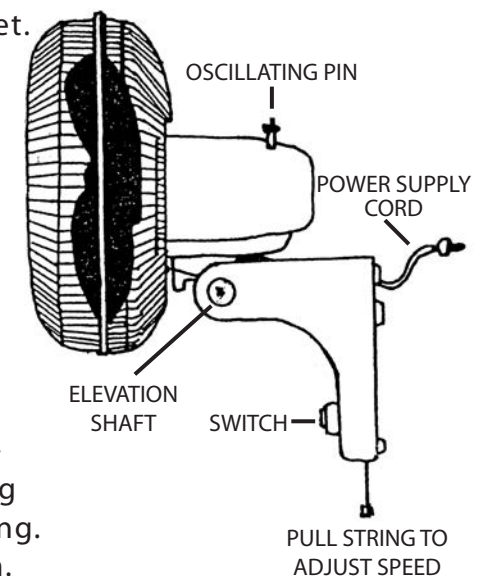

ASSEMBLY INSTRUCTIONS

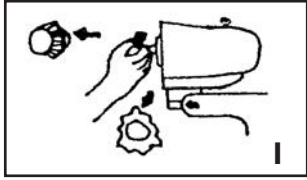

Step I: Unscrew Rear Guard Mounting Nut. ④

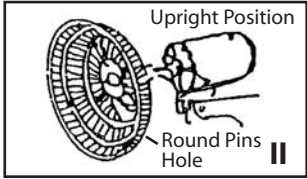

Step II: Mount the Rear Guard ⑤ to the motor ⑥ by matching the three holes on the Rear Guard to the three round pins on the Motor. Push in firmly until the three pins protrude through the three holes.

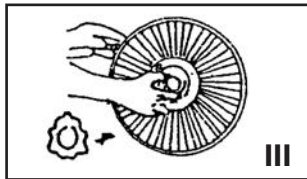

Step III: Tighten Rear Guard ⑤ with Rear Guard Mounting Nut ④ so that Rear Guard is snug against motor housing.

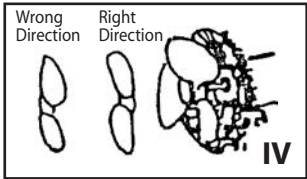

Step IV: Insert the Fan Blade ③ onto Motor shaft by matching hole shape in the Blade with shaft and tighten the Blade with Blade Cap ② by turning counterclockwise.

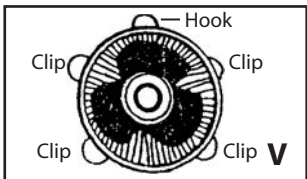

Step V: Mount Front Guard ① onto Rear Guard ⑤ by inserting hook of Front Guard over Rear Guard and secure with clips on Front Guard.

Step VI: Secure two screws (not provided) on wall 1-3/4" apart. Leave screws out approx. 1/2".

Step VII: To hang fan, place fan against wall (over screw heads) and slide down.

PARTS DIAGRAM

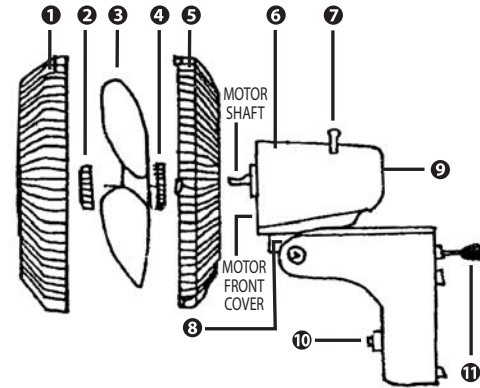

For shipping purposes, the fan is packed disassembled.

- ① Front Guard
- ② Blade Cap
- ③ Fan Blade
- ④ Rear Guard Mounting Nut
- ⑤ Rear Guard
- ⑥ Motor
- ⑦ Oscillating Pin
- ⑧ Swivel Joint
- ⑨ Rear Cover
- ⑩ Switch
- ⑪ Power Cord

MAINTENANCE INSTRUCTIONS

TO CLEAN:

Always unplug the fan before cleaning or disassembling. Be sure to use a soft cloth moistened with mild soap solution. Do not immerse Fan in water or allow water to drip into the fan housing. Avoid the use of gasoline, benzene, thinner etc. This will result in damage to the Fan.

Use a screwdriver to open the clip on the Front Guard frame. To disassemble each part, reverse the order assembly.

TO STORE:

Clean thoroughly and store in original box.