

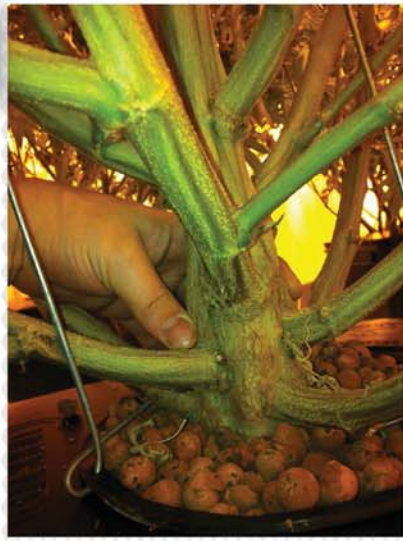

# CURRENT CULTURE H<sub>2</sub>O

CULTIVATING HYDROPONIC EVOLUTION™



## PRODUCTS 2013

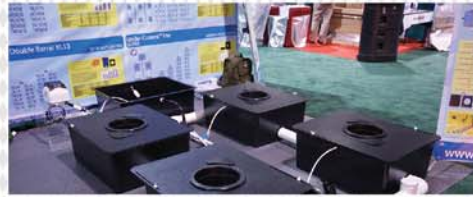



## Cultured Solutions™ Premium Plant Nutrients

Cultured Solutions™ was formulated specifically for high performance water culture applications such as our Under Current™, so as to maximize production and yields while minimizing the waste and excess often associated with hydroponics cultivation. Our well balanced, extremely concentrated mineral nutrient enables plants to thrive at relatively low concentrations, while maintaining unparalleled performance and quality. Though blended for water culture, Cultured Solutions™ is extremely compatible with other cultivation methods such as Coconut Pith/Coir and Rockwool.



## Under Current™ Features & Upgrades

We've recently added several new features that now come standard on the Under Current™ systems: CCH2O Lids, CCH2O Net Pot, UC Spin Tight Bulkheads and "Black Out" Series Growth Modules.

Designed and manufactured by Current Culture H2O™ right here in California, the CCH2O Lids, CCH2O Net Pot and UC Spin Tight Bulkhead represent our never ending quest to make the Under Current™ stronger, more efficient, more user friendly and more advanced than any other hydro system on the market.



## New website! CCH2O.com

Current Culture H2O is pleased to announce the debut of our brand new website. The new cch2o.com is packed full of product info, resources, photos, videos, grow room layouts and a handy dealer locator. With the launch of our revamped site it will now be easier for growers and retailers to get information and specs on all of our hydroponic systems, premium plant nutrients, parts and accessories.





## Premium Plant Nutrients

- 3 Cultured Solutions VEG A/B  
Cultured Solutions BLOOM A/B
- 4 Cultured Solutions UC ROOTS  
Cultured Solutions BUD BOOSTER

## Under Current System Information

- 5 Overview
- 6 Features & Upgrades
- 7 Sizing Guide
- 8 Lighting Guide

## Under Current Systems

- 9 **UC Series**  
Under Current
- 10 Under Current Evolution  
Under Current Double Barrel
- 11 **UCXL Series**  
Under Current XL
- 12 Under Current Evolution XL  
Under Current Double Barrel XL
- 13 **UCXL13 Series**  
Under Current XL13
- 14 Under Current Evolution XL13  
Under Current Double Barrel XL13
- 15 **UCXXL13 Series**  
Under Current XXL13

## Under Current Systems

- 16 Under Current Evolution XXL13  
Under Current Double Barrel XXL13
- 17 Under Current PRO

## Single Module Systems

- 17 UC Solo 8, 13 & PRO

## Under Current System Accessories

- 18 Lids, Bulkheads, Net Pot, Air Pumps,  
Module Cages, Hoodies & Parkas

## Hydro Accessories

- 19 Growth Modules, Air Diffusers, Float Valve Kits,  
Reservoir Adapter Kit, Drain Valve Kit
- 20 Professional Air Pumps, Mag-Drive Return Pumps,  
In-Line Filter, Uniseals, CCH2O Hose, Cool Coil

## Feeding Schedules

- 21 Usage Instructions &  
Feeding Charts

## General Recommendations

- 22 CCH2O General  
Recommendations

## Grow Room Layouts

- 23 Tent, Hut, Room & Commercial  
Layout Recommendations



# Cultured Solutions™ VEG A/B

Cultured Solutions Veg A & B is a full spectrum, mineral salt based nutrient which contains all the elements necessary to produce lush, vegetative growth. Cultured Solutions Veg combines all the macro and micro nutrients in their proper proportions, in a pH stable, chelated form which is ideal for high performance water culture applications. Cultured Solutions Veg provides the optimal Nitrate to Ammoniacal Nitrogen ratio. This ensures healthy growth without promoting brittle stalk and stem formation, or the unwanted pest outbreaks often associated with ammonium in excess. It's this attention to detail and quality control that sets Cultured Solutions Veg apart from other commercially available fertilizers.

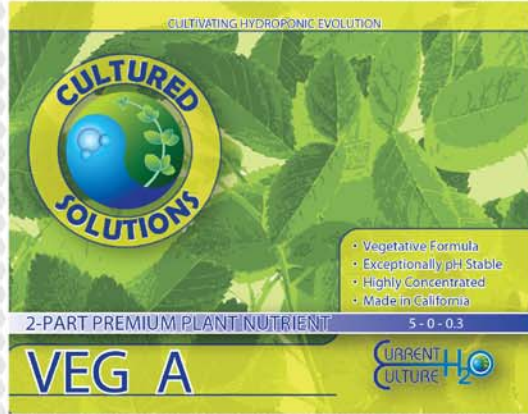

CULTURED SOLUTIONS - VEG - A/B	
CODE	DESCRIPTION
CSVEGAPT	CULTURED SOLUTIONS VEG A PT
CSVEGAQT	CULTURED SOLUTIONS VEG A QT
CSVEGAGAL	CULTURED SOLUTIONS VEG A GAL
CSVEGA2.5	CULTURED SOLUTIONS VEG A 2.5 GAL
CSVEGAS	CULTURED SOLUTIONS VEG A 5 GAL
CSVEGA15	CULTURED SOLUTIONS VEG A 15 GAL
CSVEGAS5	CULTURED SOLUTIONS VEG A 55 GAL
CSVEGBPT	CULTURED SOLUTIONS VEG B PT
CSVEGBQT	CULTURED SOLUTIONS VEG B QT
CSVEGBGAL	CULTURED SOLUTIONS VEG B GAL
CSVEGB2.5	CULTURED SOLUTIONS VEG B 2.5 GAL
CSVEGB5	CULTURED SOLUTIONS VEG B 5 GAL
CSVEGB15	CULTURED SOLUTIONS VEG B 15 GAL
CSVEGB55	CULTURED SOLUTIONS VEG B 55 GAL



# Cultured Solutions™ BLOOM A/B



Cultured Solutions Bloom A & B is a full spectrum, mineral salt based nutrient which contains all the elements necessary to produce prolific blooms and fruit. Cultured Solutions Bloom combines all the macro and micro nutrients in their proper proportions, in a pH stable, chelated form which is ideal for high performance water culture applications. Cultured Solutions Bloom provides the optimal Nitrate to Ammoniacal Nitrogen ratio. This ensures healthy growth without promoting excessive vegetal growth which can hinder and in many cases deter bud set and maturation in flowering plants.

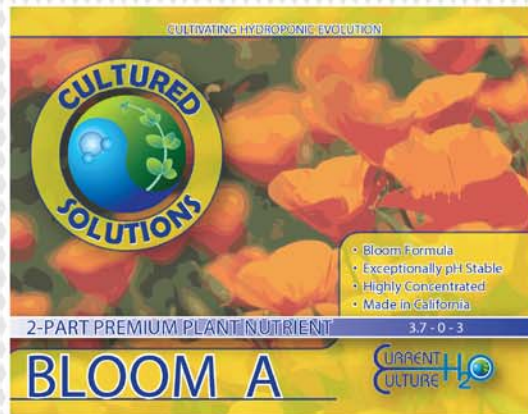

CULTURED SOLUTIONS - BLOOM - A/B	
CODE	DESCRIPTION
CSBLOOMAQT	CULTURED SOLUTIONS BLOOM A QT
CSBLOOMAGAL	CULTURED SOLUTIONS BLOOM A GAL
CSBLOOMA2.5	CULTURED SOLUTIONS BLOOM A 2.5 GAL
CSBLOOMA5	CULTURED SOLUTIONS BLOOM A 5 GAL
CSBLOOMA15	CULTURED SOLUTIONS BLOOM A 15 GAL
CSBLOOMA55	CULTURED SOLUTIONS BLOOM A 55 GAL
CSBLOOMBQT	CULTURED SOLUTIONS BLOOM B QT
CSBLOOMBGAL	CULTURED SOLUTIONS BLOOM B GAL
CSBLOOMB2.5	CULTURED SOLUTIONS BLOOM B 2.5 GAL
CSBLOOMB5	CULTURED SOLUTIONS BLOOM B 5 GAL
CSBLOOMB15	CULTURED SOLUTIONS BLOOM B 15 GAL
CSBLOOMB55	CULTURED SOLUTIONS BLOOM B 55 GAL





# Cultured Solutions™ UC ROOTS

Cultured Solutions UC Roots is a multi-purpose root zone optimizer that uses proprietary chemistry to aid in mineral descaling and removal of potentially harmful biofilms in nutrient reservoirs. By reducing the potential habitat for plant pathogens, UC Roots encourages a healthy, well balanced nutrient solution, perfect for explosive root growth!

UC Roots is formulated for optimum performance in water culture, but suitable for use in all cultivation styles and methods such as Coconut Pith and Coir, DTW, Rockwool, Ebb-Flow Tables, Aeroponics, etc. UC Roots can also be used as a nutrient leaching agent or for cleaning between cycles.

Cultured Solutions UC Roots is the most effective and simple to use root zone optimizer on the planet!

- Encourages Healthy Roots
- Liquid Crop Insurance
- Highly Concentrated
- Made in California

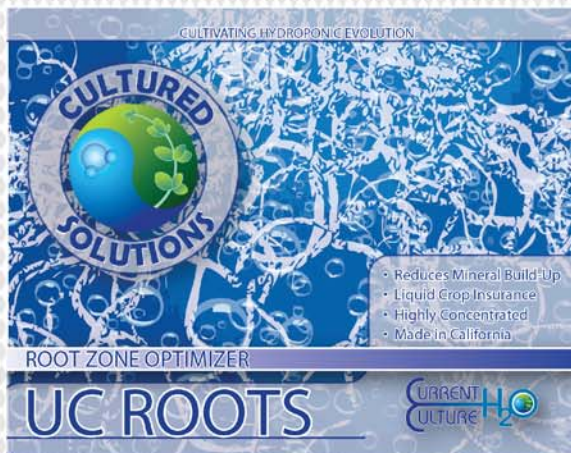

### CULTURED SOLUTIONS - UC ROOTS

CODE	DESCRIPTION
CSUCROOTSPT	UC ROOTS PT
CSUCROOTSQT	UC ROOTS QT
CSUCROOTSGAL	UC ROOTS GAL
CSUCROOTS2.5	UC ROOTS 2.5 GAL
CSUCROOTS5	UC ROOTS 5 GAL
CSUCROOTS15	UC ROOTS 15 GAL
CSUCROOTS55	UC ROOTS 55 GAL



Available in: Pint, Quart, Gallon, 2.5 Gallon, 5 Gallon, 15 Gallon, 55 Gallon and Bulk Sizes

# Cultured Solutions™ BUD BOOSTER



Cultured Solutions Bud Booster is a high potency fruit and flower stimulator, formulated to trigger and aid in the formation of prolific, fully developed reproductive growth in all flowering plant species. Cultured Solutions Bud Booster combines high levels of Phosphorous and Potassium in solution to provide your plants with the mineral precursors necessary during early and prime flower production periods. Our zero Nitrogen bloom booster also supplies mineral elements such as Sulfur and Magnesium to assist in the synthesis of essential amino acids and other naturally occurring plant compounds, crucial for optimum plant production and quality.

Cultured Solutions Bud Booster is not a PGR (Plant Growth Regulator), but rather a uniquely balanced blend of minerals. Our formula is perfectly suited for maximum plant uptake with no negative effects on fruit and flower quality or healthfulness. By providing your plants with the elemental minerals available in Cultured Solutions Bud Booster, you will unlock your plants inherent traits and encourage the production of complex sugars, starches and essential oils.

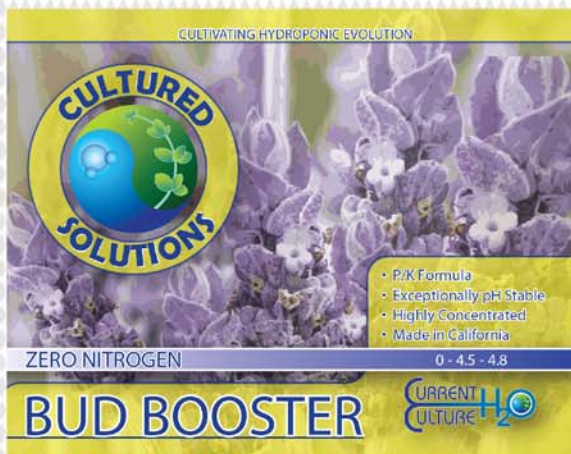

### CULTURED SOLUTIONS - BUDBOOSTER

CODE	DESCRIPTION
CSBUDBOOSTERQT	BUD BOOSTER QT.
CSBUDBOOSTERGAL	BUD BOOSTER GAL
CSBUDBOOSTER2.5	BUD BOOSTER 2.5 GAL
CSBUDBOOSTER5	BUD BOOSTER 5 GAL
CSBUDBOOSTER15	BUD BOOSTER 15 GAL
CSBUDBOOSTER55	BUD BOOSTER 55 GAL



Available in: Quart, Gallon, 2.5 Gallon, 5 Gallon, 15 Gallon, 55 Gallon and Bulk Sizes

# Under Current™ Overview

The Under Current™ utilizes **Sub-Current Culture™ (SCC)**, which employs **peripheral negative pressure** to recirculate highly oxygenated nutrient solution through the plants root zone. This perpetual fluid motion supercharges the nutrients with **dissolved oxygen**, creating a hyper aerobic condition, perfect for explosive plant growth. Our unique water culture application is unprecedented in both our layout versatility and ease of use. The Under Current™ consistently delivers awe-inspiring yields for **any sized application**.

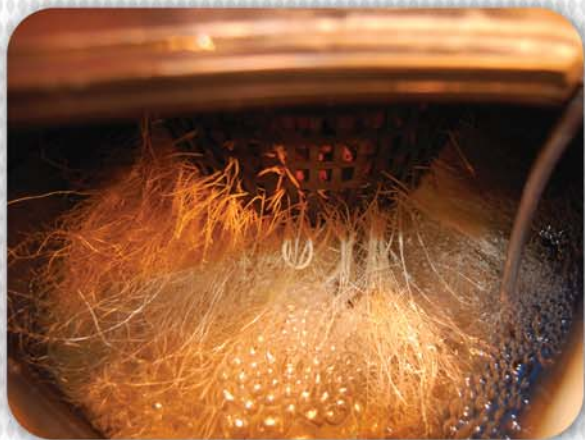

**Constant 24/7 Nutrient Circulation & Aeration**

**Increased Nutrient Efficiency**

**50+ System Configurations**

**Expandable Modular Design**

**Designed to Accommodate Any H.I.D. Lighting Layout**

**Larger Yields With Fewer Plants**

**Commercial Grade**

**Low Power Consumption**

**pH And EC/TDS Uniform Throughout Entire System**

**Conserves Water**



**Less Frequent Nutrient Change Outs**

**Easily Adaptable To Dosers, Top Off Reservoirs & Chillers**

**Includes Professional Quality Air & Water Pumps**

**Expert Grower Support**

**Hand Crafted in California**



# Under Current™ Features & Upgrades

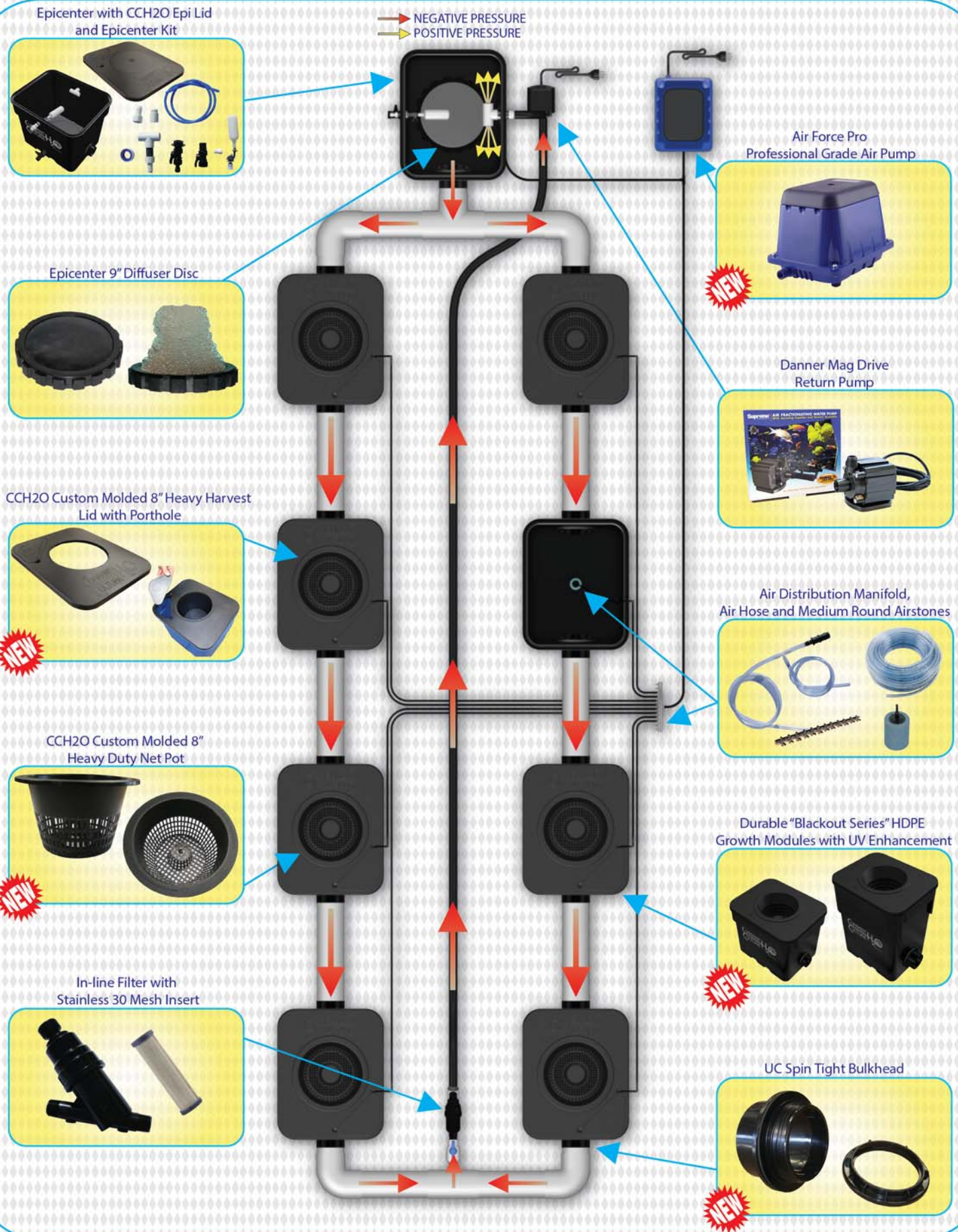

# Under Current Sizing Guide

## MODULE SIZE



## PLANT SPACING



\*\*All systems are available in a BONELESS configuration. BONELESS systems include PVC fittings (Elbows, Tees, etc.) and UC Spin Tight Bulkheads, but NO straight PVC. PVC would be provided and customized by the grower to suit their specific needs. All UC PRO systems come standard BONELESS.

## SYSTEM LAYOUT

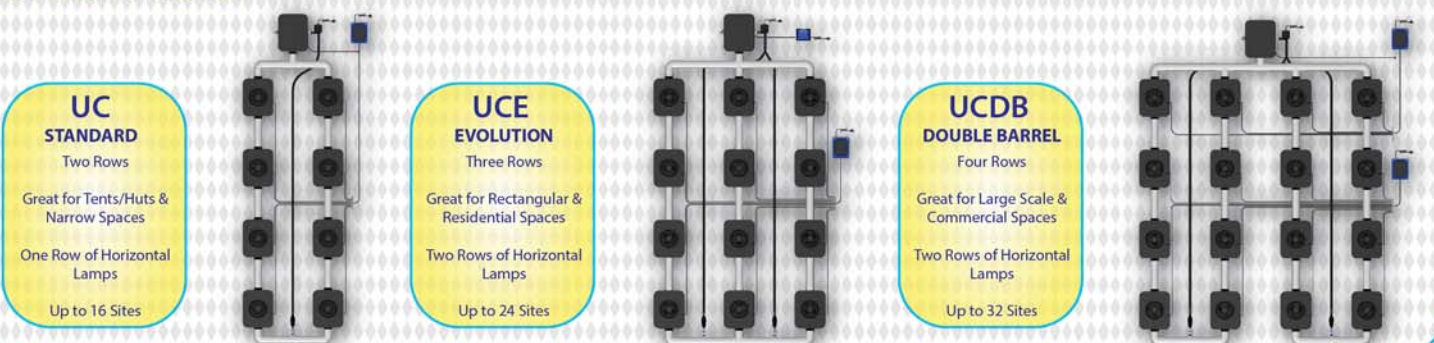

## PART NUMBER KEY

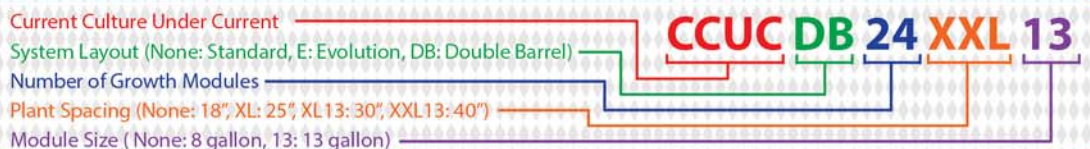



# Under Current™ Lighting Guide

## STANDARD

18" PLANT CENTERS



Systems on STANDARD - 18" plant centers require 1 x 600w horizontal lamp per every four GROWTH MODULES or 1 x 1000w horizontal lamp per every six or nine GROWTH MODULES. Recommended veg time is 1-2 weeks.

## XL

25" PLANT CENTERS



## XL13

30" PLANT CENTERS



Our most popular spacing. Systems on XL - 25" plant centers or XL13 - 30" plant centers require 1 x 1000w horizontal lamp per every four GROWTH MODULES. Recommended veg time is 2-3 weeks for XL systems and 3-5 weeks for XL13 systems.

## XXL13

40" PLANT CENTERS

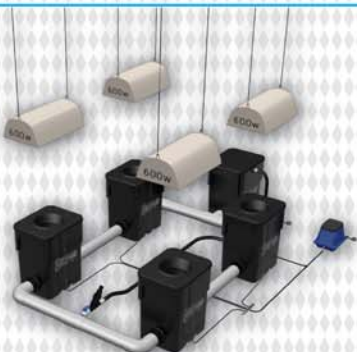

Systems on XXL13 - 40" plant centers require 1 x 600w horizontal lamp per every GROWTH MODULE or 600w vertical lamps between every set of four sites and around the outside between every two sites. Recommended veg time is 4-6 weeks.

## PRO (BONELESS)

VARIABLE PLANT CENTERS

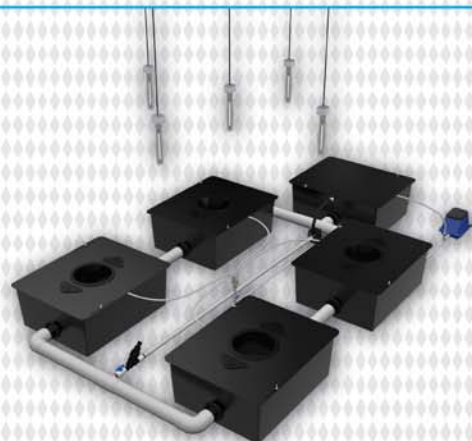
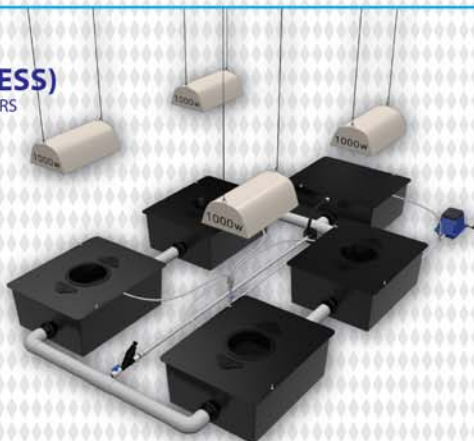

Systems on 50"+ plant centers require 1 x 1000w horizontal lamp per every GROWTH MODULE or 1000w vertical lamps between every set of four sites and around the outside between every two sites. Recommended veg time is 6-8 weeks.

# UC Series

- Great Veg System for Larger Configurations
- Multiple Lid Configurations Available
- Great for Tents & Huts
- Recommended Veg Growth Time: 1-2 Weeks
- 8 Gallon Growth Modules
- 2" UC Spin Tight Bulkheads
- 18" Plant Centers



### The Under Current™ Original Includes:

8 gallon "Blackout Series" growth modules, 2" manifolds, 2" UC Spin Tight Bulkheads, CCH2O 8" custom molded Lids with Port Hole, CCH2O 8" custom molded Net Pots, Danner Mag-Drive™ Return Pump, Air Force Pro™ Air Pump, 9" Air Diffuser Disc, Medium Round Air Stones, Air Distribution Manifold, Air Hose, In-Line Filter, Adjustable Float Valve with Reservoir Adapter Kit, Drain Valve, Chiller Adapter, Garden Hose Drain Adapter, Cultured Solutions™ VEG A/B and 1-Year Warranty.

# Under Current™

18" PLANT CENTERS

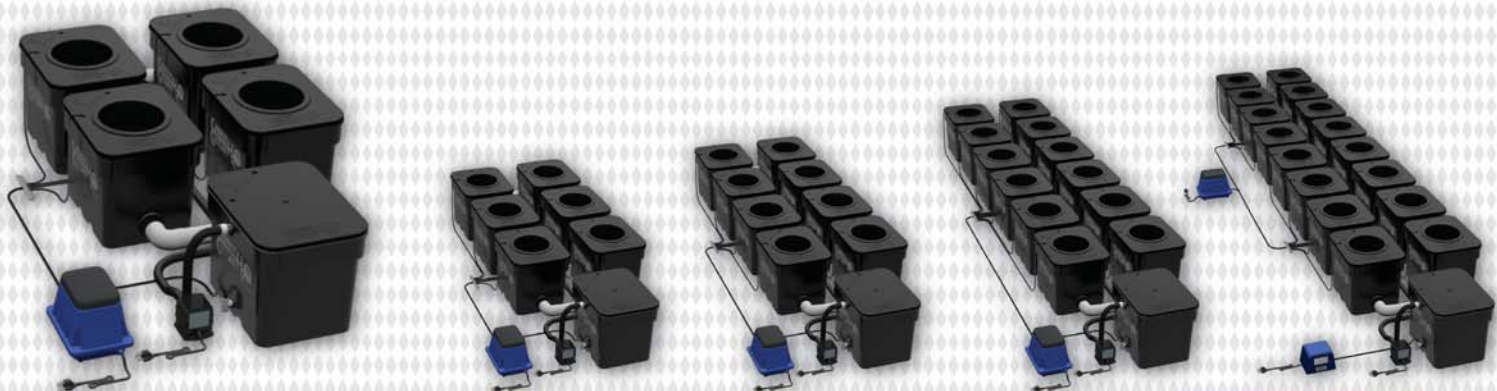

UNDER CURRENT	UC4	UC6	UC8	UC12	UC16
SIZE (INCHES)	32 x 59	32 x 77	32 x 96	32 x 133	32 x 170
FULL SYSTEM VOLUME (GALLONS)	35	45	65	90	120
POWER USAGE (WATTS)	64	75	145	160	213
AIR PUMP(S)	AFP-40	AFP-40	AFP-60	AFP-80	(1)AFP-15, (1)AFP-80
WATER PUMP(S)	MAG250	MAG350	MAG500	MAG700	MAG950
RECIRCULATION TURNOVER RATE PER HR.	7.20	7.70	7.60	7.70	7.90
RECOMMENDED LIGHTING	1 X 600W	1 X 1000W	2 X 600W	2 X 1000W	4 X 600W
RECOMMENDED CHILLER*	1/10 - 1/6 HP	1/10 - 1/6 HP	1/10 - 1/6 HP	1/4 - 1/2 HP	1/4 - 1/2 HP
RECOMMENDED RESERVOIR (GALLONS)	40	50	70	100	125
SHIPPING WEIGHT (LBS.)	40	50	60	90	105
SHIPPING BOX SIZES	(1)16X16X36	(2)16X16X28	(1)16X16X36, (1)16X16X28	(1)16X16X36, (2)16X16X28	(2)16X16X36, (1)16X18X48

\* General Recommendation - Check Manufacturers Specifications for proper chiller sizing.

# Under Current™ Evolution

18" PLANT CENTERS

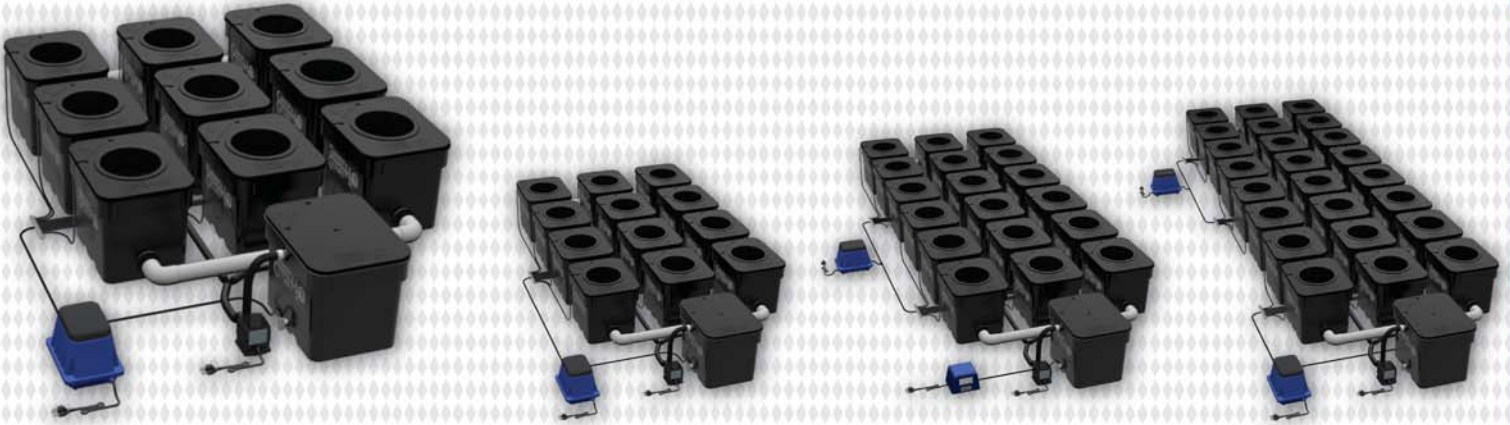

UNDER CURRENT EVOLUTION	UCE9	UCE12	UCE18	UCE24
SIZE (INCHES)	50 x 77	50 x 96	50 x 133	50 x 170
FULL SYSTEM VOLUME (GALLONS)	70	90	130	170
POWER USAGE (WATTS)	105	160	185	270
AIR PUMP(S)	AFP-60	AFP-80	(1) AFP-15 (1) AFP-80	(1) AFP-60, (1) AFP-80
WATER PUMP(S)	MAG500	MAG700	MAG950	MAG1200
RECIRCULATION TURNOVER RATE PER HR.	7.10	7.70	7.30	7.00
RECOMMENDED LIGHTING	1 X 1000W	2 X 1000W	3 X 1000W	4 X 1000W
RECOMMENDED CHILLER*	1/10 - 1/6 HP	1/4 - 1/2 HP	1/2 HP	1 HP
RECOMMENDED RESERVOIR (GALLONS)	75	100	140	175
SHIPPING WEIGHT (LBS.)	90	110	140	200
SHIPPING BOX SIZES	(1) 16X18X48, (2) 16X16X36	(2) 16X18X48, (1) 16X16X28	(3) 16X18X48, (1) 16X16X36	(4) 16X18X48, (1) 16X16X28

\* General Recommendation - Check Manufacturers Specifications for proper chiller sizing.

# Under Current™ Double Barrel

18" PLANT CENTERS

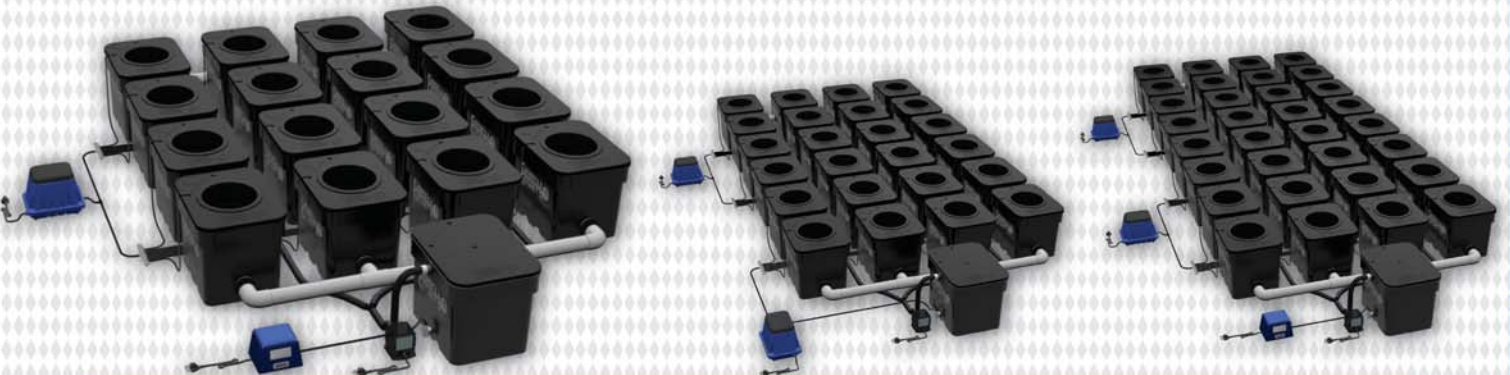

UNDER CURRENT DOUBLE BARREL	UCDB16	UCDB24	UCDB32
SIZE (INCHES)	90 x 96	90 x 133	90 x 170
FULL SYSTEM VOLUME (GALLONS)	120	170	230
POWER USAGE (WATTS)	213	245	320
AIR PUMP(S)	(1)AFP-15, (1)AFP-80	(1) AFP-60, (1) AFP-80	(1)AFP-15 (2) AFP-80
WATER PUMP(S)	MAG950	MAG1200	MAG1800
RECIRCULATION TURNOVER RATE PER HR.	7.90	7.00	7.80
RECOMMENDED LIGHTING	4 X 600W	6 X 600W OR 4 X 1000W	8 X 600W OR 6 X 1000W
RECOMMENDED CHILLER*	1/4 - 1/2 HP	1/2 - 1 HP	1 - 1.5 HP
RECOMMENDED RESERVOIR (GALLONS)	125	175	250
SHIPPING WEIGHT (LBS.)	105	140	175
SHIPPING BOX SIZES	(3)16X16X36	(3)16x18x48 (1)16x16x28	(4)16x18x48 (1)16x16x28

\* General Recommendation - Check Manufacturers Specifications for proper chiller sizing.

# UCXL Series

- Our Most Popular Spacing Configuration
- Larger Yields with Fewer Plants
- Four Plants per Light
- Recommended Veg Growth Time: 2-3 Weeks
- 8 Gallon Growth Modules
- 2" UC Spin Tight Bulkheads
- 25" Plant Centers



## The Under Current™ XL Includes:

8 gallon "Blackout Series" growth modules, 2" manifolds, 2" UC Spin Tight Bulkheads, CCH2O 8" custom molded Lids with Port Hole, CCH2O 8" custom molded Net Pots, Danner Mag-Drive™ Return Pump, Air Force Pro™ Air Pump, 9" Air Diffuser Disc, Medium Round Air Stones, Air Distribution Manifold, Air Hose, In-Line Filter, Adjustable Float Valve with Reservoir Adapter Kit, Drain Valve, Chiller Adapter, Garden Hose Drain Adapter, Cultured Solutions™ VEG A/B and 1-Year Warranty.

# Under Current™ XL

25" PLANT CENTERS

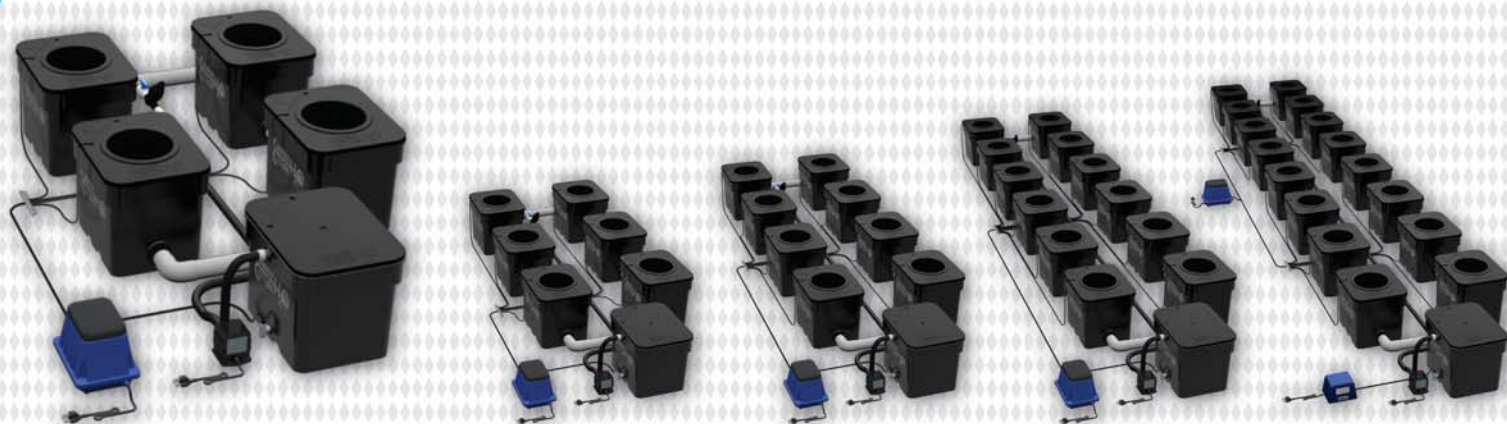

UNDER CURRENT XL	UC4XL	UC6XL	UC8XL	UC12XL	UC16XL
SIZE (INCHES)	39 x 65	39 x 91	39 x 115	39 x 165	39 x 215
FULL SYSTEM VOLUME (GALLONS)	35	50	65	90	120
POWER USAGE (WATTS)	64	75	145	160	213
AIR PUMP(S)	AFP-40	AFP-40	AFP-60	AFP-80	(1)AFP-15, (1)AFP-80
WATER PUMP(S)	MAG250	MAG350	MAG500	MAG700	MAG950
RECIRCULATION TURNOVER RATE PER HR.	7.20	7.70	7.60	7.70	7.90
RECOMMENDED LIGHTING	1 X 1000W	2 X 600W	2 X 1000W	3 X 1000W	4 X 1000W
RECOMMENDED CHILLER*	1/10 - 1/6 HP	1/10 - 1/6 HP	1/10 - 1/6 HP	1/4 - 1/2 HP	1/4 - 1/2 HP
RECOMMENDED RESERVOIR (GALLONS)	40	50	70	100	125
SHIPPING WEIGHT (LBS.)	40	60	80	105	120
SHIPPING BOX SIZES	(1)16X16X36	(2)16x16x28	(1)16X16X36, (1)16X16X28	(1)16X16X36, (2)16X16X28	(1)16X18X48 (2)16X16X36

\* General Recommendation - Check Manufacturers Specifications for proper chiller sizing.

# Under Current™ Evolution XL

25" PLANT CENTERS

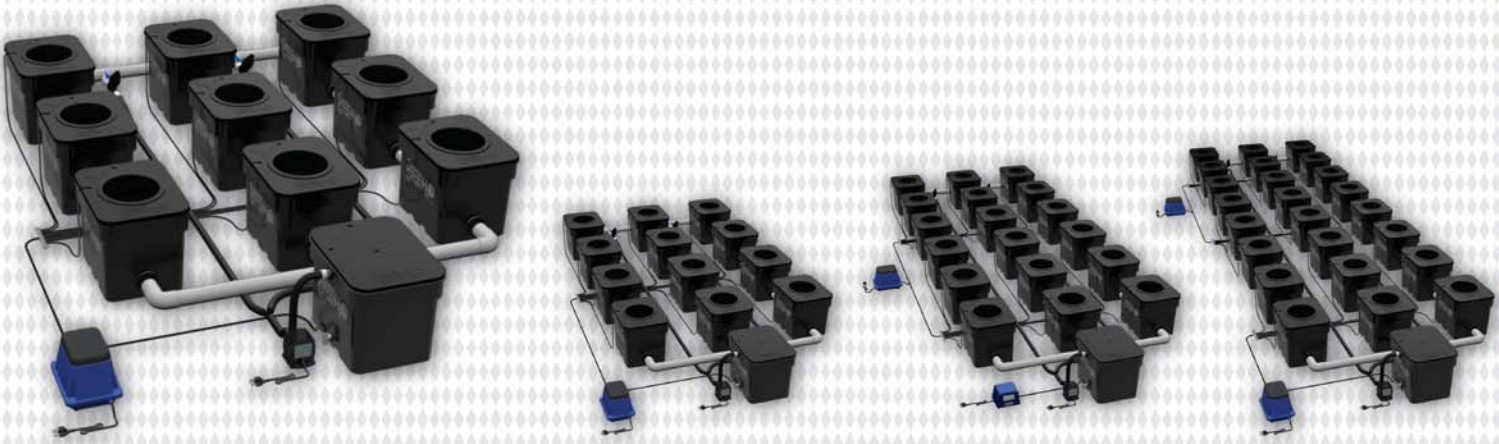

UNDER CURRENT EVOLUTION XL	UCE9XL	UCE12XL	UCE18XL	UCE24XL
SIZE (INCHES)	64 x 91	64 x 115	64 x 165	64 x 215
FULL SYSTEM VOLUME (GALLONS)	70	90	130	170
POWER USAGE (WATTS)	105	160	185	270
AIR PUMP(S)	AFP-60	AFP-80	(1) AFP-15 (1) AFP-80	(1) AFP-60, (1) AFP-80
WATER PUMP(S)	MAG500	MAG700	MAG950	MAG1200
RECIRCULATION TURNOVER RATE PER HR.	7.10	7.70	7.30	7.00
RECOMMENDED LIGHTING	4 X 600W	6 X 600W	8 X 600W	10 X 600W
RECOMMENDED CHILLER*	1/10 - 1/6 HP	1/4 - 1/2 HP	1/2 HP	1 HP
RECOMMENDED RESERVOIR (GALLONS)	75	100	140	175
SHIPPING WEIGHT (LBS.)	90	110	140	200
SHIPPING BOX SIZES	(1) 16X18X48, (2) 16X16X36	(2) 16X18X48, (1) 16X16X28	(3) 16X18X48, (1) 16X16X36	(4) 16X18X48, (1) 16X16X28

\* General Recommendation - Check Manufacturers Specifications for proper chiller sizing.

# Under Current™ Double Barrel XL

25" PLANT CENTERS

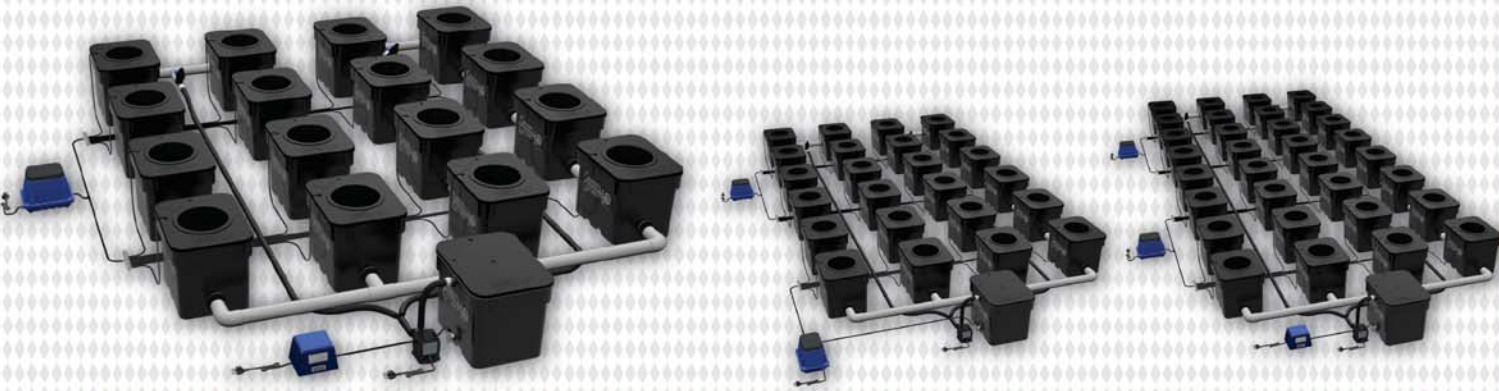

UNDER CURRENT DOUBLE BARREL XL	UCDB16XL	UCDB24XL	UCDB32XL
SIZE (INCHES)	98 x 115	98 x 165	98 x 215
FULL SYSTEM VOLUME (GALLONS)	120	170	230
POWER USAGE (WATTS)	213	245	320
AIR PUMP(S)	(1)AFP-15, (1)AFP-80	(1) AFP-60, (1) AFP-80	(1)AFP-15 (2) AFP-80
WATER PUMP(S)	MAG950	MAG1200	MAG1800
RECIRCULATION TURNOVER RATE PER HR.	7.90	7.00	7.80
RECOMMENDED LIGHTING	4 X 1000W	6 X 1000W	8 X 1000W
RECOMMENDED CHILLER*	1/4 - 1/2 HP	1/2 - 1 HP	1 - 1.5 HP
RECOMMENDED RESERVOIR (GALLONS)	125	175	250
SHIPPING WEIGHT (LBS.)	105	140	175
SHIPPING BOX SIZES	(2) 16X16X36, (1) 16X18X48	(3) 16X18X48 (1) 16X16X28	(4) 16X18X48 (1) 16X16X36

\* General Recommendation - Check Manufacturers Specifications for proper chiller sizing.

# UCXL13 Series

- Our Most Popular Spacing Configuration Supersized
- 60% Larger Than 8 Gallon Systems
- Larger 3" Circulation Manifolds
- Recommended Veg Growth Time: 3-5 Weeks
- 13 Gallon Growth Modules
- 3" UC Spin Tight Bulkheads
- 30" Plant Centers

**13**  
GALLON  
3" BULKHEAD



← 30" →



## The Under Current™ XL13 Includes:

13 gallon "Blackout Series" growth modules, 3" manifolds, 3" UC Spin Tight Bulkheads, CCH2O 8" custom molded Lids with Port Hole, CCH2O 8" custom molded Net Pots, Danner Mag-Drive™ Return Pump, Air Force Pro™ Air Pump, 9" Air Diffuser Disc, Medium Round Air Stones, Air Distribution Manifold, Air Hose, In-Line Filter, Adjustable Float Valve with Reservoir Adapter Kit, Drain Valve, Chiller Adapter, Garden Hose Drain Adapter, Cultured Solutions™ VEG A/B and 1-Year Warranty.

# Under Current™ XL13

**30"** PLANT CENTERS

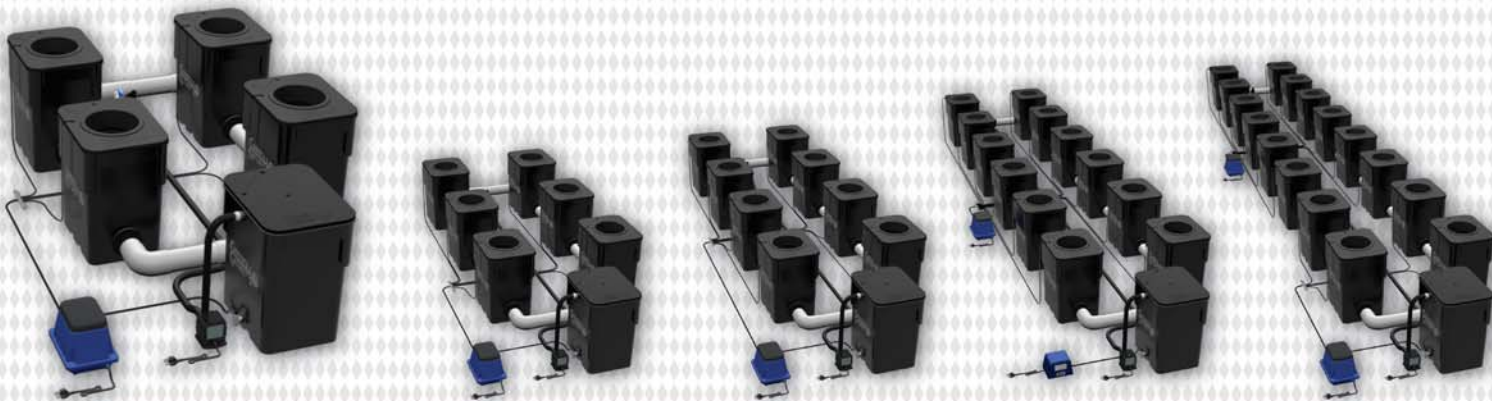

UNDER CURRENT XL13	UC4XL13	UC6XL13	UC8XL13	UC12XL13	UC16XL13
SIZE (INCHES)	44 x 83	44 x 114	44 x 145	44 x 207	44 x 269
FULL SYSTEM VOLUME (GALLONS)	55	80	100	145	190
POWER USAGE (WATTS)	75	145	160	213	250
AIR PUMP(S)	AFP-40	AFP-60	AFP-80	(1)AFP-15, (1)AFP-80	(1)AFP-40, (1)AFP-80
WATER PUMP(S)	MAG350	MAG500	MAG700	MAG950	MAG1200
RECIRCULATION TURNOVER RATE PER HR.	6.30	6.20	7.00	6.50	6.30
RECOMMENDED LIGHTING	1 X 1000W	2 X 600W	2 X 1000W	3 X 1000W	4 X 1000W
RECOMMENDED CHILLER*	1/10 - 1/6 HP	1/4 - 1/2 HP	1/4 - 1/2 HP	1/4 - 1/2 HP	1/2 - 1 HP
RECOMMENDED RESERVOIR (GALLONS)	60	85	110	150	200
SHIPPING WEIGHT (LBS.)	50	55	60	90	120
SHIPPING BOX SIZES	(1)16X18X48, (1)16x16x36	(2)16x18x48	(2)16x18x48	(3)16X18X48	(4)16X18X48

\* General Recommendation - Check Manufacturers Specifications for proper chiller sizing.

# Under Current™ Evolution XL13

30" PLANT CENTERS

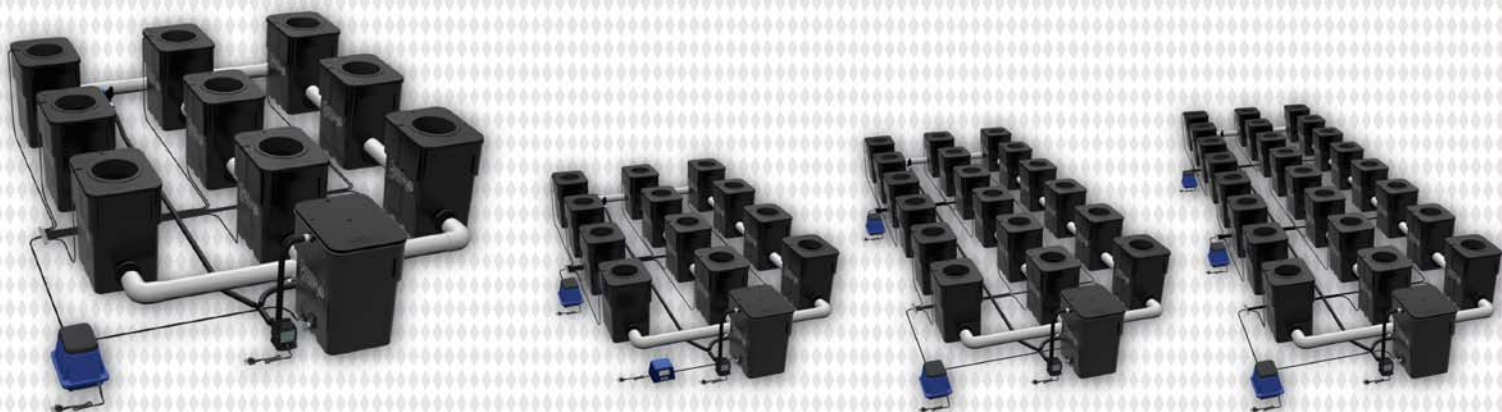

UNDER CURRENT EVOLUTION XL13	UCE9XL13	UCE12XL13	UCE18XL13	UCE24XL13
SIZE (INCHES)	74 x 114	74 x 145	74 x 207	74 x 269
FULL SYSTEM VOLUME (GALLONS)	110	145	205	275
POWER USAGE (WATTS)	160	213	250	365
AIR PUMP(S)	AFF-80	(1)AFF-15, (1)AFF-80	(1)AFF-60, (1)AFF-80	(1)AFF-60, (2)AFF-80
WATER PUMP(S)	MAG700	MAG950	MAG1200	MAG1800
RECIRCULATION TURNOVER RATE PER HR.	6.40	6.50	5.80	6.50
RECOMMENDED LIGHTING	4 X 600W	6 X 600W OR 4 X 1000W	8 X 600W OR 6 X 1000W	10 X 600W OR 8 X 1000W
RECOMMENDED CHILLER*	1/4 - 1/2 HP	1/4 - 1/2 HP	1/2 - 1 HP	1/2 - 1 HP
RECOMMENDED RESERVOIR (GALLONS)	120	150	215	285
SHIPPING WEIGHT (LBS.)	75	100	150	180
SHIPPING BOX SIZES	(2)16x18x48, (1)16x16x56	(1)16x16x36, (2)16x18x48, (1)16x16x56	(4)16x18x48, (1)16x16x56	(5)16x18x48, (1)16x16x56

\* General Recommendation - Check Manufacturers Specifications for proper chiller sizing.

# Under Current™ Double Barrel XL13

30" PLANT CENTERS

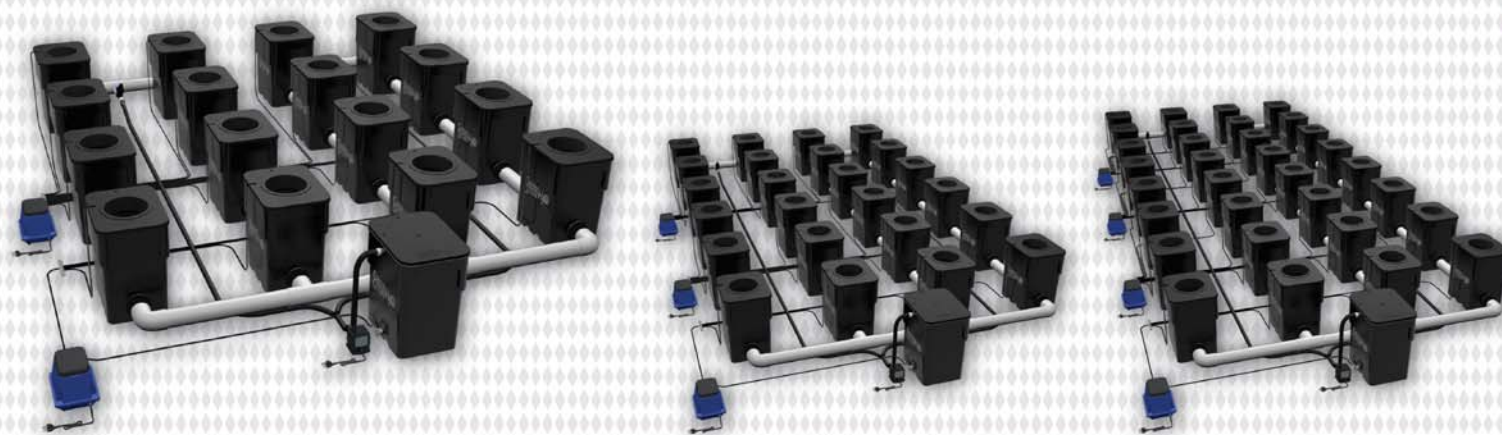

UNDER CURRENT DOUBLE BARREL XL13	UCDB16LXL13	UCDB24XL13	UCDB32XL13
SIZE (INCHES)	106 x 145	106 x 207	106 x 269
FULL SYSTEM VOLUME (GALLONS)	190	275	365
POWER USAGE (WATTS)	250	365	520
AIR PUMP(S)	(1)AFP-40, (1)AFP-80	(1)AFP-60, (2)AFP-80	(1) AFP-40, (3) AFP-80
WATER PUMP(S)	MAG1200	MAG1800	MAG2400
RECIRCULATION TURNOVER RATE PER HR.	6.30	6.50	6.50
RECOMMENDED LIGHTING	4 X 1000W	6 X 1000W	8 X 1000
RECOMMENDED CHILLER*	1/2 - 1 HP	1 - 1.5 HP	1.5 - 2 HP
RECOMMENDED RESERVOIR (GALLONS)	200	285	375
SHIPPING WEIGHT (LBS.)	130	200	280
SHIPPING BOX SIZES	(4)16x18x48	(5)16x18x48, (1)16x18x36	(7)16x18x48

\* General Recommendation - Check Manufacturers Specifications for proper chiller sizing.

# UCXXL13 Series

- Large Plant Spacing for Growing Trees
- Specifically Designed for Vertical Lighting
- Great for Large Scale Commercial Growers
- Recommended Veg Growth Time: 4-6 Weeks
- 13 Gallon Growth Modules
- 3" UC Spin Tight Bulkheads
- 40" Plant Centers

**13**  
GALLON  
3" BULKHEAD

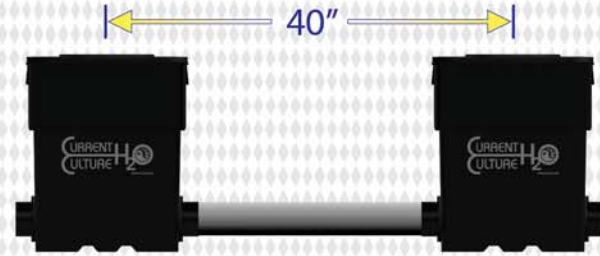

## The Under Current™ XXL13 Includes:

13 gallon "Blackout Series" growth modules, 3" manifolds, 3" UC Spin Tight Bulkheads, CCH2O 8" custom molded Lids with Port Hole, CCH2O 8" custom molded Net Pots, Danner Mag-Drive™ Return Pump, Air Force Pro™ Air Pump, 9" Air Diffuser Disc, Medium Round Air Stones, Air Distribution Manifold, Air Hose, In-Line Filter, Adjustable Float Valve with Reservoir Adapter Kit, Drain Valve, Chiller Adapter, Garden Hose Drain Adapter, Cultured Solutions™ VEG A/B and 1-Year Warranty.

# Under Current™ XXL13

**40"** PLANT CENTERS

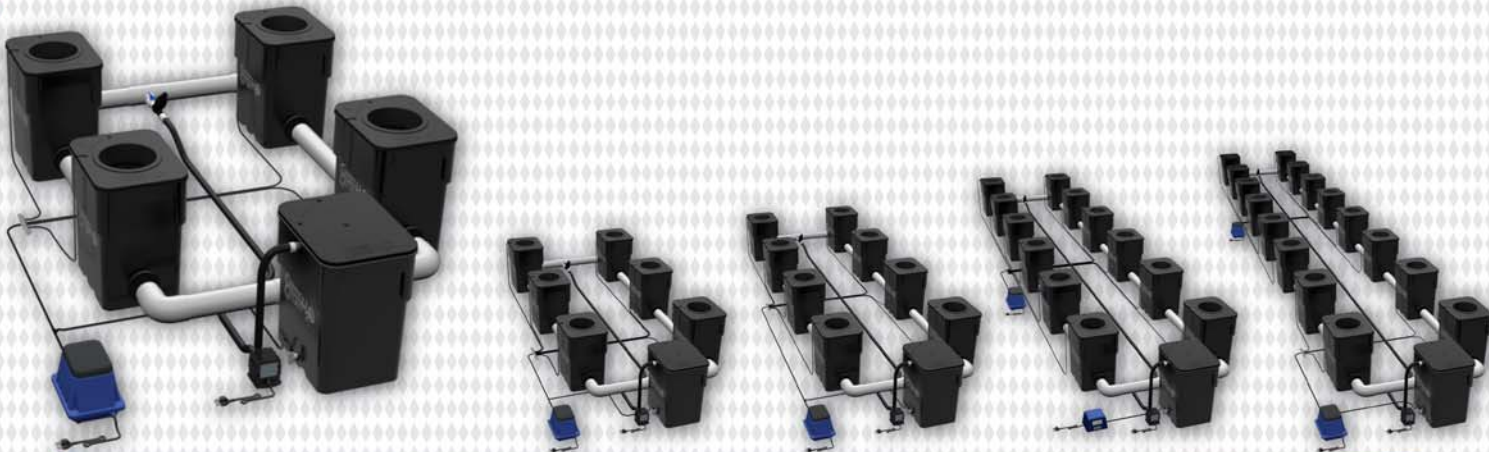

UNDER CURRENT XXL13	UC4XXL13	UC6XXL13	UC8XXL13	UC12XXL13	UC16XXL13
SIZE (INCHES)	54 x 84	54 x 125	54 x 168	54 x 252	54 x 336
FULL SYSTEM VOLUME (GALLONS)	55	80	100	145	190
POWER USAGE (WATTS)	75	145	160	213	250
AIR PUMP(S)	AFP-40	AFP-60	AFP-80	(1)AFP-15, (1)AFP-80	(1)AFP-40, (1)AFP-80
WATER PUMP(S)	MAG350	MAG500	MAG700	MAG950	MAG1200
RECIRCULATION TURNOVER RATE PER HR.	6.3	6.2	7	6.5	6.3
RECOMMENDED LIGHTING (VERTICAL)	5 X 600W	8 X 600W	11 X 600W	17 X 600W	23 X 600W
RECOMMENDED CHILLER*	1/10 - 1/6 HP	1/4 - 1/2 HP	1/4 - 1/2 HP	1/4 - 1/2 HP	1/2 - 1 HP
RECOMMENDED RESERVOIR (GALLONS)	60	85	110	150	200
SHIPPING WEIGHT (LBS.)	50	60	80	90	120
SHIPPING BOX SIZES	(2)16x18x48	(2)16x18x48	(3)16x18x48	(3)16x18x48	(4)16x18x48

\* General Recommendation - Check Manufacturers Specifications for proper chiller sizing.



# Under Current™ Evolution XXL13

40" PLANT CENTERS

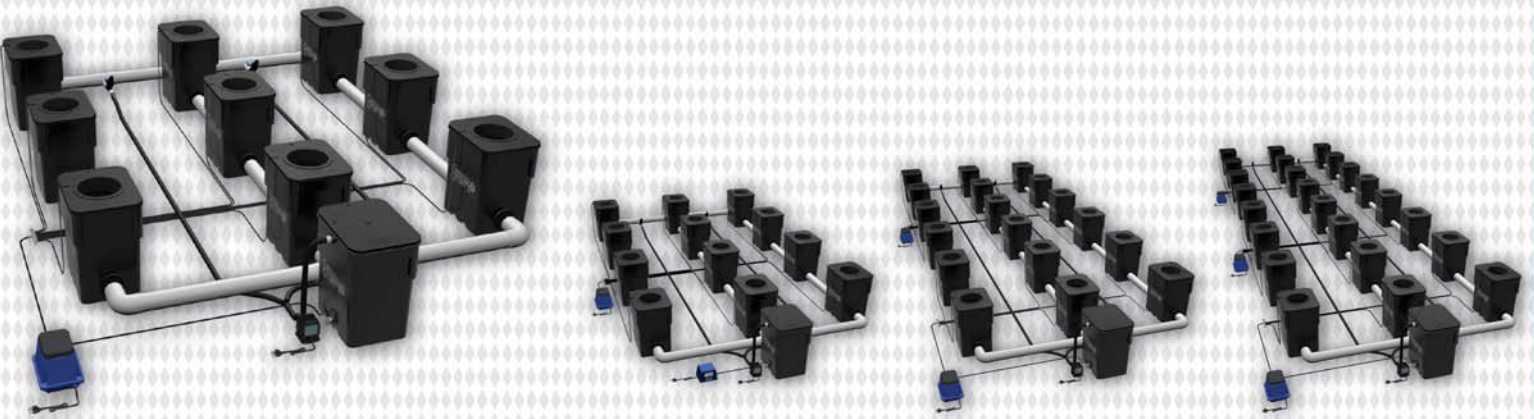

UNDER CURRENT EVOLUTION XXL13	UCE9XXL13	UCE12XXL13	UCE18XXL13	UCE24XXL13
SIZE (INCHES)	94 x 125	94 x 168	94 x 252	94 x 336
FULL SYSTEM VOLUME (GALLONS)	110	145	205	275
POWER USAGE (WATTS)	160	213	250	365
AIR PUMP(S)	AFP-80	(1)AFP-15,(1)AFP-80	(1)AFP-60,(1)AFP-80	(1)AFP-60,(2)AFP-80
WATER PUMP(S)	MAG700	MAG950	MAG1200	MAG1800
RECIRCULATION TURNOVER RATE PER HR.	6.40	6.50	5.80	6.50
RECOMMENDED LIGHTING VERTICAL	12 X 600W	16 X 600W	24 X 600W	32 X 600W
RECOMMENDED CHILLER*	1/4 - 1/2 HP	1/4 - 1/2 HP	1/2 - 1 HP	1/2 - 1 HP
RECOMMENDED RESERVOIR (GALLONS)	120	150	215	285
SHIPPING WEIGHT (LBS.)	90	120	170	240
SHIPPING BOX SIZES	(3)16X18X48	(3)16X18X48, (1) 16X16X36	(5)16X18X48	(6)16X18X48

\* General Recommendation - Check Manufacturers Specifications for proper chiller sizing.

# Under Current™ Double Barrel XXL13

40" PLANT CENTERS

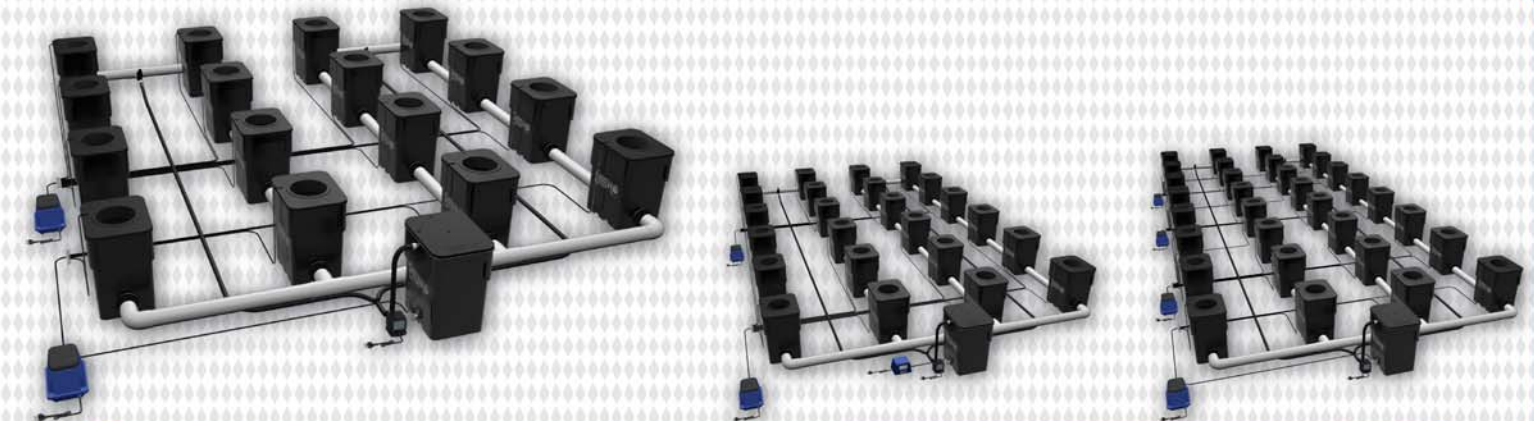

UNDER CURRENT DOUBLE BARREL XXL13	UCDB16LXXL13	UCDB24XXL13	UCDB32XXL13
SIZE (INCHES)	133 x 168	133 x 252	133 x 336
FULL SYSTEM VOLUME (GALLONS)	200	290	385
POWER USAGE (WATTS)	250	365	520
AIR PUMP(S)	(1)AFP-40,(1)AFP-80	(1)AFP-60,(2)AFP-80	(1) AFP-40,(3) AFP-80
WATER PUMP(S)	MAG1200	MAG1800	MAG2400
RECIRCULATION TURNOVER RATE PER HR.	6.30	6.50	6.50
RECOMMENDED LIGHTING	21 X 600W	31 X 600W	41 X 600W
RECOMMENDED CHILLER*	1/2 - 1 HP	1 - 1.5 HP	1.5 - 2 HP
RECOMMENDED RESERVOIR (GALLONS)	200	300	400
SHIPPING WEIGHT (LBS.)	150	220	300
SHIPPING BOX SIZES	(5)16X18X48	(7)16X18X48	(8)16X18X48

\* General Recommendation - Check Manufacturers Specifications for proper chiller sizing.

# Under Current™ PRO

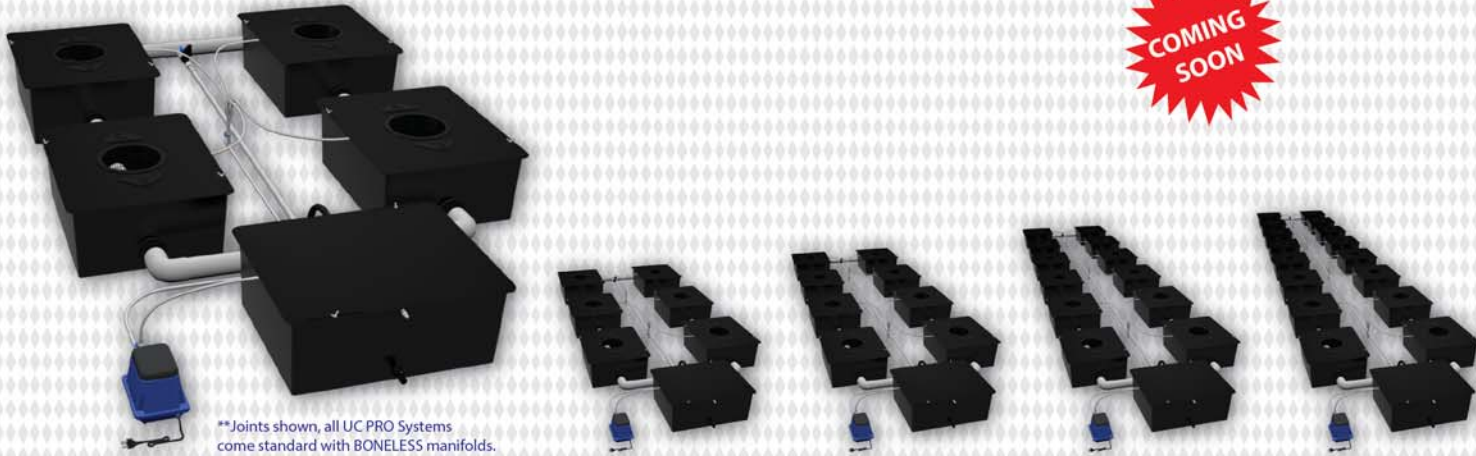

\*\*Joints shown, all UC PRO Systems come standard with BONELESS manifolds.

- Built for Professional Commercial Growers
- 35 Gallon Greenhouse Grade ABS Growth Modules with 3" UC Spin Tight Bulkheads
- Heavy Duty ABS Lid with (2) Portholes & 10" Net Pot
- Professional Grade Quick Connect Air Manifold with CCH2O Premium Air Diffusers
- Recommended Veg Growth Time: 6-8 Weeks

UNDER CURRENT PRO	UCPRO4	UCPRO6	UCPRO8	UCPRO12	UCPRO16
SIZE (INCHES)	Variable	Variable	Variable	Variable	Variable
FULL SYSTEM VOLUME (GALLONS)	140	200	255	365	475
POWER USAGE (WATTS)	180	253	371	466	769
AIR PUMP(S)	AL-100	AL-150	AL-200	AFP-60, AL-200	AL-400
WATER PUMP(S)	MAG700	MAG950	MAG1200	MAG1800	MAG2400
RECIRCULATION TURNOVER RATE PER HR.	5.00	5.70	5.00	5.00	5.00
RECOMMENDED LIGHTING VERTICAL	5 X 1000W	8 X 1000W	11 X 1000W	17 X 1000W	23 X 1000W
RECOMMENDED CHILLER*	1/2 HP	3/4 HP-1 HP	1 HP	1.5 HP	2 HP
RECOMMENDED RESERVOIR (GALLONS)	150	210	275	375	490
SHIPPING WEIGHT (LBS.)	175	245	315	455	595
SHIPPING BOX SIZES	PALLET	PALLET	PALLET	PALLET	PALLET

\* General Recommendation - Check Manufacturers Specifications for proper chiller sizing.

# UC Solo 8, 13 & PRO



**Solo 8 & 13 Systems Include:** 8 or 13 gallon growth module, CCH2O custom molded Lid with Porthole, CCH2O 8" Net Pot, Drain Valve Kit, Eco Air 2 Air Pump, Air Hose and (2) Medium Round Air Stones. 1-Year Warranty. Plus everything you need to get growing: Growstone™ Grow Medium and Cultured Solutions™ Veg A&B Premium Plant Nutrients.

**Solo PRO System Includes:** 35 gallon growth module, custom ABS Lid with (2) Portholes, (8) CCH2O 8" Net Pots, Drain Valve Kit, Air Force Pro 40 Ipm Air Pump, Air Hose and CCH2O Premium Air Diffuser. 1-Year Warranty. Plus everything you need to get growing: Growstone™ Grow Medium and Cultured Solutions™ Veg A&B Premium Plant Nutrients.

- Single Module Water Culture System
- Explosive Results, Great for Beginners
- Great for Mother Plants and Small Spaces
- Quick Access Lid Porthole and Convenient Garden Hose Drain Valve
- Easy to Use, Just Add Water!

UC SOLO	UCSOLO8	UCSOLO13	UCSOLOPRO
SIZE (INCHES)	16 X 13 X 13	16 X 13 X 19	26 X 32 X 12
FULL SYSTEM VOLUME (GALLONS)	6	10	30
POWER USAGE (WATTS)	4	4	1.1A
AIR PUMP(S)	ECO AIR 2	ECO AIR 2	AFP-40
SHIPPING WEIGHT (LBS.)	10	10	30
SHIPPING BOX SIZES	16 X 14 X 13	16 X 14 X 19	28 X 34 X 14

# Under Current™ Accessories

## CCH20 Lids



Our proprietary injection molded CCH20 Lids are available in 8" (standard), 5.5" and without hole (used on our Epicenter). These new lids offer improved structural integrity, as well as a convenient removable port hole for air hose entry and easy monitoring of the rootzone without disturbing the plant. Made in CA.

## CCH20 Net Pot



The new CCH20 8" Net Pot has several new features including a standardized planting deck, reinforced design and light proof upper portion. These proprietary additions ensure optimum plant health during the growth and bloom cycle. Made in CA.

## UC Spin Tight Bulkhead



In our never ending efforts to bring relevant products to modern growers we are proud to now offer our proprietary UC Spin Tight 2" & 3" Bulkhead to the hydroponics industry. Our new Spin Tight Bulkheads now come standard on all Under Current systems to improve ease of use and increase the longevity of the Growth Modules by reducing the stresses incurred on the plastic. These extremely useful bulkheads can be used in a wide variety of applications such as hydroponics, aquaculture or anywhere there is a need to create a union between large reservoirs of water or nutrient solution. These exceptionally durable bulkheads are made of 100% recycled Zenoy plastic, which offers both an environmentally sustainable product as well as a supremely functional tool for growers abroad. UC Spin Tight Bulkheads are designed to retrofit existing systems with Uniseals. Made in CA.

## Air Force™ Pro Air Pumps



	Airflow (LPM)	Rated Pressure (PSI)	Amp (A)	Voltage (VAC)	Frequency (Hz)
AF-15	19	1.4	0.43	120	60
AF-40	47	1.8	1.1	120	60
AF-60	68	2.1	1.7	120	60
AF-80	86	2.1	1.9	120	60

The Air Force Pro™ Air Pumps are designed to minimize noise and vibration while providing high volumes of air at low pressure. Constructed of a solid aluminum body for enhanced durability, these pumps feature an oil-less compressor which allows for maximum longevity and easy maintenance. Air Force Pro™ Air Pumps are included with all Under Current™ Systems and have a 2-Year Limited Warranty.

## Module Cage



Designed by CCH20, the Module Cage is the perfect support option for large Under Current™ style plants. Standing 48" tall and made from durable galvanized steel, the Module Cage fits both our 8 and 13 gallon Growth Modules. Module Cages can be used repeatedly and are easy to install with a wrap around clasp design, even with plants already growing. Made in the USA.

## UC Hoodie & UC Parka



UC Hoodies™ made by High Caliper (Smart Pots™) are designed to enhance the UV resistance of our growth module (especially in greenhouse and outdoor applications) and add an additional thermal layer to aid in system cooling. Available in both 8 and 13 gallon sizes. Made in USA.

Designed by CCH20, the UC Parka adds a reflective and insulation layer to the Growth Module. By reflecting light and retaining cool, the UC Parka helps your lighting and water cooling work more efficiently. Available in both 8 and 13 gallon sizes. Made in the USA.

# Hydro Accessories

## "Black Out" Series Growth Module



The new and improved "Blackout" series Under Current™ Growth Modules have several new features including: superior UV resistance, increased durability due to proprietary additives and non-translucent walls, all promoting maximum module longevity. Made In USA Of Food Grade High Density Poly Ethylene

## Air Diffusers



Medium Round Airstones are used to aerate the individual growth modules of the Under Current™. They are durable, reusable (up to 3 runs) provide a fine bubble output and are easy to clean. The 9" Diffuser Disc provides unmatched oxygen transfer efficiency within the Epicenter™. The 9" Diffuser Disc comes standard with a fine bubble premium quality membrane. These proprietary membrane materials are engineered for superior product life. An integral triple check valve feature prevents the backflow of liquid into the diffuser and piping. The 9" Diffuser Disc is ideally suited for hydroponics applications and requires minimal maintenance for long-term performance. A 9" Diffuser Disc comes standard in the Epicenter Complete, Epicenter with Disc, and all Under Current™ Systems and is suitable for any aeration application.

## Float Valve Kit



The Float Valve Kit is used to maintain the correct water level in the Under Current™ or any hydroponics reservoir. It features an adjustable PVC float valve with 3/8" quick connect fitting to easily adapt to a water filter, top-off reservoir or freshwater source.

## Float Kit with Reservoir Adapter



The Float Valve Kit with Reservoir Adapter includes everything you need to start automatically topping off your Under Current™ or hydroponics system from a reservoir. It includes an adjustable PVC float valve with 3/8" quick connect fitting, 4ft. of 3/8" RO tubing and a Reservoir Adapter Kit with 3/8" quick connect fitting, on/off valve and Uniseal for easy installation. Made in CA.

## Reservoir Adapter Kit



The Reservoir Adapter Kit is an easy to use bulkhead designed to connect a reservoir to a float valve. Includes a 3/8" quick connect fitting, on/off valve and patented Uniseal for quick and easy installation. Comes standard with all Under Current™ models. Made in CA.

## Drain Valve Kit



The Drain Valve Kit can be mated to any size reservoir to provide a convenient drain outlet with standard garden hose threads. Includes a removable cap, on/off valve and patented Uniseal for quick and easy installation. Comes standard with all Under Current™ models. Made in CA.

# Hydro Accessories

## Premium Air Pumps Alita™ & Hi-Blow™



Designed to deliver high volumes of steady airflow at low-pressure ranges, Alita™ & Hi-Blow™ Linear Air Pumps are of high efficiency, low energy consumption and perform with low operation noise. With no sliding parts and oil-less components, these air pumps require no lubrication and transfer air without any contamination. Great for water culture or any garden application.

## Mag-Drive™ Water Pump

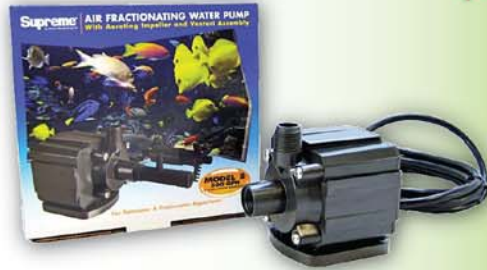

Magnetic drive utility pumps are made to run continuously, without seals to wear out. Compact and highly energy efficient Mag-Drive pumps are used as the Return Pump to propel the Sub-Current Culture™ in all Under Current™ Systems and are suitable for any garden application. 5-Year Warranty on Pump Housing, 1-Year Warranty on Impeller. Made in USA

## In-Line Filter



In-Line Spin-Clean® Filters are designed to keep roots and other debris from entering the Return Pump. The durable plastic construction is light weight and chemical resistant. Unique Spin-Clean™ centrifugal action keeps the stainless screen clean far longer than any conventional screen filter of the same size, greatly extending service intervals. Two-piece threaded housing with O-ring seal makes maintenance easy. Made in CA.

## Uniseal®



Uniseal are a cost effective alternative to bulkheads. Made of DuPont Alcryn® rated to 40 psi and warranted for 25 years. UniSeals are immune to cold, will not harden and hold pressure and vacuum. All sizes correspond to standard Schedule 40 PVC pipe. Fits tank wall thicknesses up to 1/2". UniSeals® are used in all Under Current™ Systems and are suitable for any garden application. Made in USA.

## CCH20™ Hose Air & Water



Return Hose - 3/4" ID Black PVC Hose. Connects the Return Pump to the Return Manifold. Return Hose is used in all Under Current™ Systems and is suitable for any garden application. Made in CA.

Air Hose - 3/16" ID x 100ft. Clear or Black PVC Hose. Connects the Air Stones to the Air Manifold. The Air Hose is used in all Under Current™ Systems and is suitable for any garden application. Made in CA.

## Cool Coil™



A 12" stainless steel coil that is designed to be used with a water-cooled system. Chilled fresh water is pumped through the coil which should be submerged in the nutrient reservoir. The fresh water used to cool the reservoir does not mix with the water in the reservoir. Includes 20' of 3/8" heavy duty tubing, 1/2" and 3/8" brass hose barb adapters, and stainless steel hose clamps. \* Requires chilled water flowing through it to operate. Made in USA.



## Usage Instructions

Cultured Solutions™ is formulated so that when used with tap water (100-150 ppm) it does not necessitate the use of additives such as Cal/Mag. When tap water is in excess of 250 ppm we recommend the use of a reverse osmosis filter.

When using reverse osmosis water add Cal/Mag @ 1-3 ml/gal to ensure an appropriate ratio of Ca to Mg is achieved before adding in Cultured Solutions™.

For applications where all parameters such as lighting, CO2, RH and temps are dialed in, increase recommended dosage of all nutrients by 15-25% and monitor plants to optimize proper dosages.

For greenhouse applications it may be necessary to increase dosages by 15-25% to maximize plant production given the increase in lighting concentrations. Conversely, in lower light applications it may be necessary to decrease concentration slightly so as not to push plants beyond the given parameters at hand.

For soil or soilless applications it is recommended to leach with UC Roots periodically to aid in the avoidance of toxic mineral salt build ups. If pushing the plants with higher ppm regimes be sure to leach weekly.

## Water Culture (0.75 lpm aeration/gal)

mL per Gallon	1	2	3	4	1	2	3	4	5	6	7	8	Flush
UC ROOTS	1-2	1-2	1-2	1-2	1-2	1-2	1-2	1-2	1-2	1-2	1-2	1-2	5
CS VEG A	2	3	4	5	2.5								
CS VEG B	2	3	4	5	2.5								
CS BLOOM A					2.5	6	6	7	7	6	3	2	
CS BLOOM B					2.5	6	6	7	7	6	3	2	
CS BUD BOOSTER							3	5	7	8	10	8	
PPM (500 Scale)	150	200	250	300	300	400	500	600	700	750	600	400	0
PPM (700 Scale)	210	280	350	420	420	560	700	840	980	1050	840	560	0
EC	0.3	0.4	0.5	0.6	0.7	0.8	1	1.2	1.4	1.5	1.2	0.8	0

## Supercharged Water Culture (1.5 lpm aeration/gal)

mL per Gallon	1	2	3	4	1	2	3	4	5	6	7	8	Flush
UC ROOTS	1-2	1-2	1-2	1-2	1-2	1-2	1-2	1-2	1-2	1-2	1-2	1-2	5
CS VEG A	1	1.5	2	2.5	2.5								
CS VEG B	1	1.5	2	2.5	2.5								
CS BLOOM A					2.5	6	6	7	7	6	3	2	
CS BLOOM B					2.5	6	6	7	7	6	3	2	
CS BUD BOOSTER							3	5	7	8	10	8	
PPM (500 Scale)	75	100	125	150	150	200	250	300	350	375	300	200	0
PPM (700 Scale)	105	140	175	210	210	280	350	420	490	525	420	280	0
EC	0.15	0.2	0.25	0.3	0.35	0.4	0.5	0.6	0.7	0.75	0.6	0.4	0

## Soilless / Coco

mL per Gallon	1	2	3	4	1	2	3	4	5	6	7	8	Flush
UC ROOTS	1-2	1-2	1-2	1-2	1-2	1-2	1-2	1-2	1-2	1-2	1-2	1-2	5
CS VEG A	4	6	8	10	5								
CS VEG B	4	6	8	10	5								
CS BLOOM A					5	12	12	14	14	12	6	4	
CS BLOOM B					5	12	12	14	14	12	6	4	
CS BUD BOOSTER							6	10	14	16	20	16	
PPM (500 Scale)	300	400	500	600	600	800	1000	1200	1400	1500	1200	800	0
PPM (700 Scale)	420	560	700	840	840	1120	1400	1680	1960	2100	1680	1120	0
EC	0.6	0.8	1.0	1.2	1.4	1.6	2.0	2.4	2.8	3.0	2.4	1.6	0

# CCH20 General Recommendations

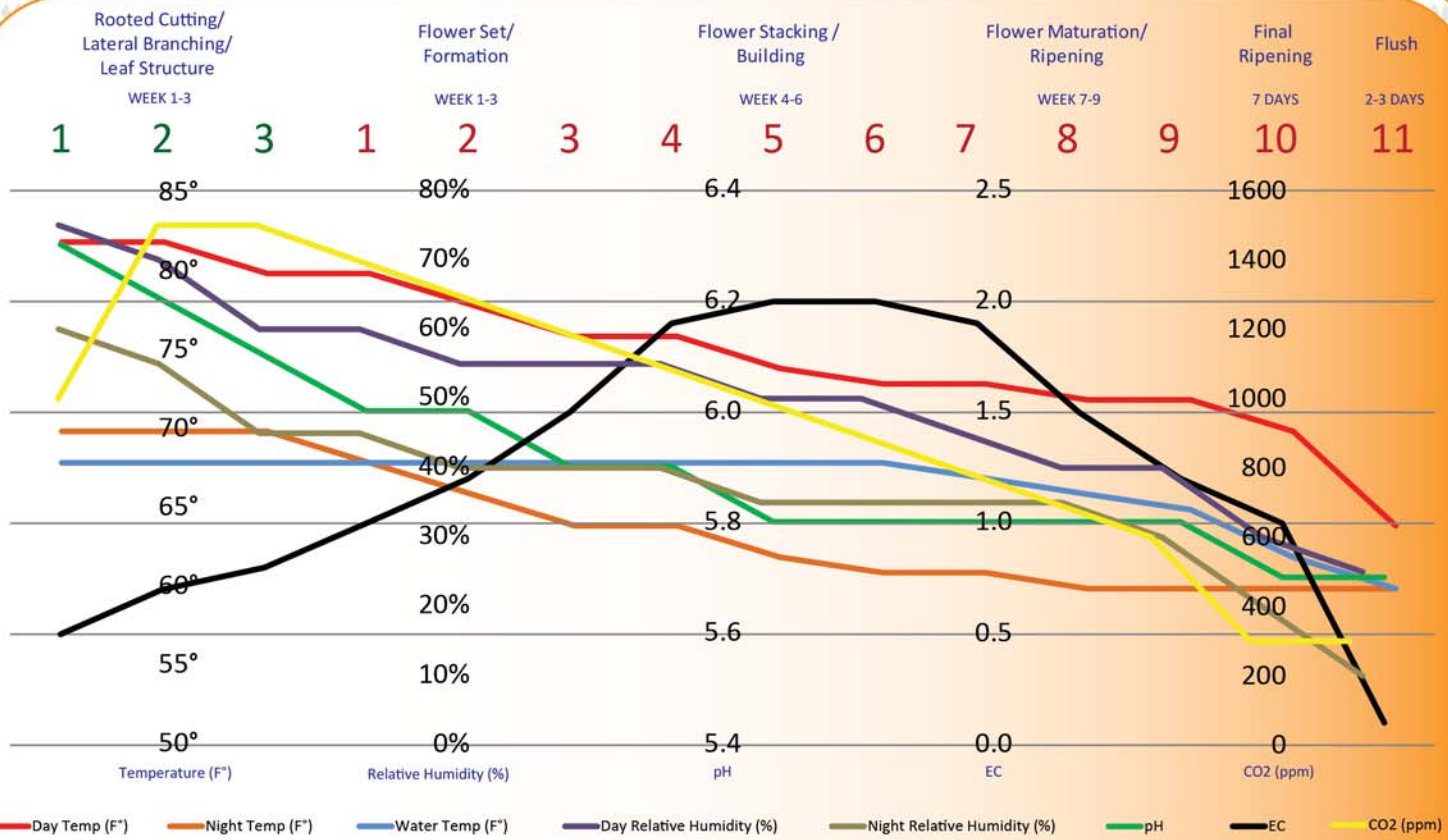

Plant Growth Stage →	Rooted Cutting/Lateral Branchin/Leaf Structure			Flower Set/Formation			Flower Stacking/Building			Flower Maturation/Ripening			Final Ripening	Flush
Weeks →	1	2	3	1	2	3	4	5	6	7	8	9	7 Days	2-3 Days
Day Temp (F°)	82°	82°	80°	80°	78°	76°	76°	74°	73°	73°	72°	72°	70°	64°
Night Temp (F°)	70°	70°	70°	68°	66°	64°	64°	62°	61°	61°	60°	60°	60°	60°
Day Relative Humidity (%)	75%	70%	60%	60%	55%	55%	55%	50%	50%	45%	40%	40%	30%	25%
Night Relative Humidity (%)	60%	55%	45%	45%	40%	40%	40%	35%	35%	35%	35%	30%	20%	0-20%
pH	6.3	6.2	6.1	6.0	6.0	5.9	5.9	5.8	5.8	5.8	5.8	5.8	5.7	5.7
EC	0.5	0.7	0.8	1.0	1.2	1.5	1.9	2.0	2.0	1.9	1.5	1.2	1.0	0.1
CO2 (ppm)	1000	1500	1500	1400	1300	1200	1100	1000	900	800	700	600	300	300
Water Temp (F°)	68°	68°	68°	68°	68°	68°	68°	68°	68°	67°	66°	65°	62°	60°

**Room Considerations:** The Under Current™ is a high performance hydroponics system and should be complimented by a high performance growing environment. To get the best results, all aspects of the grow space should be optimized including: day and night temperatures, humidity, light levels, CO2 and air movement.

**Optimal Water Temps:** Using a water chiller to maintain water temps between 65-68° will allow for the highest levels of dissolved oxygen and discourage proliferation of harmful bacteria to ensure explosive root growth. Cooler water temps in the system will also act as a heat sink in your grow space and allow for slightly warmer room temps required for full CO2 absorption.

**Water Levels:** Water levels should be maintained fairly high throughout the growth and bloom cycle encouraging dense lateral root growth from the net pot. In the later parts of bloom and as roots fill the Growth Module, water levels can be incrementally adjusted down exposing more of the root mass. Creating drought like conditions in late bloom helps hasten flower formation and essential oil production.

**Top-Off Reservoir:** Using a top-off reservoir will allow you to maintain consistent water levels and follow weekly feeding schedules without dumping valuable nutrient solution. When optimized, a top-off reservoir can be used like a doser for incremental EC/ppm adjustments and pH steering.

**Adjusting pH & EC/ppm:** Adding concentrated pH adjusters or nutrients directly to the system may result in extreme plant/root shock. Anything added directly to the system should be diluted to at least 20% and added slowly. For best results pH and EC/ppm adjustments should be done through the top-off reservoir.

**Nutrient Considerations:** Highly chelated, clean, synthetic nutrients such as our Cultured Solutions™ line have proven to work best in water culture both for their pH stability and ability to stay viable in solution for longer periods. Adding organics, sugars, bacteria, and zyme products have shown to create potentially harmful biofilms, hinder pH stability and require more frequent nutrient change outs.

**Nutrient Strength:** If not using Cultured Solutions™, we typically recommend starting between ¼ and ½ strength of standard nutrient recommendations. When starting with rooted cuttings transplant into the system at 0.3 EC or 200ppm and increase 10-20% per week based on plant performance. \*\*When supercharging aeration levels nutrients should be reduced even further.

**Nutrient Change Outs:** When plants are feeding and growing normally, full nutrient change outs are beneficial every 14-21 days. If pH levels become unstable or nutrient levels start to rise or stagnate this may be a good indication to do a full or partial change out. When using more complex nutrient recipes or heavy organic inputs more frequent (every 7-10 days) nutrient change outs may be necessary.

**Cleaning the System:** Cleaning the system between runs is an important step to ensure harmful mineral buildups and biofilms are removed before restarting. Fill the system with plain water and a cleaning solution such as bleach. Cycle the system for 24hrs, scrub the modules and bottle brush the joints and manifolds. Thoroughly rinse the system and any debris, allow to completely dry before filling to start a new cycle.

# Grow Room Layouts



## Tent & Hut

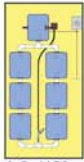

4x8 - UC6

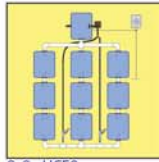

8x8 - UCE9

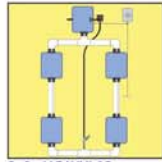

8x8 - UC4XXL13

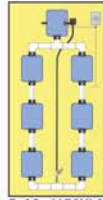

5x10 - UC6XL13

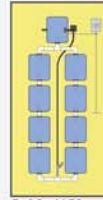

5x10 - UC8

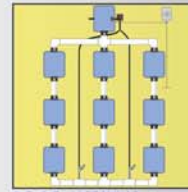

9.5x9.5 - UCE9XL13

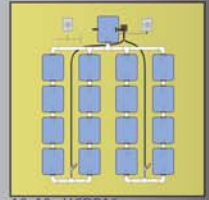

10x10 - UCDB16

## Residential & Hobby

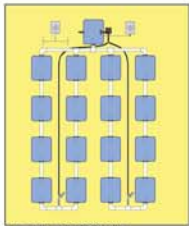

10x12 - UCDB16XL

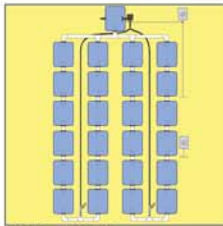

12x12 - UCDB24

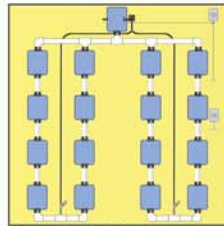

12x12 - UCDB16XL13

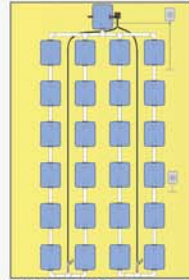

10x15 - UCDB24XL



10x15 - UCDB32

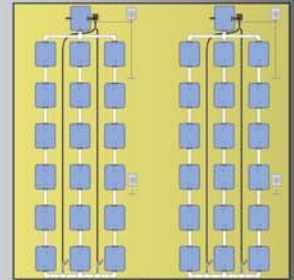

15x15 - (2) UCE18XL

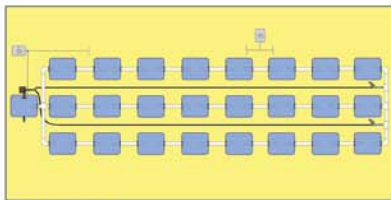

10x20 - UCE24XL

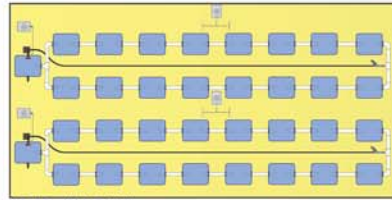

10x20 - (2) UC16XL

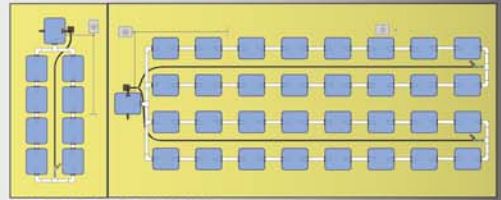

5x10 + 10x20 - UC8, UCDB32XL

## Commercial

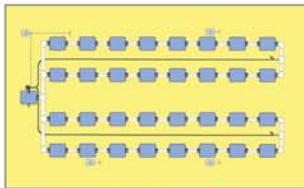

15x25 - UCDB32XL13

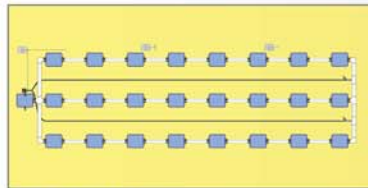

15x30 - UCE24XXL13

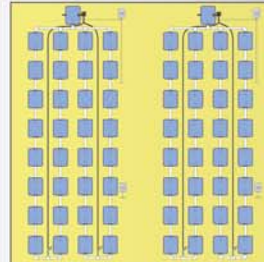

20x20 - (2) UCDB32XL

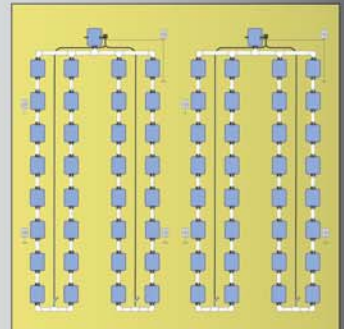

20x20 - (2) UCDB32XL13

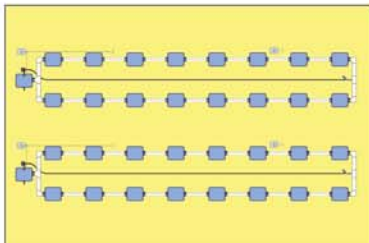

20x30 - (2) UC16XXL13

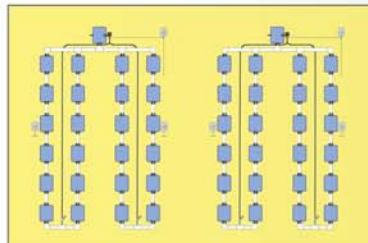

20x30 - (2) UCDB24XL13

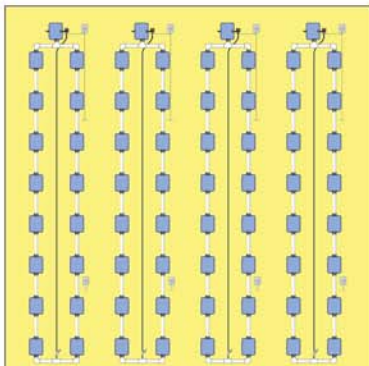

30x30 - (4) UC16XXL13

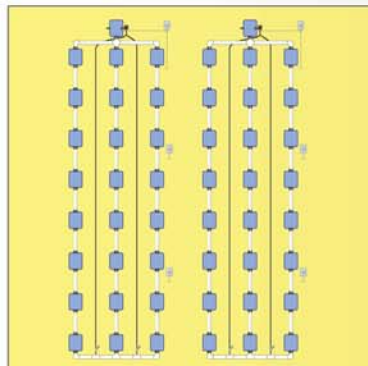

30x30 - (2) UCE24XXL13

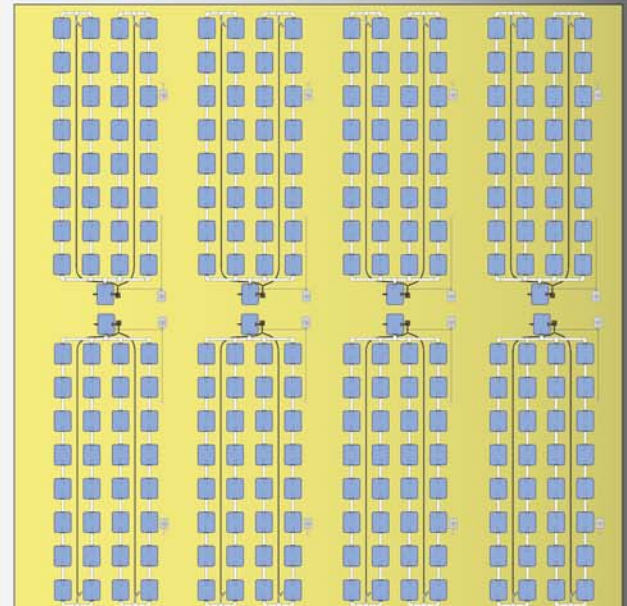

40x40 - (8) UCDB32XL