

# Assembly Instructions

## Under Current

RE-CIRCULATING WATER CULTURE SYSTEM

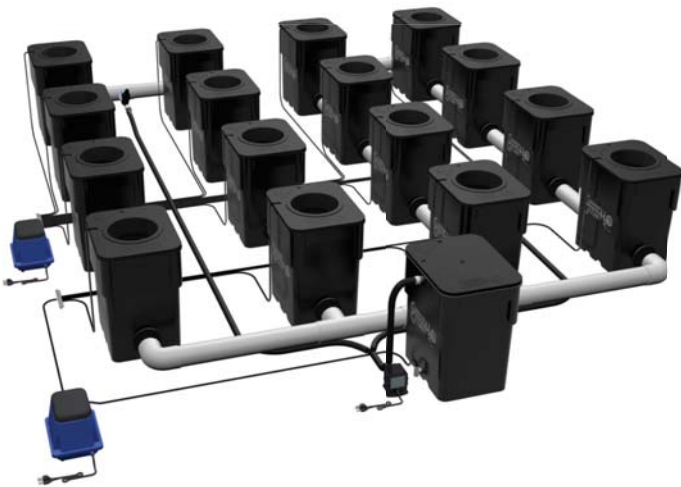
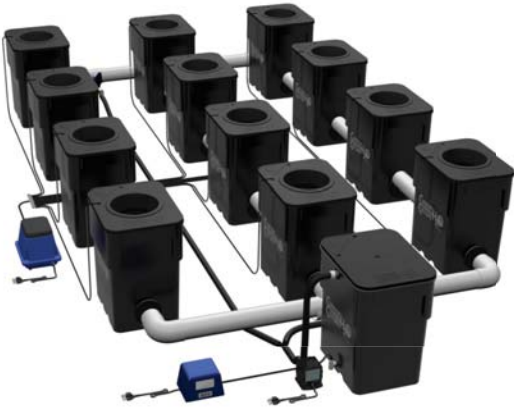
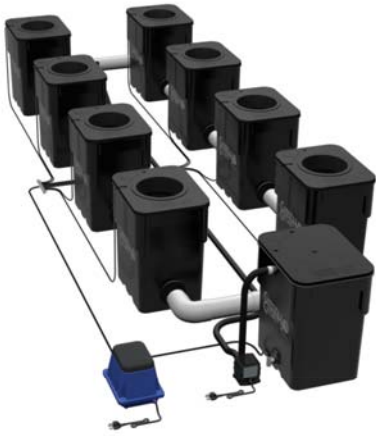

2013 v1

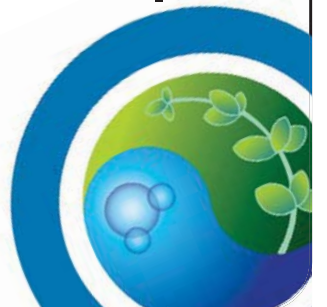

# Parts



EPICENTER



GROWTH MODULE



JOINT



UC SPIN TIGHT BULKHEAD



RETURN MANIFOLD



DELIVERY MANIFOLD



RETURN PUMP



RETURN PUMP MANIFOLD

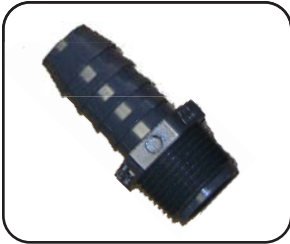

RETURN PUMP INLET



AIR PUMP



AIR STONE



AIR HOSE



MULTI SPLITTER

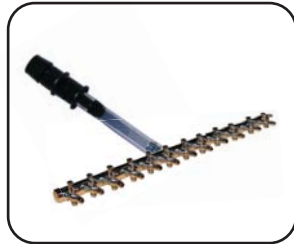

SPLIT 12



SPLIT 16/24

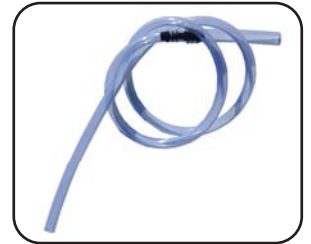

EPI HOSE



DRAIN VALVE



NET POT



FLOAT VALVE



FLOAT VALVE QUICK CONNECT



UNI SEAL



LID



RETURN PUMP DIFFUSER



RETURN HOSE



DIFFUSER DISK



IN-LINE FILTER



EVO SPLITTER



RESERVOIR ADAPTER



RESERVOIR HOSE



MANIFOLD CRUTCH



GARDEN HOSE DRAIN ADAPTER



CHILLER ADAPTER



CULTURED SOLUTIONS

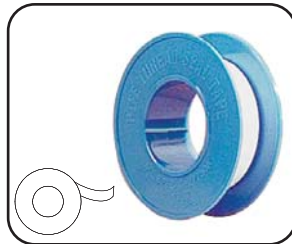

TEFLON TAPE



BLUE MAGIC



SCISSORS

TOOL REQUIRED  
\*NOT INCLUDED

## Assembly Instructions

1. Unbox. Lay out all components for easy identification.
2. Layout GROWTH MODULES in chosen pattern, with EPICENTER at one end.
  - a. Under Current (UC): Two Rows
  - b. Under Current Evolution (UCE): Three Rows
  - c. Under Current Double Barrel (UCDB): Four Rows

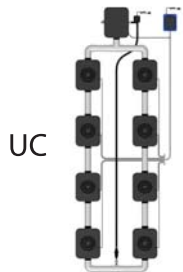

UC

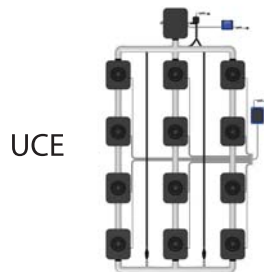

UCE

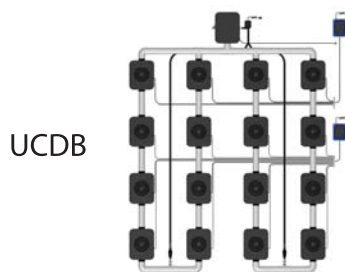

UCDB

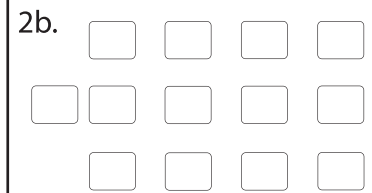
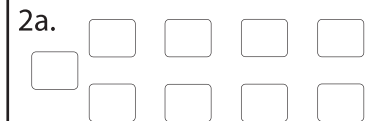

3. Locate plastic bag with UC Spin Tight Bulkhead "NUT KIT". Install the flat rubber Gasket to MAIN BULKHEAD BODY, this will seal against the outside of the GROWTH MODULE. Install the large O-Ring to the BULKHEAD NUT, this will seal against the inside of the GROWTH MODULE.

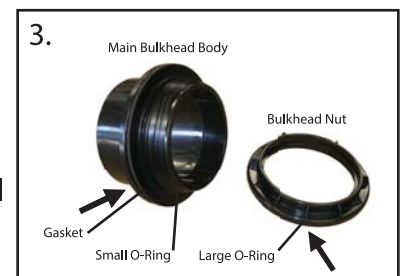

#### 4. Assemble DELIVERY/RETURN MANIFOLDS (\*\*Only on Evolution and Double Barrel Systems).

For larger Under Current® systems your DELIVERY/RETURN MANIFOLDS may arrive in two (Evolution) or three (Double Barrel) sections. To assemble manifold sections apply a bead of BLUE MAGIC™ (Included) to the inside of the slip fitting. Slide PVC completely into slip fitting at a 90° degree orientation from desired placement. Once inserted, turn PVC into place by rotating until desired placement is achieved (align dots). PVC glue may be used for a more permanent installation.

\*\*Boneless Systems: Use a table or flat surface to lay out all fittings. Cut all PVC fittings at a 90°, dry fit sections for proper spacing. Apply PVC glue (NOT Included) to PVC sections, twist into place.

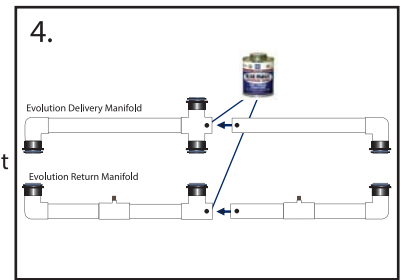

#### 5. Install DELIVERY MANIFOLD into EPICENTER.

Insert the Main Bulkhead Body into the GROWTH MODULE, seat the bulkhead in the hole so that the gasket is flat and tight against the module wall. When properly seated, the BULKHEAD will click into the hole. Install the Bulkhead Nut with O-Ring on the inside of the GROWTH MODULE, tighten until a good seal is achieved. Visually inspect the connection for gaps, if you see any gaps loosen and re-seat the Main Bulkhead Body.

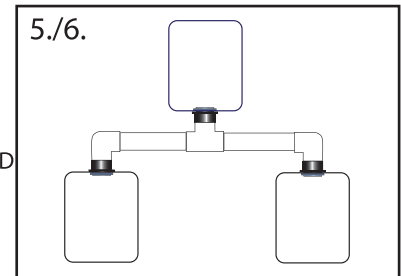

#### 6. Connect first row of GROWTH MODULES to DELIVERY MANIFOLD.

#### 7. Connect remaining GROWTH MODULES with JOINTS.

#### 8. Locate RETURN MANIFOLD(S).

a. For large Evolution and Double Barrel Systems: RETURN MANIFOLD may need assembly. Use included BLUE MAGIC on all slip connections.

#### 9. Install INLINE FILTER(S) on RETURN MANIFOLD(S).

- Use included TEFLON TAPE for all connections.
- Thread 3/4" BALL VALVE to RETURN MANIFOLD nipple, thread IN-LINE FILTER to 3/4" BALL VALVE, thread 3/4" BARB X 3/4" FPT to IN-LINE FILTER. Orient IN-LINE FILTER housing up.
- For Evolution and Double Barrel Models repeat these steps for the second IN-LINE FILTER.
- If installed, remove Green Plastic Piece from inside FILTER housing and discard. Make sure IN-LINE FILTER housing and threaded cap are tightened completely.

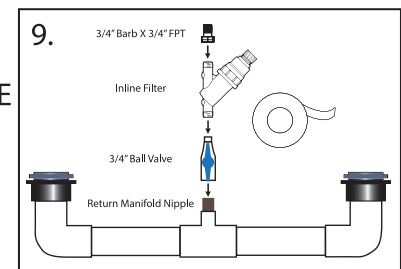
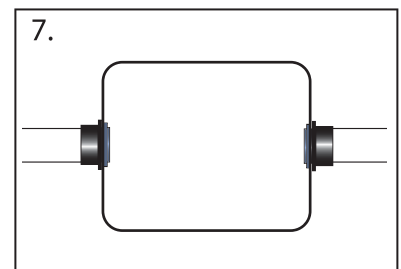
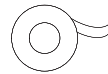

#### 10. Install RETURN MANIFOLD(S) to last row of GROWTH MODULES.

- Repeat this step for all Double Barrel systems.
- For 13 Gallon Systems: Place MANIFOLD CRUTCH(S) under RETURN/DELIVERY MANIFOLD pipe at all corners.

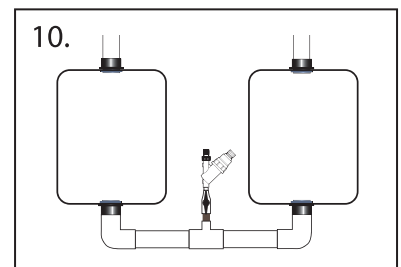

#### 11. Locate RETURN PUMP and remove from box.

- Discard filter that may have been include with RETURN PUMP.

#### 12. Wrap RETURN PUMP INLET with TEFLON TAPE and screw into RETURN PUMP.



#### 13. Wrap pump outlet with TEFLON TAPE attach RETURN PUMP MANIFOLD to pump outlet.

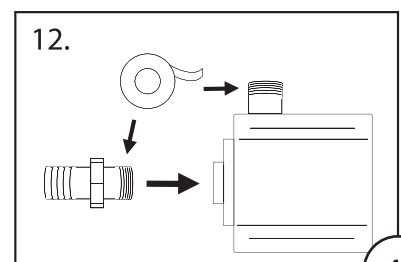

14. Install RETURN PUMP DIFFUSER in upper EPICENTER UNISEAL by pulling tee off then replacing once completed.

15. Connect RETURN PUMP MANIFOLD to 3/4" barb on RETURN PUMP DIFFUSER.

16. Install 3/4" RETURN HOSE between RETURN PUMP INLET and IN-LINE FILTER barb. Cut to length with scissors.

- a. For 8/13 Gallon EVOLUTION and DOUBLE BARREL Systems the RETURN PUMP will pull from two locations: Install EVO SPLITTER on RETURN PUMP INLET.

17. Attach LIDS to each MODULE, remove PORT HOLE COVER.

18. Remove AIR PUMP(S) from box and place parallel to system, use pump box(s) to elevate AIR PUMP(S) off the ground.

19. Attach AIR PUMP MANIFOLD(S) to corresponding AIR PUMP(S) outlet. Install rubber elbow included in AIR PUMP box to AIR PUMP outlet. Each Under Current® model includes specific air pump(s) and air manifold(s). Depending on which model you purchased your air delivery system will be setup with one or more of the following four AIR MANIFOLDS below:

- a. For MULTI SPLITTER: Attach shorter length clear hose from MULTI SPLITTER to black barb on EPICENTER.
- b. For SPLIT 12: Attach to AIR PUMP and place at center of system.
- c. For SPLIT 16/24: Attach to AIR PUMP and place at center of system.
- d. For EPI HOSE: Install 3/8" barb to AFP-15 AIR PUMP outlet and attach larger side of EPI HOSE. Connect smaller side to black barb on EPICENTER.
- e. NOTE: When using high concentrations of CO2 we recommend placing AIR PUMP(S) outside of the grow space.

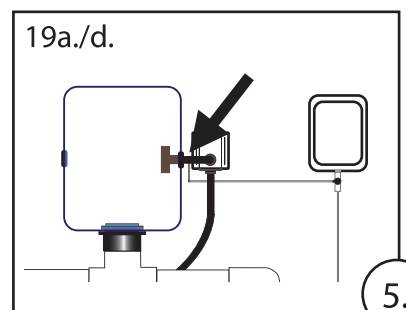
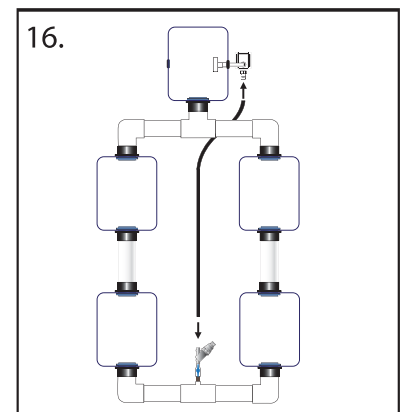
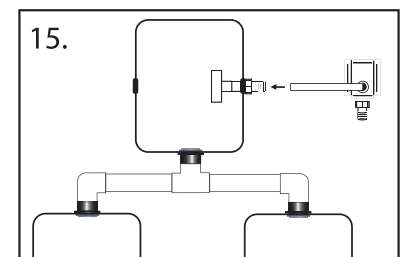
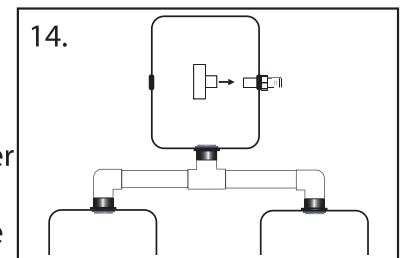
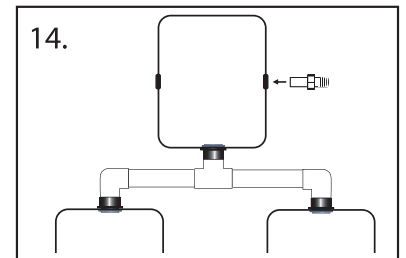
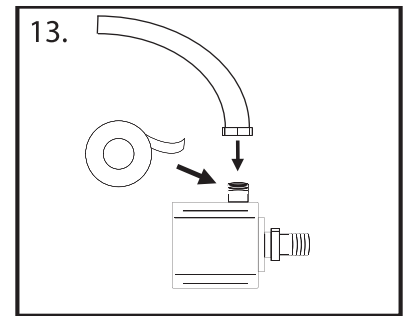
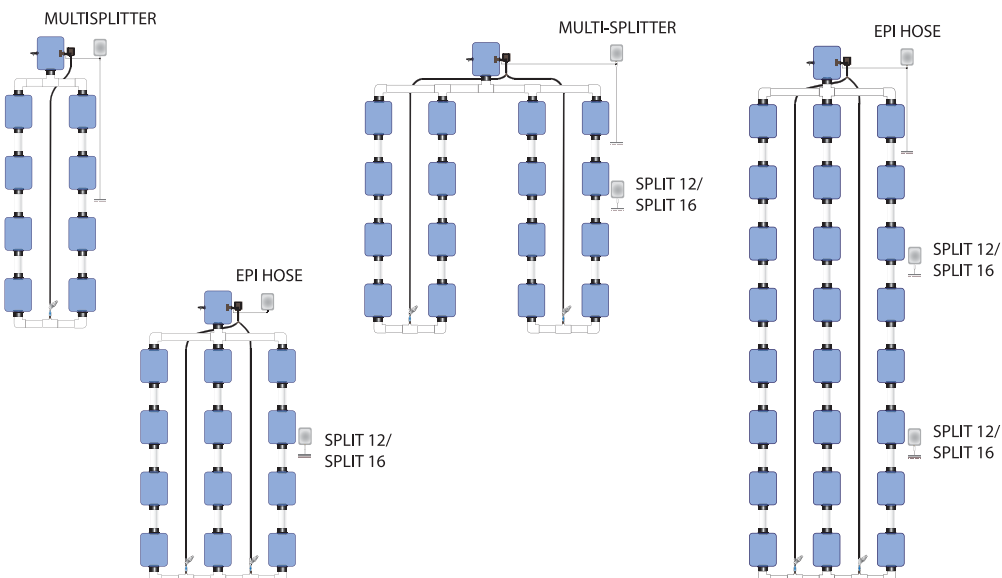



20. NOTE: Make sure white tee on EPICENTER outside is straight up and down. This tee acts as a counter balance to the DIFFUSER DISK inside the EPICENTER.

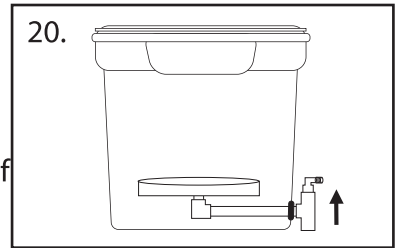

21. Open AIR HOSE by cutting a hole in the center of the roll, place at bottom of first GROWTH MODULE. Pull AIR HOSE up and out through PORT HOLE in LID and connect to chrome air diffuser on AIR PUMP MANIFOLD. Leave 12-18" of AIR HOSE in GROWTH MODULE and cut. Repeat for every GROWTH MODULE.

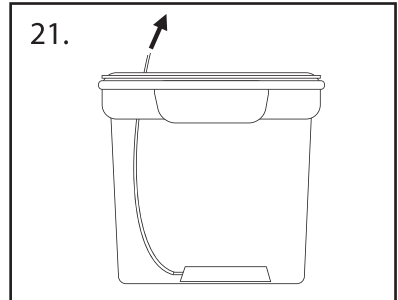

a. NOTE: For some smaller systems not all outlets on the chrome air diffuser will be utilized, close valves.

22. Remove all AIR STONE(S) from packaging. Attach AIR STONE(S) to cut end of AIR HOSE in each GROWTH MODULE and rest at bottom.

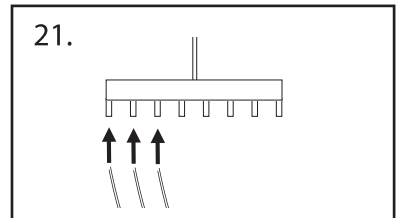

23. Install PORT HOLE COVER(S) on each LID.

24. Install DRAIN VALVE in lower UNISEAL on EPICENTER. Make sure DRAIN VALVE is closed.

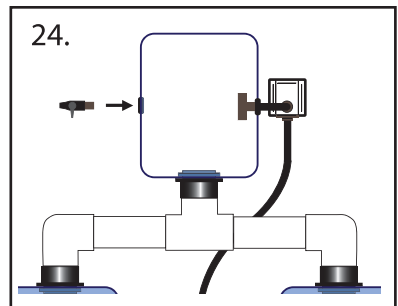

25. Install FLOAT VALVE in upper EPICENTER Lip through pre-drilled hole with rubber washer inside EPICENTER. Orient FLOAT VALVE so that it can adjust down. Secure with plastic nut, tighten nut down completely to ensure a good seal.

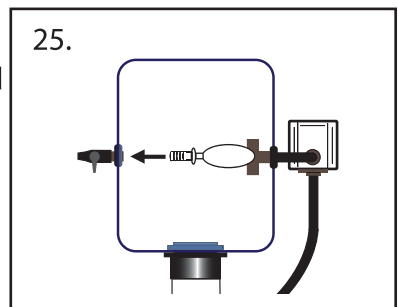

26. Apply TEFLON TAPE to threaded input on FLOAT VALVE. Screw on FLOAT VALVE QUICK CONNECT.

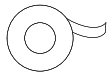

27. Inspect all system connections. Make sure all threaded unions are taped. Test fill system to just above BULKHEADS and run to check for leaks. Adjust and tighten BULKHEADS as necessary. If a leak is discovered call CCH2O @ 559-266-4769 for a support or a replacement part if necessary.

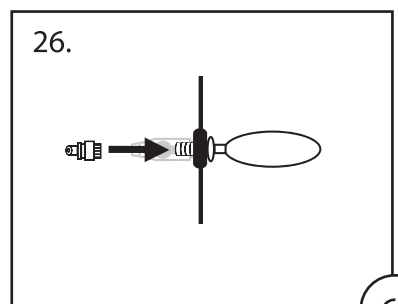

## Reservoir Installation

1. Attach a top-off reservoir to the FLOAT VALVE using the RESERVOIR ADAPTER KIT.

- Drill 1-1/4" hole near base of desired reservoir, install UNISEAL and RESERVOIR ADAPTER. Connect RESERVOIR ADAPTER to FLOAT VALVE QUICK CONNECT with RESERVOIR HOSE.
- Reservoir should be elevated above EPICENTER.
- RESERVOIR HOSE can be lengthened to place reservoir further away from EPICENTER.

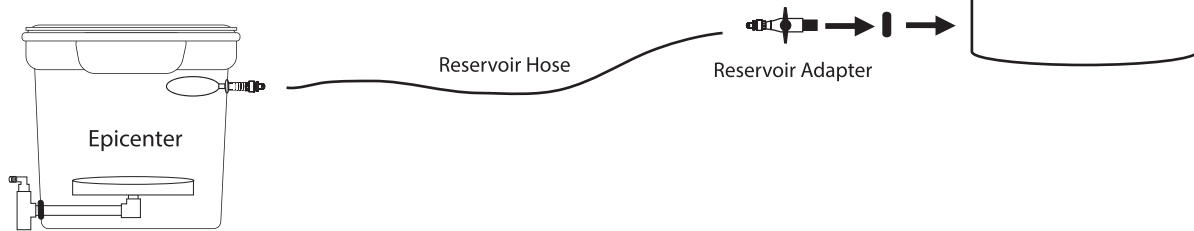

## Water Chiller Installation

The Under Current® can easily be adapted to a water chiller in one of the following ways:

- Remove the tee from the RETURN PUMP DIFFUSER inside the EPICENTER, attach the included CHILLER ADAPTER fitting, attach 3/4" hose (not included) from the CHILLER ADAPTER fitting to the chiller inlet. Attach 3/4" hose (not included) from the chiller outlet back to the EPICENTER.
- Remove the center section of the RETURN PUMP MANIFOLD, attach 3/4" hose (not included) from the output barb on the RETURN PUMP to the chiller inlet. Attach 3/4" hose (not included) from the chiller outlet back to the inlet barb on the RETURN PUMP DIFFUSER.
- For cooling multiple Under Currents®, insert Cool Coil® into each EPICENTER.

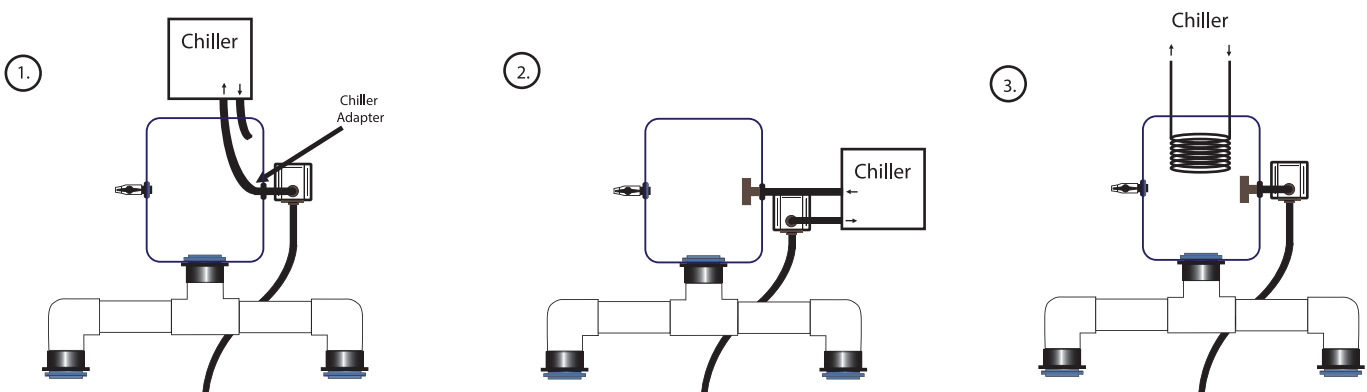

### **Filling the System with Water and Nutrients (Without Plants in System)**

1. Adjust FLOAT VALVE to desired water level.
2. Be sure to use only the purest water possible, Reverse Osmosis/ UV Sterilized is best.
3. Begin filling the system to recommended level.
  - a. For all 8, 13 and 35 gallon systems: Maintain water level halfway up NET POT or 3" below GROWTH MODULE upper lip.
4. Once filled, plug in AIR PUMP(S) and RETURN PUMP.
5. Add desired nutrient to EPICENTER.
6. Depending on size of transplants adjust your TDS/EC between ¼- ½ of normal nutrient manufacturer's recommendations.

### **pH Balancing (Without Plants in System)**

1. Add desired pH adjuster to EPICENTER.
2. Allow solution pH to stabilize (Approx 15-30 mins).
3. Once solution is balanced, introduce plants.

### **Introducing Plants into the Under Current**

1. Rinse grow rocks/stones thoroughly before use.
2. Fill NET POT to a 2" depth with rocks/stones.
3. Rest bare root seedling/cutting on rock/stones and gently fill remaining space up to about 1" from the top lip of NET POT.
  - a. Adjust system water level to top of root crown.
  - b. If using rockwool cutting adjust water level to just below rockwool cube.
4. Place NET POT into the LID on top of each GROWTH MODULE.

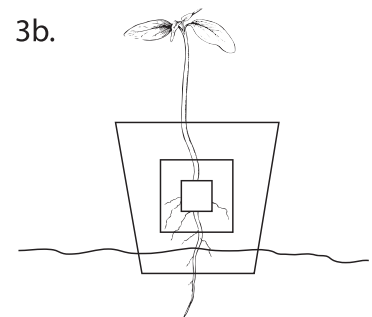
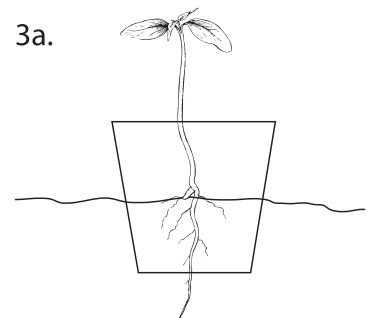



## **Draining the System**

Draining the system can be done in two ways:

1. Turn off RETURN PUMP. Attach GARDEN HOSE DRAIN ADAPTER to the female side of a garden hose. Remove the tee from the RETURN PUMP DIFFUSER inside the EPICENTER and attach the GARDEN HOSE DRAIN ADAPTER. Turn RETURN PUMP on. Monitor water level as system drains to not let RETURN PUMP run dry.
  - a. This will drain system to within 1". Top off system with fresh water while draining to dilute remaining solution.
2. Remove cap from DRAIN VALVE. Attach female side of garden hose to DRAIN VALVE. Run garden hose to desired location (Preferably a lower elevation than the DRAIN VALVE). Open DRAIN VALVE.
  - a. This will drain system to within 1". Top off system with fresh water while draining to dilute remaining solution.

## **Cleaning the System (Without Plants in System)**

1. Pull out root mass and discard air stones.
2. Remove debris from the system with a shop vac.
3. Wipe down air hose, net pots and lids with sterilizing solution on a green pad or wash cloth.
4. Fill the system with tap water and sterilizing solution to the top of the buckets, run for minimum 4-6 hrs.
5. Scrub inside of modules with green pad and inside joints with bottle brush.
6. Rinse out the system with a hose while draining till drain water is clear.
7. Drain remaining solution down as far down as possible.
8. Remove remaining water with shop vac or sump pump.
9. Wipe dry with a towel.
10. Let dry fully under HID lights to aid in sterilizing.

# CCH2O General Recommendations

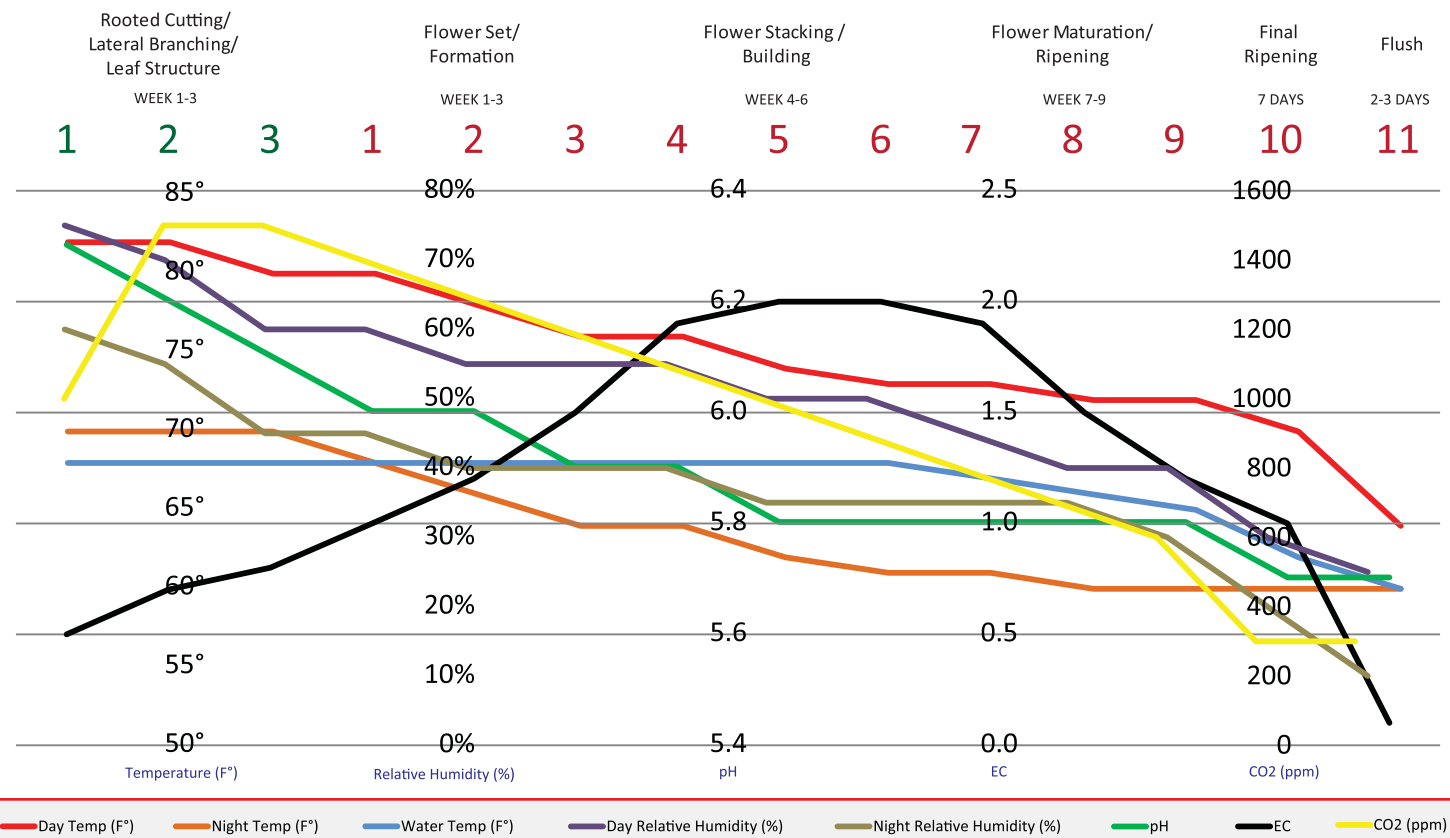

Plant Growth Stage →	Rooted Cutting/Lateral Branching/Leaf Structure			Flower Set/Formation			Flower Stacking/Building			Flower Maturation/Ripening			Final Ripening	Flush
Weeks →	1	2	3	1	2	3	4	5	6	7	8	9	7 Days	2-3 Days
Day Temp (F°)	82°	82°	80°	80°	78°	76°	76°	74°	73°	73°	72°	72°	70°	64°
Night Temp (F°)	70°	70°	70°	68°	66°	64°	64°	62°	61°	61°	60°	60°	60°	60°
Day Relative Humidity (%)	75%	70%	60%	60%	55%	55%	55%	50%	50%	45%	40%	40%	30%	25%
Night Relative Humidity (%)	60%	55%	45%	45%	40%	40%	40%	35%	35%	35%	35%	30%	20%	0-20%
pH	6.3	6.2	6.1	6.0	6.0	5.9	5.9	5.8	5.8	5.8	5.8	5.8	5.7	5.7
EC	0.5	0.7	0.8	1.0	1.2	1.5	1.9	2.0	2.0	1.9	1.5	1.2	1.0	0.1
CO2 (ppm)	1000	1500	1500	1400	1300	1200	1100	1000	900	800	700	600	300	300
Water Temp (F°)	68°	68°	68°	68°	68°	68°	68°	68°	68°	67°	66°	65°	62°	60°

**Room Considerations:** The Under Current™ is a high performance hydroponics system and should be complimented by a high performance growing environment. To get the best results, all aspects of the grow space should be optimized including: day and night temperatures, humidity, light levels, CO2 and air movement.

**Optimal Water Temps:** Using a water chiller to maintain water temps between 65-68° will allow for the highest levels of dissolved oxygen and discourage proliferation of harmful bacteria to ensure explosive root growth. Cooler water temps in the system will also act as a heat sink in your grow space and allow for slightly warmer room temps required for full CO2 absorption.

**Water Levels:** Water levels should be maintained fairly high throughout the growth and bloom cycle encouraging dense lateral root growth from the net pot. In the later parts of bloom and as roots fill the Growth Module, water levels can be incrementally adjusted down exposing more of the root mass. Creating drought like conditions in late bloom helps hasten flower formation and essential oil production.

**Top-Off Reservoir:** Using a top-off reservoir will allow you to maintain consistent water levels and follow weekly feeding schedules without dumping valuable nutrient solution. When optimized, a top-off reservoir can be used like a doser for incremental EC/ppm adjustments and pH steering.

**Adjusting pH & EC/ppm:** Adding concentrated pH adjusters or nutrients directly to the system may result in extreme plant/root shock. Anything added directly to the system should be diluted to at least 20% and added slowly. For best results pH and EC/ppm adjustments should be done through the top-off reservoir.

**Nutrient Considerations:** Highly chelated, clean, synthetic nutrients such as our Cultured Solutions™ line have proven to work best in water culture both for their pH stability and ability to stay viable in solution for longer periods. Adding organics, sugars, bacteria, and zyme products have shown to create potentially harmful biofilms, hinder pH stability and require more frequent nutrient change outs.

**Nutrient Strength:** If not using Cultured Solutions™, we typically recommend starting between ¼ and ½ strength of standard nutrient recommendations. When starting with rooted cuttings transplant into the system at 0.3 EC or 200ppm and increase 10-20% per week based on plant performance. \*\*When supercharging aeration levels nutrients should be reduced even further.

**Nutrient Change Outs:** When plants are feeding and growing normally, full nutrient change outs are beneficial every 14-21 days. If pH levels become unstable or nutrient levels start to rise or stagnate this may be a good indication to do a full or partial change out. When using more complex nutrient recipes or heavy organic inputs more frequent (every 7-10 days) nutrient change outs may be necessary.

**Cleaning the System:** Cleaning the system between runs is an important step to ensure harmful mineral buildups and biofilms are removed before restarting. Fill the system with plain water and a cleaning solution such as bleach. Cycle the system for 24hrs, scrub the modules and bottle brush the joints and manifolds. Thoroughly rinse the system and any debris, allow to completely dry before filling to start a new cycle.

### **Air Pump and water temp run 24/7?**

Yep, the inline water pump powers the negative solution displacement which drives the Sub Current Culture (SCC) method. The linear, high efficiency air pumps provide the active aeration which super charges the nutrient uptake.

### **Even during the night cycle?**

In properly aerated & balanced nutrient solution plant roots can stay submerged 24/7, even through the dark cycle. Plants continue to metabolize nutrients & exchange gases in the dark, keeping the solution moving aids in these processes.

### **How much solution is in each module?**

For 8 gallon systems we recommend an operating volume of approximately 6 gallons per module. That makes 100 gallons +/- in a 16XL (6 x 17 modules). A very small volume of solution is held in each joint (conduit) between the modules as well. For 13 gallon systems we recommend an operating volume of approximately 10 gallons per module.

### **Is it the same for the bloom cycle?**

We advise to drop the operating level to about 4 gallons per module (8 gallon) and 6 gallons per module (13 gallon) during the late fruit and flowering cycle. This helps ensure ample atmospheric oxygen uptake by the non submerged roots within the module. This oxygen exposure aids in proper fruit set and essential oil production as the plants mature. This technique can also mimic "drought conditions" which triggers the plant to produce more oils as a means of reducing transpiration rates.

### **Can the system be automated?**

Ease of use is one of the UC's main attributes. The return module (Epicenter) comes equipped with a high quality float valve built in for easy auto top-off. Each system also includes a reservoir adapter kit for plumbing straight to your favorite reservoir. We would recommend a reservoir equal to your total system volume.

### **What about auto dosing systems?**

Combining the UC with an auto doser like the Intellidose from AM HYDRO or GroBot from PureGro is a match made in ... (insert your favorite place). In this case you would plumb the UC float valve directly to a pure water source & let the Intellidose/GroBot do the rest. Of course you'll need to set the doser to your specs, but then it's on like Donkey Kong. The likelihood of a zero dump out run increases exponentially when a doser is used.

### **What should the top off res be balance to?**

When operated properly, top off should be balanced the same or slightly higher as the solution in the system. Traditionally hydro growers have been instructed to top off with 1/2 strength or pure water to avoid nutrient toxicity but because the UC runs best with 1/2 strength nutes there is less of a chance of salt build-up. Ideally the solution in the system should stay balanced even as the plants use the nutrient and water. As a rule of thumb if the nutrient EC/TDS rises as the solution is depleted you are likely running your levels too high to begin with. Conversely, if your EC/TDS drops it indicates you've started to low. Ultimately, as solution levels drop in the system the EC/TDS should stay stable, this is a good indicator that you're dialed in. This EC/TDS stability will translate into improved plant health and greater pH stability to boot.

### **What if I experience drift in my nutes?**

Correct it with your top off solutions. Example: system started at 500ppm but has crept to 625ppm as the solution level has decreased. That's a 25% increase, which can be easily offset by a top off res balanced @ 25% below the initial 500ppm. This results in a top off res balanced at 375ppm to compensate. Ideally solution strength should stay constant as the plants consume it. This is a good indicator that minerals & water are being used at equal proportions.

### **Does this help pH stability?**

Absolutely! Any upward or downward fluctuations in EC/PPM can have an effect on pH. By avoiding excess TDS, the solution is easier to keep stable. If any pH adjustments are needed they can most easily be altered by the top off input. Example pH @ 6.0 to start drifts to 6.5 over a 5 day period can easily be offset by making the top off res slightly more acidic so when top off solution enters system it gradually maintains proper pH levels as the plants access the nutrients. This will help avoid any potential nutrient lock outs caused by adjusting the pH with concentrated acid or bases. Observations and slight adjustments are the best way to dial your system in, when in doubt give CCH2O a call.

### **If pH adjusting is necessary is it a pain like in other modular systems?**

The UC exchanges no less than 5 times the entire system volume per hour. With this being said, getting the pH balanced is a lot less drama then it has been in the past. (Rule of thumb, if the pH is between 5.5-6.5 let it be. Nutrients in this pH range are abundantly available. At times dialing in your solution to the "perfect" pH can be more counterproductive then just letting it ride. If you are experiencing severe pH fluctuations (0.2-0.5 +/- a day) you might consider changing to a more pH stable nutrient.

### **What solution temperatures are optimal?**

The system operates well anywhere from 65-75 degrees F. We recommend maintaining a temperature between 68-72 degrees F. This is a happy medium between optimum dissolved oxygen capacity without getting to cold and slowing the plants metabolism. If necessary a chiller can be easily adapted to the return pump on the UC.

### **Besides high water temps what else can reduce dissolved oxygen levels in the system?**

Elevated levels of dissolved solids can displace D.O. as they compete for real estate in the nutrient solution. So cool, 1/2 strength nutes are a perfect environment for high D.O. levels

### **What D.O. levels should growers expect in the UC?**

We've tested on average +/- 9ppm of D.O. in solution. Water temps and quality will influence levels. As a point of reference Dr. Elaine Ingham recommends no less than 6ppm to brew actively aerated teas.

### **Do bio inoculants thrive in the UC?**

Given our increased levels of D.O. the UC does make a pretty good bio tea brewer, but... we do recommend very dilute amounts of inoculants to be added to the systems. Unlike a tea brewer, the solution in the UC is intended to be recirculated for prolonged periods of time. Most tea brewing cycles should conclude between 24-72 hours. Teas in hydro water culture systems can build up harmful bio films resulting in potential pathogen outbreaks. (If teas & inoculants are used we recommend more frequent nutrient change outs.)

### **What is the best nutrient additive for the UC?**

As with all hydro starting with pure water is paramount. Low EC/TDS, de-chlorinated water always works best. Low TDS in the parent water allows room for a well balanced nutrient concentrate to occupy the nutrient solution. The more balanced the nutrient to start, the better it will operate at low concentrations in solution and in turn the more usable it will be for your plants.

### **What strength nutes?**

Simple question, not so simple of an answer. Depending on environment, genetics, quality nutrient, etc. your responses nutritionally should vary. Generically speaking we recommend 1/2 strength of normal usage directions on the bottle. More importantly we recommend sticking to base nutrients only, especially if you're new to DWC. If your nutes are worth their salt (pun intended) you should be blown away by the results you get. Any top shelf base nutes will provide all your plants need to thrive.

### **What about nutrient schedules that change by week?**

Given we encourage less frequent nutrient change outs this does complicate things a bit. Best technique is to dilute any primary supplement into the top off reservoir. Any heavy additives...i.e. molasses, carbos, etc. can be introduced by hand directly to the root crown. Preferably avoiding run off into the solution below. This will help to avoid fouling the solution and hastening the need for a nutrient change out. And remember most supplements work great as foliar sprays.

**BLOOM BOOSTER TIP** -When following a nutrient schedule go 1/2 strength throughout, but increase to full strength in the second trimester (week 4-6) of bloom to ensure proper fruit and flower development.

### **How do you veg for the system?**

With our Quad Tops of course. You can transplant our 5.5" heavy duty net pots right into your blooming UC rig. Other systems that veg well for our system include the GH AeroFlo2, AH N.F.T., or transplant straight out of any aero clone. Veg times in the UC are notoriously quick so start your fruiting cycles early to avoid overgrown madness. No...seriously though.

### **What grow media works best in the net pots?**

Any non wicking inert grow media tends to work best. Expanded clay pellets, growstones, lava rock to name a few. When using a wicking media like rockwool be sure to adjust solution level to below contact with the R.W. We are working toward a zero grow media system but haven't solved the plant stability issue yet.

### **How much longer will nutrient stay viable vs. traditional Ebb n flow set ups?**

Time frames vary but typical change outs in E/F are about 7-10 days. In the UC change outs should be necessary no sooner then 21-28 days. Many variables influence this time frame, so adjust your time frame to best meet your needs. \*Change nutes once they destabilize or become murky.

### **If plants use nutrient so efficiently how are they conserved?**

Less frequent nutrient change outs, lower usage rates, less pH fluctuations (less pH adjusters needed) and the conservation of precious H2O. Just a few of the reasons we feel the UC is the system for ECO-HYDRO HEADS to hang their hats on. Huge yields, ease of use, short days to harvest... perfect for anybody in their right mind.

### **Do I need to disassemble to clean the UC?**

Disassembly is not necessary. A bottle brush, green pad, biogreen and some elbow grease is all you need. A shop vac helps a lot too.

### **What different configurations are available?**

The UC comes in several configurations...check the website [www.cch2o.com](http://www.cch2o.com) for all the configurations.

Simplify your grow and you may find yourself with more time. When used properly the UC will give you lots of extra time. You can't buy that in a bottle.