



INSTALLATION INSTRUCTIONS

IMPORTANT SAFEGUARDS

When using electrical equipment, basic safety precautions should always be followed including the following:

READ AND FOLLOW ALL SAFETY INSTRUCTIONS

- 1. DANGER - RISK OF SHOCK - DISCONNECT POWER BEFORE INSTALLATION**
DANGER - RISQUE DE CHOC - COUPER L'ALIMENTATION AVANT L'INSTALLATION
- 2. WARNING - Risk of fire or electric shock. LED Upgrade Kit installation requires knowledge of luminaire electrical systems. If not qualified, do not attempt installation. Product must be installed in accordance with NEC or your local electrical code. If you are not familiar with these codes and requirements, contact a qualified electrician.**
ATTENTION- Risque d'incendie ou de choc électrique. L'installation du kit upgrade LED exige la connaissance des systèmes électriques pour luminaires. Si non qualifié, ne tentez pas d'installation. Ce produit doit être installé conformément à NEC ou votre code électrique local. Si vous n'êtes pas familier avec ces codes et ces exigences, veuillez contacter un électricien qualifié.
- 3. WARNING - Risk of fire or electric shock. Luminaire wiring and electrical parts may be damaged when drilling for installation of the LED upgrade kit. Check for enclosed wiring and components.**
ATTENTION - Risque d'incendie ou de choc électrique. Câblage électriques peuvent être endommagés lors du perçage pour l'installation du kit upgrade LED. Vérifier les fils et composants.
- 4. WARNING - Risk of fire or electric shock. Check the existing wiring for damage before installing upgrade kit. Do not install if existing wires are damaged.**
ATTENTION- Risque d'incendie ou de choc électrique. Vérifiez si le câblage existant n'est pas endommagé avant l'installation du kit upgrade LED. Ne pas installer si des fils sont endommagés.
- 5. WARNING - To prevent wiring damage or abrasion, do not expose wires to the edge of sheet metal or any other sharp objects.**
ATTENTION - Pour éviter les dégâts de câblage par l'abrasion, ne pas mettre en contact les fils électriques avec des bords de tôle ou d'autres objets pointus.
- 6. WARNING - Risk of fire or electric shock. Install this kit only in the luminaires that have the construction features and dimensions shown in the photographs and/or drawings.**
ATTENTION - Risque d'incendie ou de choc électrique. Installez ce kit seulement dans les luminaires qui ont les caractéristiques de construction et les dimensions dans les photographies ou les dessins de la page suivante.
- 7. The retrofit assembly is accepted as a component of a luminaire where the suitability of the combination shall be determined by ul or authorities having jurisdiction**
Le montage rétracté est considéré comme le composant d'un système luminaire incandescent où l'adaptation à la structure doit être déterminée par le csa ou les autorités en vigueur.
- 8. Only the holes indicated in the photographs or drawings may be made or altered as a result of the kit installation. Do not leave any other holes open in a wiring enclosure or electrical component.**
Seulement les trous indiqués dans les photographies ou les dessins peuvent être faits ou altérés pour l'installation du kit upgrade LED. Ne laissez aucun trou ouvert dans le compartiment électrique.

SAVE THESE INSTRUCTIONS FOR FUTURE REFERENCE

NOTES:

- Upgrade Kit is for installation in a 1x4 or 2x4 luminaire with the following minimum dimensions:
 - 2-15/16" deep pan
 - 3" wide minimum wiring compartment
 - 43" minimum length to accommodate lightbars
 - Only ONE kit is to be installed per luminaire
- Consult your local authority regarding disposal or recycling of removed ballast and lamp.

LIST OF SUPPLIED COMPONENTS

Upgrade UR2 Kit contains the following parts:

- | | |
|----------------------|----------------------------------|
| (2) - LED lightbars | (8) - #6-20 Self Drilling Screws |
| (1) - Driver | (1) -#8-32 Driver Mounting screw |
| (6) - Mounting Clips | (1) - Relamping label |

Upgrade UR3 Kit contains the following parts:

- | | |
|-----------------------------------|----------------------------------|
| (3) - LED lightbars | (1) -#8-32 Driver Mounting screw |
| (1) - Driver | (1) - Relamping label |
| (9) - Mounting Clips | (1) - Extension Cable |
| (12) - #6-20 Self Drilling Screws | |

TO INSTALL



STEP 1:

Locate latches on the lens frame and release them allowing lens frame to swing open. Carefully let lens frame hang. See **Figure 1**.



STEP 2:

Remove existing linear fluorescent tubes and properly dispose of them. See **Figure 2**.



STEP 3:

To remove the wiring compartment, squeeze the sides in and pull down and set aside. See **Figure 3**.

STEP 4:

Locate the existing ballast and remove the screw holding the ballast to the housing. Properly dispose of the screw. See **Figure 3**.

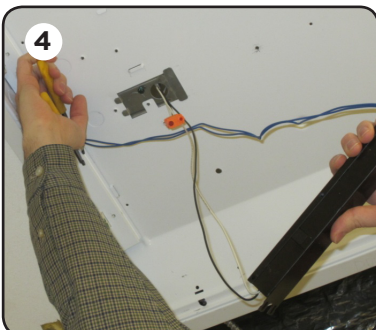

STEP 5:

To remove the ballast from housing, cut the leads from the ballast to the socket housing on both ends of the luminaire and cap socket leads. See **Figure 4 and 5**.

NOTE: When cutting leads, leave the smallest amount of wire attached to luminaire.

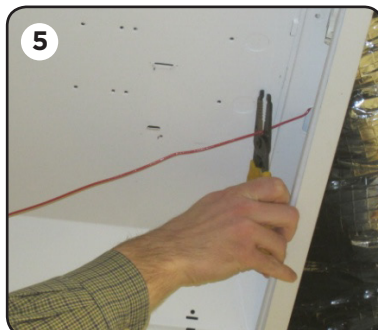

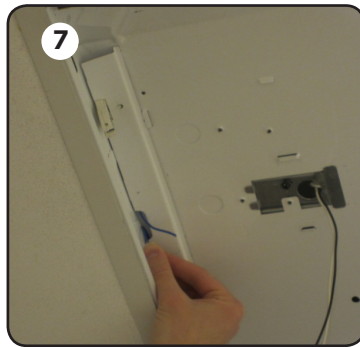
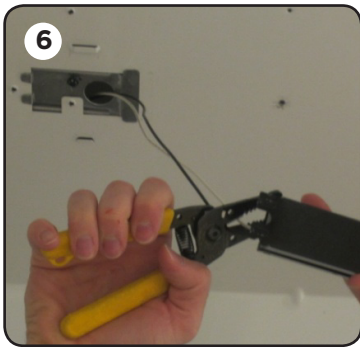

STEP 6:

Cut the leads from the ballast to the input power ensuring to leave as much length as possible for electrical connections. Remove ballast from housing and properly dispose of. See **Figure 6**.

STEP 7:

Push exposed socket leads back into socket housing on each side of the luminaire or cap any exposed accessible leads. See **Figure 7**.



STEP 8:

Prepare input power by stripping input power leads 1/4". See **Figure 8**.

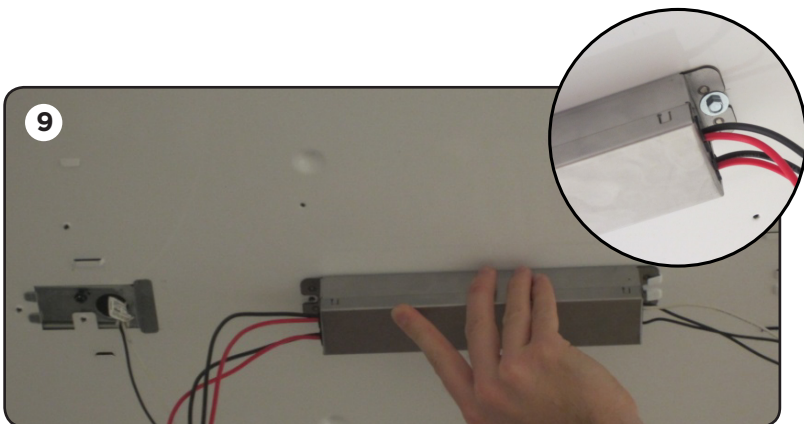

STEP 9:

Bring new driver into housing using mounting holes from old ballast and secure it using supplied #8-32 screw. Ensure that the existing luminaire housing is properly grounded to ensure proper driver grounding. See **Figure 9**.

NOTE: If housing has multiple locations for power supply, new driver can be secured in any of these locations.

STEP 10:

Make electrical connection per **"Electrical Connections"** section on page 5.

NOTE: Ensure that the driver is properly grounded to luminaire using supplied screw from Step 9.

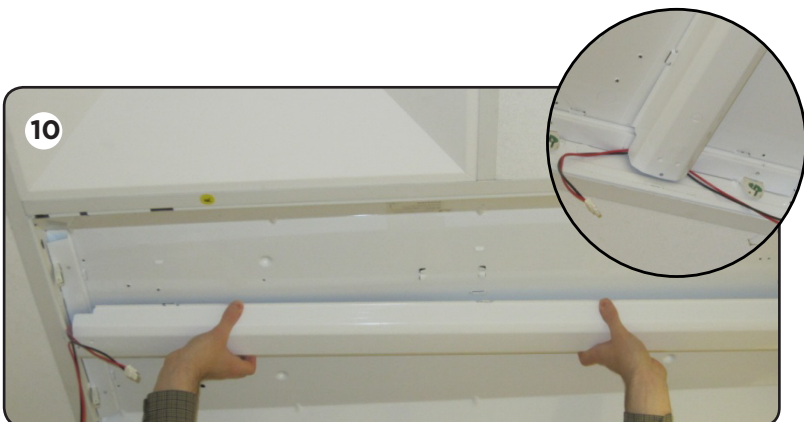

STEP 11:

Bring wiring compartment previously removed in Step 3 into the housing. Carefully tuck all leads and wire connectors into the wire compartment. Reattach wire compartment by snapping into place over driver insuring no wires are pinched. See **Figure 10**.

Figure 10.

NOTE: Route the driver outgoing leads through the wiring compartment allowing leads to be exposed through the end of the wiring compartment. See **Figure 10**.

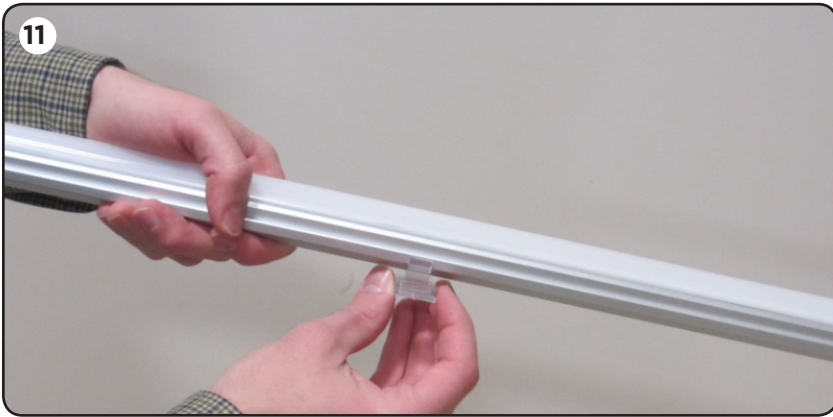

STEP 12:

Snap (3) supplied mounting clips onto each LED lightbar. See **Figure 11**.

STEP 13:

Bring LED lightbar into housing and reposition clips on LED lightbar as needed. For temporary placement of LED lightbar the clips have magnets located on the bottom of the clip. Repeat this step for each LED lightbar supplied in kit.

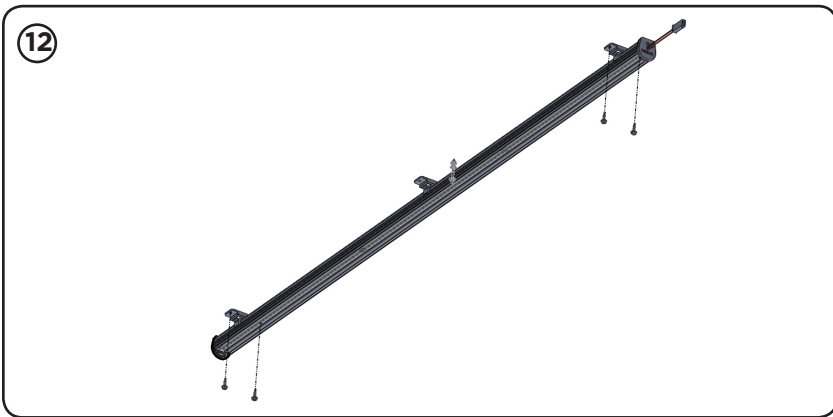

STEP 14:

Once all LED lightbars are in desired position permanently secure them to housing by inserting (2) supplied self tapping screws into each end of the LED lightbar. See **Figure 12**.

NOTE: The middle bracket on the LED lightbar DOES NOT need to be secured.

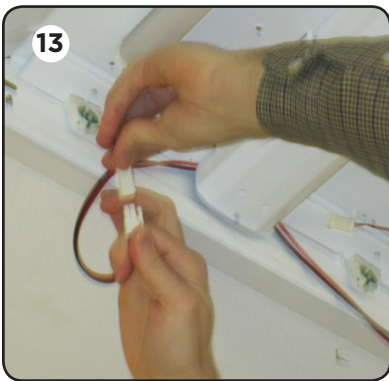

STEP 15:

Connect the power supply leads connector, that is exposed at the end of the wiring compartment with the LED lightbar connector. See **Figure 13**.

NOTE: For UR3 kits an extension cord needs to be applied to the lightbar connector farthest from the wiring compartment and the power supply leads at the end of the wiring compartment. See **Figure 14**.

NOTE: Place the relamp label, provided in the kit, on the lighting compartment. Make sure that the label is visible.

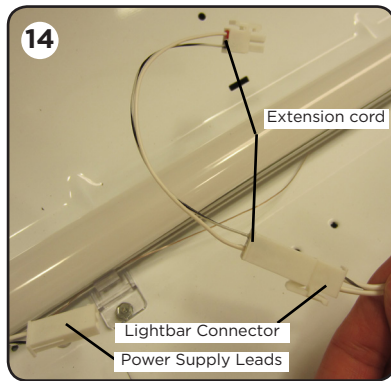

STEP 16:

Close the lens door and secure the latches.

ELECTRICAL CONNECTIONS

Make the following Electrical Connections:

- Connect the black fixture lead to the voltage supply Line position. S1 Hot 1 and S2 Hot 2.
- Connect the white fixture lead to the neutral supply position.
- For Step Dimming refer to the table.

Power Output	Position	
	S1	S2
100%	On	On
50%	On	Off
50%	Off	On
0%	Off	Off

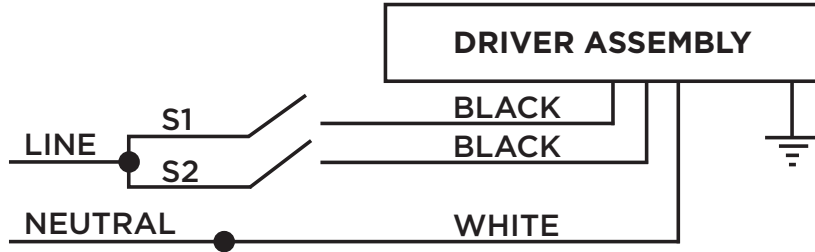

ELECTRICAL CONNECTIONS - 0-10V DIMMING (120-277VAC AND 347V MODELS)

STEP 1:

Connect power conduit and dimming conduit to access plates (and expanded J-Box if needed).

STEP 2:

Make the following Electrical Connections:

- Connect the black fixture lead to the voltage supply Line position, Hot.
- Connect the white fixture lead to the neutral supply position.
- Connect the green or green/yellow ground lead to the supply ground lead.
- If 0/1-10v Dimming is used, connect the violet lead to the supply positive dimming lead.
- If 0/1-10v Dimming is used, connect the gray lead to the supply negative dimming lead.

