

Model Number:

Approvals:

Type:

Job:

ONE AND TWO LAMP

6 and 12 Volt

ILLUMINATION

The Value Series Remote Emergency Head utilizes a lamp reflector system that can be adjusted 180° horizontally and vertically to direct light exactly where it is needed. Choice of tungsten or halogen high performance lamps between 6 and 20 watts. The polycarbonate diffuser hides the actual lamp system while maximizing the reflector efficiency.

HOUSING

Constructed of high impact thermoplastic. Backplate has matching knockouts for easy installation to junction boxes. Installation is further simplified with a snap together backplate and diffuser. Also available with a form-fitted gasket for outdoor applications.

WARRANTY

Any component that fails due to manufacturer's defect is guaranteed for 1 year. The warranty does not cover physical damage, abuse or acts of God.



VR1



VR2



The Value Series Remote Emergency Head blends seamlessly with existing interiors and can be remoted from any standard emergency lighting unit. It is designed to complement the Exitronix 6 volt VEX Series exit signs or 6 and 12 volt emergency lighting units.

DIMENSIONS

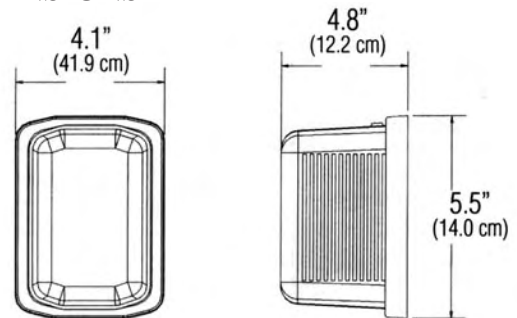

ORDERING INFORMATION

VR	VIT	W	D	
SERIES	LAMP WATTAGE/VOLTAGE	BACKPLATE COLOR	OPTIONS	
VR = One Lamp VR2 = Two Lamps	<p>6V, TUNGSTEN T-5 WEDGE BASE</p> <p>V0T = 4.6 Watt V1T = 6.0 Watt V2T = 7.0 Watt V3T = 9.0 Watt</p> <p>6V, HALOGEN T-2¼ WEDGE BASE</p> <p>V1H = 7.0 Watt V2H = 10 Watt V3H = 12 Watt</p>	<p>12V², TUNGSTEN T-5 WEDGE BASE</p> <p>V4T = 9 Watt V5T = 12 Watt V6T = 18 Watt</p> <p>12V², HALOGEN T-2¼ WEDGE BASE</p> <p>V4H = 12 Watt</p>	<p>W = White B = Black</p>	<p>D = Gasket for outdoor use¹</p>

2 LAMP HEADS

*6V, HALOGEN MR11 STYLE

V10H = 5.0 Watt

*only available with VR2

Specifications are subject to change without notice

Notes:

1. A form fitted gasket is supplied to be installed between the luminaire and junction box to protect against water entry. This product is not recommended for use in areas where high wind, or high pressure spray washdown could occur.
2. 12 volt remotes are available only in conjunction with 12 volt emergency lighting units and are not adaptable for use with exit signs.
3. Halogen 20 watt, 12VDC lamp is an MR16 style. The standard 20 watt MR16 lamp incorporates a (NSP-15) narrow spot, 15 degree beam pattern.

**6 Volt, 6 Watt
Value Series Tungsten
V1T**

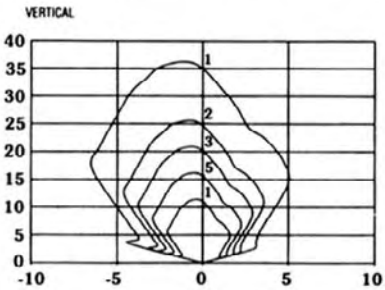
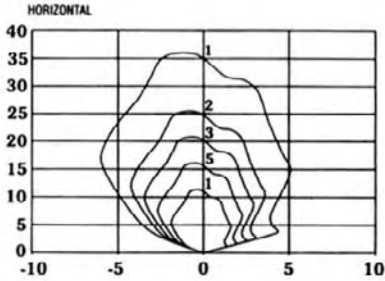

**6 Volt, 9 Watt
Value Series Tungsten
V3T**

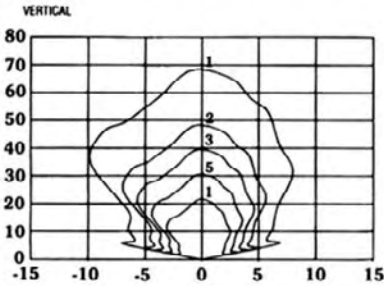
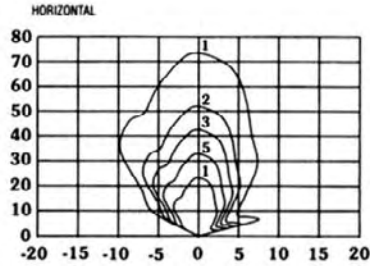

**6 Volt, 12 Watt
Value Series Halogen
V3H**

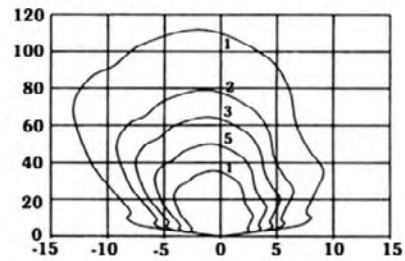
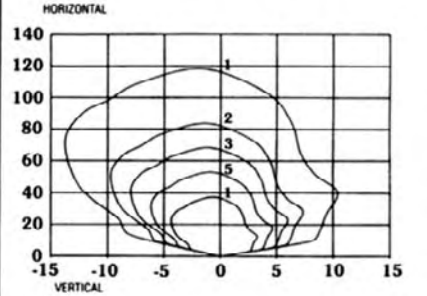

**12 Volt, 12 Watt
Value Series Halogen
V4H**

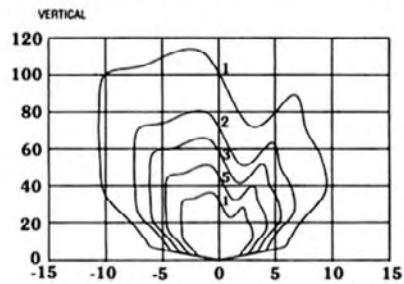
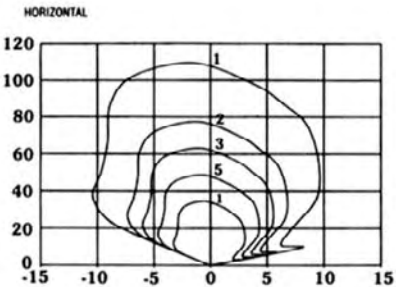

**12 Volt, 20 Watt
Value Series Halogen MR16
V5H**

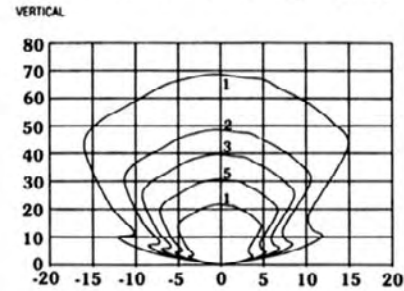
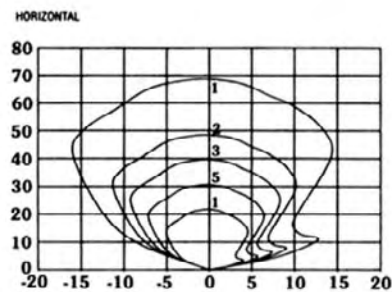

*** See Exitronix Redi-Lite
specification guide for
photometric performance of
lamp types not illustrated.**

YOUR LOCAL REPRESENTATIVE IS:

EXITRONIX™

A DIVISION OF THE

BARRON LIGHTING GROUP

1911 W. Parkside Lane • Phoenix, AZ 85027

(800) 533-3948 • Fax: (623) 580-8948

www.exitronix.com • www.barronltg.com