

DESCRIPTION

The Halo RL560 is a complete LED Baffle-Trim Module for 5" and 6" aperture recessed downlights; suitable for new construction, remodel and retrofit installation. The RL560 is cULus Listed for use with Halo and All-Pro, and is UL Classified for use with other compatible 5" and 6" housings. The RL560 with integral LED driver offers 120 volt dimming capability. The RL560 lens provides uniform illumination and wet location listing. The die-cast construction makes any housing AIR-TITE for added HVAC savings and code compliance.

Catalog #		Type
Project		
Comments		Date
Prepared by		

SPECIFICATION FEATURES

MECHANICAL

Module - Trim

- Module construction includes LED, heat sink, reflector, lens, baffle and trim ring
- Durable die-cast aluminum construction
- Regressed baffle
- Heat sink designed to conduct heat away from the LED keeping the junction temperatures below specified maximums, even when installed in insulated ceiling environments
- Halo matte white paint finish
- Halo satin nickel plated finish

Lens

- Regressed lens
- Impact-resistant polycarbonate
- Convex form for lamp-like appearance
- High lumen transmission
- Diffusing for even illumination

MOUNTING

Torsion Spring Brackets

- Pre-installed precision formed torsion spring brackets secure torsion springs and adjust to fit 5" or 6" compatible housings

5" & 6" Friction Blade Kit

- Precision formed friction blades included
- Provide alternative to torsion springs for retrofit in 5" and 6" housings without torsion spring mounting tabs.
- Friction blade design allows the RL560 to be installed in any position within the housing aperture (360 degrees).
- Replacement Kit: model RL56CLIP

Housing Compatibility

See Housing Compatibility

LED

- Color Temperature (CCT)[†]
Options: 2700K, 3000K, and 3500K
- Color Rendering Index (CRI)[†]
Options: 83 and 92
- Lumen maintenance:
L70 at 50,000 hours projected in accordance with IES TM-21

- LED is a chip on board design consisting of a multiple LED package with proximity phosphor coating to create one virtual white light source for a productive "cone of light"

ELECTRICAL

Power Connections

- LED connector is a non-screw base luminaire disconnect offering easy installation with the matching Halo 5" H550 Series and 6" H750 Series housings.
- LED Connector meets California Title-24 high-efficacy luminaire requirement for a non-screw base socket, and where required to qualify as a high-efficacy luminaire.
- The included E26 medium screw-base Edison adapter provides easy retrofit of incandescent housings (see Housing Compatibility).

Ground Connection

- Separate grounding cable included on the module for attachment to the housing during installation.

LED Driver

- Dimmable driver is a 120 Volt, high efficiency, electronic power supply providing DC power to the LED.
- Driver meets FCC EMI/RFI Consumer Level limits for use in residential and commercial installations.
- Driver features high power factor, low THD, and has integral thermal protection in the event of over temperature or internal failure.

Dimming

- The Halo RL560 LED module is designed for dimming capability to 10% in normal operation with standard 120V electronic low voltage, LED-Rated, and many incandescent dimmers. The RL560 has dimming capability to 5% with select dimmers with low end trim adjustment. (Consult dimmer manufacturer for dimmer

compatibility and details. Note, some dimmers require a neutral in the wallbox.

Warranty

Cooper Lighting provides a five year limited warranty on RL56 LED.

Compliance Labels

- UL/cUL Listed 1598 Luminaire (with listed Halo and All-Pro housings)
- UL Classified (with other housings - see Housing Compatibility)
- UL/cUL Listed for Damp Location
- UL/cUL Listed for Wet Location – Shower Applications
- IP56 Ingress Protection rated
- May be installed in housings in direct contact with air permeable insulation** and combustible material

Qualification

- ENERGY STAR[®] qualified residential and commercial*
- Can be used for State of California Title 24 high efficacy luminaire compliance*
- Can be used for International Energy Conservation Code (IECC) high efficacy luminaire compliance

IC and AIR-TITE[™]

Certified under ASTM-E283 and listed UL/cUL 1598 with compatible housings, may be used to meet insulated ceiling** and restricted air-flow requirements such as:

- Washington State Energy Code
- International Energy Conservation Code (IECC)
- New York State Energy Conservation Construction Code (NY-ECCC)
- State of California Title 24 "Recessed Luminaires in Insulated Ceilings."



*Qualified and compliant. Refer to ENERGY STAR[®] Qualified Products List and CEC (T24) Appliance Database for listings.

** Not for use with housings in direct contact with spray foam insulation.
† See ordering information table for available models.



RL560WH⁺
White



RL560SN⁺
Satin Nickel

80CRI
2700K, 3000K and 3500K

90CRI (white only)
3000K and 3500K

5-Inch / 6-Inch LED
Recessed Retrofit
Module-Trim

FOR USE IN
INSULATED CEILING
AND NON- INSULATED
CEILING RATED
HOUSINGS

HIGH EFFICACY LED
WITH INTEGRAL
DRIVER - DIMMABLE

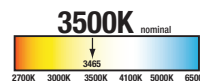
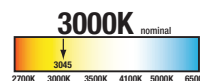
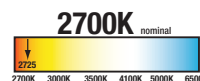

LIGHTING FACTS

RL560WH6827
2700K Source

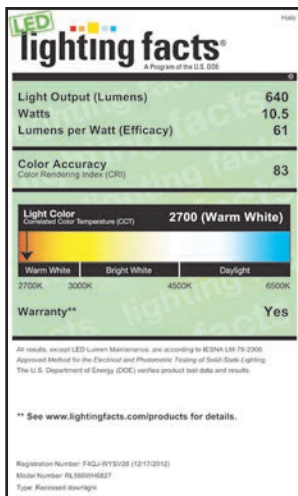

RL560WH6830
3000K Source

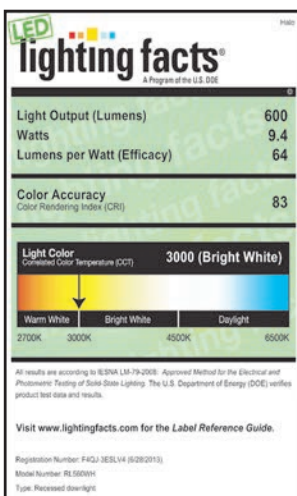

RL560WH6835
3500K Source

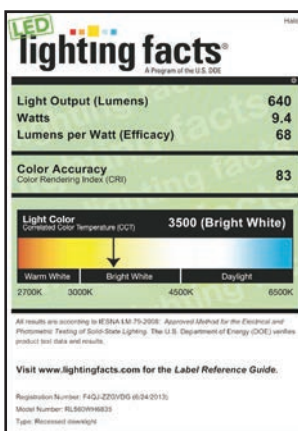

RL560WH6930
3000K Source

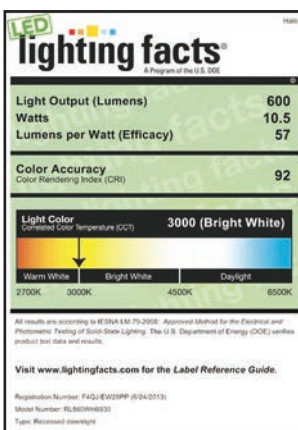

RL560WH6935
3500K Source

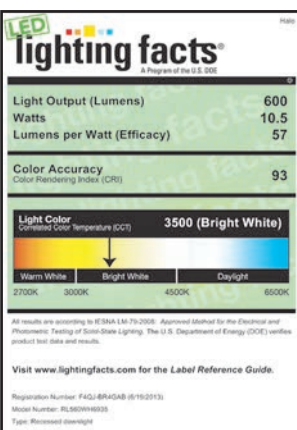

RL560SN6827
2700K Source

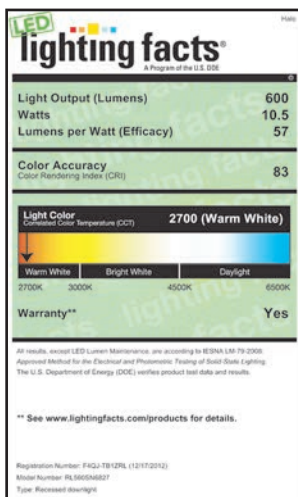

RL560SN6830
3000K Source

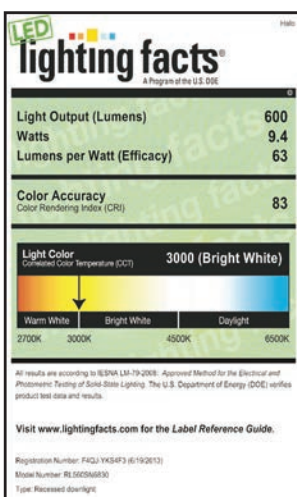

ENERGY DATA

RL560 Series Energy Data:

(Values at non-dimming line voltage)
Minimum Starting Temp: -30°C (-22°F)
EMI/RFI: FCC Title 47 CFR, Part 18, Class B (Consumer)
Sound Rating: Class A standards
Input Voltage: 120V
Power Factor: >0.90
Input Frequency: 60Hz
THD: <20%
Input Power: 10.5W (RL560WH6827, RL560SN6827, RL560WH6930, RL560WH6935)
Input Power: 9.4W (RL560WH6830, RL560SN6830, RL560WH6835)
Input Current: .15A
Maximum IC (Insulated Ceiling) Ambient Continuous Operating Temperature: 25°C (77°F)
Maximum Non-IC Ambient Continuous Operating Temperature 40°C (104°F)

DIMENSIONS

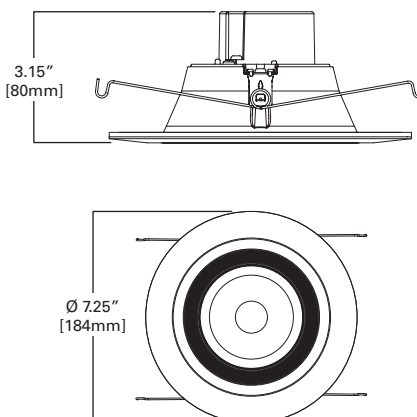

ORDERING INFORMATION

SAMPLE NUMBER: RL560WH6827

Complete unit includes a RL560 Baffle-Trim LED Module and a 5" and 6" compatible housing, ordered separately.

RL56 Series	Accessory (order separately)
<p>80 CRI RL560WH6827= 5"/6" Retrofit Baffle - Trim LED Module, 83CRI, 2700K, Matte White RL560SN6827= 5"/6" Retrofit Baffle - Trim LED Module, 83CRI, 2700K, Satin Nickel RL560WH6830= 5"/6" Retrofit Baffle - Trim LED Module, 83CRI, 3000K, Matte White RL560SN6830= 5"/6" Retrofit Baffle - Trim LED Module, 83CRI, 3000K, Satin Nickel RL560WH6835= 5"/6" Retrofit Baffle - Trim LED Module, 83CRI, 3500K, Matte White</p> <p>90 CRI RL560WH6930= 5"/6" Retrofit Baffle - Trim LED Module, 92CRI, 3000K, Matte White RL560WH6935= 5"/6" Retrofit Baffle - Trim LED Module, 92CRI, 3500K, Matte White</p>	<p>RL56CLIP=Replacement kit of 5" and 6" Friction Clips for retrofitting into an existing housing without torsion spring receiving brackets. (One set of clips included with the unit.) OT400P=Oversize Flat White Metal Trim Ring 6" I.D. x 9-1/4" O.D. (ring slips behind RL560 ring, in stepped configuration) OT403P=Oversize White Plastic Trim Ring 6" I.D. x 8" O.D. (ring slips behind RL560 ring, in stepped configuration) TRM690WH=Oversize Matte White Metal Trim Ring. Designed for RL560 ring to inset into oversize ring for an even (non-stepped) trim surface HE26LED=Replacement screw base adapter (one included with unit)</p>

HOUSINGS - Halo and All-Pro UL Listed Compatibility

Compatible Halo LED Housings with LED luminaire connector (high-efficacy compliant)

HALO	Recessed Can Size	Catalog Number	Description
	6"	5"	H550ICAT
H550RICAT			5" LED, Insulated Ceiling, AIR-TITE, Remodel Housing
6"		H750ICAT	6" LED, Insulated Ceiling, AIR-TITE, New Construction Housing
		H750RICAT	6" LED, Insulated Ceiling, AIR-TITE, Remodel Housing
		H750T	6" LED, Non-IC, AIR-TITE, New Construction Housing
		H750RINTD010	6" LED, Non-IC, AIR-TITE, Remodel International Housing, 0-10V DC Dimming
		H750TCP	6" LED, Non-IC, New Construction/Remodel Chicago Plenum Housing
		H2750ICAT	6" LED, Shallow, Insulated Ceiling, AIR-TITE, New Construction Housing

Compatible Halo Incandescent E26 Screwbase Housings

HALO	Recessed Can Size	Catalog Number	Description
	6"	5"	H5ICAT
H5RICAT			5" Insulated Ceiling, AIR-TITE Remodel Housing
H5T			5" Non-IC, New Construction Housing
H5RT			5" Non-IC, Remodel Housing
H5TM			5" Non-IC, New Construction Housing (metric version - Canada)
H25ICAT			5" Shallow, Insulated Ceiling, AIR-TITE New Construction
6"		H7ICAT	6" Insulated Ceiling, AIR-TITE New Construction Housing
		H7RICAT	6" Insulated Ceiling, AIR-TITE Remodel Housing
		H7ICT	6" Insulated Ceiling, New Construction Housing
		H7RICT	6" Insulated Ceiling, Remodel Housing
		H7ICATNB	6" Insulated Ceiling, AIR-TITE New Construction Housing, No Socket Bracket
		H7ICTNB	6" Insulated Ceiling, New Construction Housing, No Socket Bracket
		H7T	6" Non-IC, New Construction Housing
		H7RT	6" Non-IC, Remodel Housing
		H7TNB	6" Non-IC, New Construction Housing, No Socket Bracket
		H7TCP	6" Non-IC, Chicago Plenum, New Construction/Remodel Housing
		H7UICAT	6" Insulated Ceiling, Universal New Construction Housing
		H7UICAT	6" Insulated Ceiling, Universal, AIR-TITE, New Construction Housing
		H27ICAT	6" Shallow, Insulated Ceiling, AIR-TITE New Construction Housing
		H27RICAT	6" Shallow, Insulated Ceiling, AIR-TITE Remodel Housing
H27ICT	6" Shallow, Insulated Ceiling, New Construction Housing		
H27RICT	6" Shallow, Insulated Ceiling, Remodel Housing		
H27T	6" Shallow, Non-IC, New Construction Housing		
H27RT	6" Shallow, Non-IC, Remodel Housing		

HOUSINGS - Halo and All-Pro UL Listed Compatibility (continued)

Halo LED Retrofit Enclosures

HALO	6"	ML7BXRFK	6" Retrofit Enclosure, Non-IC, BX Whip
		ML7E26RFB	6" Retrofit Enclosure, Non-IC, E26 Screw base Interface

Compatible All-Pro Incandescent E26 Screwbase Housings

	Recessed Can Size	Catalog Number	Description
All-Pro	5"	EI500AT	5" Insulated Ceiling, AIR-TITE New Construction Housing
		EI500RAT	5" Insulated Ceiling, AIR-TITE Remodel Housing
		ET500	5" Non-IC, New Construction Housing
		ET500R	5" Non-IC, Remodel Housing
	6"	EI700AT	6" Insulated Ceiling, AIR-TITE New Construction Housing
		EI700RAT	6" Insulated Ceiling, AIR-TITE Remodel Housing
		EI700	6" Insulated Ceiling, New Construction Housing
		EI700R	6" Insulated Ceiling, Remodel Housing
		EI700ATNB	6" Insulated Ceiling, AIR-TITE New Construction Housing, No Socket Bracket
		EI700NB	6" Insulated Ceiling, New Construction Housing, No Socket Bracket
		EI700U	6" Insulated Ceiling, Universal New Construction Housing
		EI700UAT	6" Insulated Ceiling, Universal, AIR-TITE, New Construction Housing
		ET700	6" Non-IC, New Construction Housing
		ET700R	6" Non-IC, Remodel Housing
		EI2700AT	6" Shallow, Insulated Ceiling, AIR-TITE New Construction Housing
		EI2700	6" Shallow, Insulated Ceiling, New Construction Housing
		EI2700R	6" Shallow, Insulated Ceiling, AIR-TITE Remodel Housing
		ET2700	6" Shallow, Non-IC, New Construction Housing
		ET2700R	6" Shallow, Non-IC, Remodel Housing

HOUSINGS - UL Classified for retrofit compatibility

RL560 is UL Classified for retrofit in the following 5" and 6" recessed housings:

Juno®	IC22, IC22R, IC22W, IC22S, IC23, IC23W, IC21, IC21R, IC2, TC2, TC2R, IC20, IC20R, IC25, IC25R, IC25W, IC25S, TC20, TC20R
Capri Lighting	CR1, PR1, QL1, R9ASIC, R5*
Lightolier®	1104ICS*, 1104ICR*, 1104SIC*, 1104SICR*, 1004ICS*, 1004ICR*, 1004SIC*, 1004SICR* 1104ICX - Requires installation of ML7RAB retrofit adapter band accessory (not included).
Progress® Lighting	P87-AT*, P86TG
Lithonia Lighting®	L7X, L7XP
Thomas® Lighting	PS1, R9ASIC/PS9RM
Prescolite®	IBXS
Commercial Electric™	C7ICA (H3), H18
Elco Lighting®	(HL7ICA) EL7ICA

*Requires replacement of torsion springs with included friction clips (accessory replacement kit: RL56CLIP).

Juno®, Capri Lighting, Lightolier®, Lithonia Lighting®, Thomas® Lighting, Elco Lighting®, Progress® Lighting, Prescolite® and Commercial Electric™ and their product brand names, where identified above, are tradenames or trademarks of each respective company and Cooper makes no representations on these trademarks.