



PAR30

Dimmable Recessed Light

Leapfrog Lighting's Energy Star certified PAR30 LED lamp provides industry-leading light quality, output power, and efficacy as a result of our patented intelligent optics lens and high-efficiency, high-reliability LED source and driver electronics.

Features

- Innovative anti-glare lens technology
- Energy Star certified (3000K)
- Available in a variety of CCTs and beam angles
- Top performing light output and efficacy
- High Power Factor
- Compatible with most ANSI/NEMA approved dimmers designed for LED use
- UL certified
- Comprehensive five-year warranty
- Tested per IESNA LM-79-2008



Contact

Head Office
400 March Road
Ottawa ON Canada
K2K 3H4
(613) 270-7879

North America (toll free):
1-800-396-9109

sales@leapfroglighting.com
www.leapfroglighting.com

LIGHT QUALITY

Evenly distributed, glare-free light with gentle roll-off at edges

APPLICATIONS

Indoor and unexposed outdoor down-lighting applications

LIFE EXPECTANCY

40,000 hours

PERFORMANCE

Dimmable, high efficacy (lm/W), single light source

COLOR

Ultra-consistent color temperature control critical to multi-lamp applications, with high CRI and pleasing CCT options.

SPECIFICATIONS

CCT ¹	CRI ²	BEAM	LM	W	LM/W	PART
2700K	82	20°	950	12.7	75	1001-P30LC-2703
	82	38°	950	12.7	75	1001-P30LC-2701
	82	60°	950	12.7	75	1001-P30LC-2702
3000K	82	20°	950	12.7	75	1001-P30LC-E26-3003
	82	38°	950	12.7	75	1001-P30LC-E26-3001
	82	60°	950	12.7	75	1001-P30LC-E26-3002
5000K	82	20°	1000	12.5	80	1001-P30LC-5003
	82	38°	1000	12.5	80	1001-P30LC-5001
	82	60°	1000	12.5	80	1001-P30LC-5002

1. Tolerances as per ANSI C78.377-2008 Nominal CCT categories
 2. CRI refers to the "General CRI" described as Ra in CIE 13.3
 3. Lifetime as defined by IESNA LM-80
 4. Compatible with ANSI C78.21-2011 dimensional requirements
 5. Duv values and tolerances as per ANSI C78.377-2008 Nominal CCT, Table 1, page 8

GENERAL

Min. lifetime ³	40,000 hours
Base type	E26/E27
Weight	14.4 oz.
Dimensions ⁴	PAR30L

ELECTRICAL

Voltage, nominal	120 VAC
Power factor	> 0.95
Dimming range	Flicker free down to 10% light output

OPTICAL

Duv ⁵	< 0.006
------------------	---------

DIMENSIONS

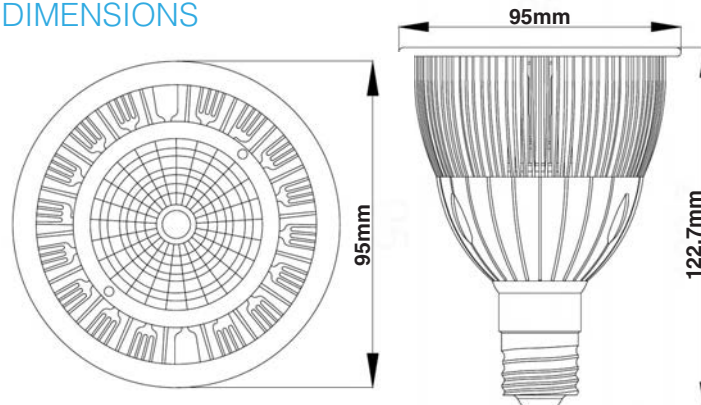

BASE TYPE

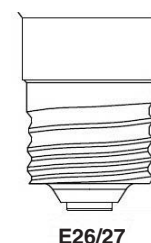

PAR30 DIMMER COMPATIBILITY (North America)

COOPER	LEGRAND	LEVITON	LUTRON
Aspire 9570 120V - 60Hz - 300W 9573 120V - 60Hz - 300W	Harmony DCL453PTC 120V - 60Hz - 450W	RPIo6-1L/RPIo6-1o 120V - 60Hz - 600W	Ariadni AYCL-153PH 120V - 60Hz - 600W TGCL-153PH 120V - 60Hz - 600W
Devine DEL06P 120V - 60Hz - 300W		S-600PH-WH-CSA 120V - 60Hz - 600W	Cradenza TT300 120V - 60Hz - 300W
Devione DLC03P 120V - 60Hz - 300W		6631-I 120V - 60Hz - 600W	Diva DVCL-153P* 120V - 60Hz - 600W
Skype SEL06P 120V - 60Hz - 300W SLC03P 120V - 60Hz - 300W			Lumea LGCL-153PLH 120V - 60Hz - 600W
			Maestro MACL-153M* 120V - 60Hz - 600W
			Skylark CTCL-153P* 120V - 60Hz - 600W

POLAR INTENSITY DIAGRAMS

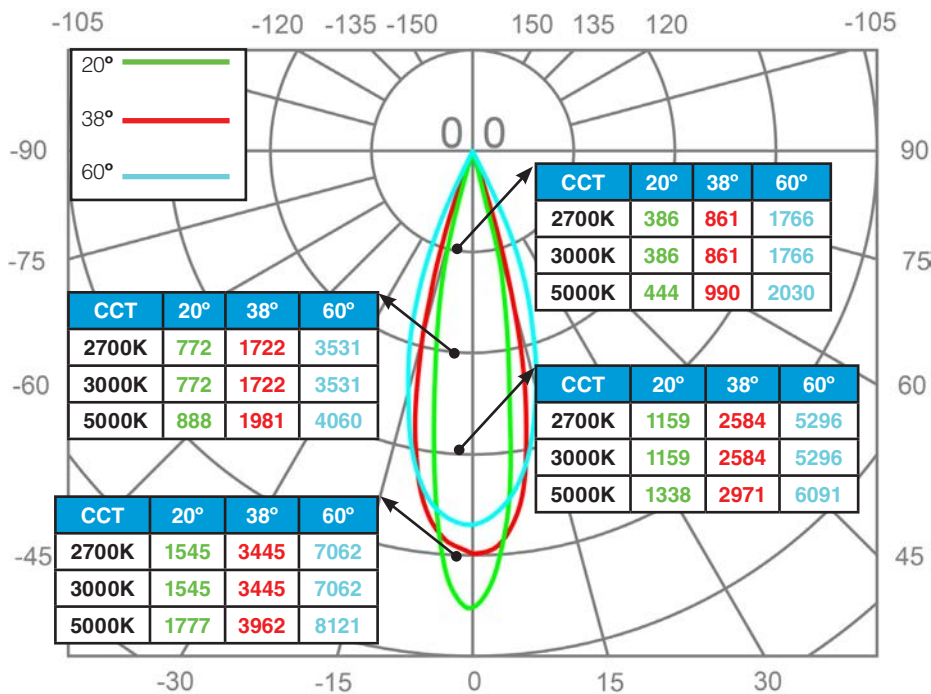

APPLICATION NOTES

Not for use in exposed outdoor down-lighting applications
 Ambient temperature within -20 to +45 °C

SAFETY NOTES

Warning: Risk of electric shock
 Do not disassemble (no user serviceable parts)
 Turn off power before inspection, installation or removal.

SPECTRAL POWER DISTRIBUTION

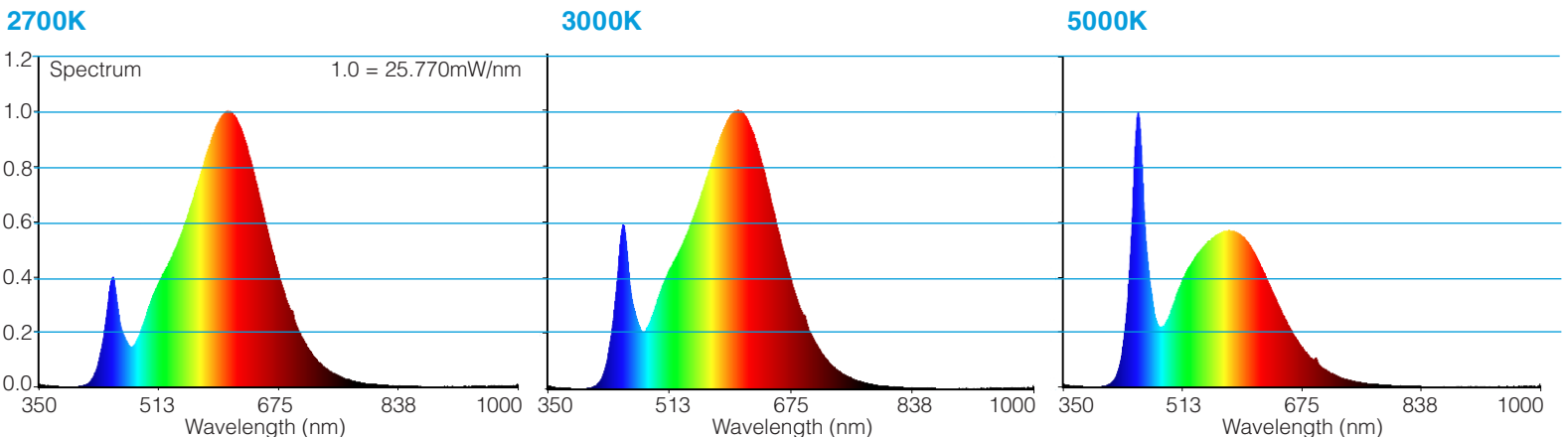

BEAM ANGLES

2700K

20 degrees

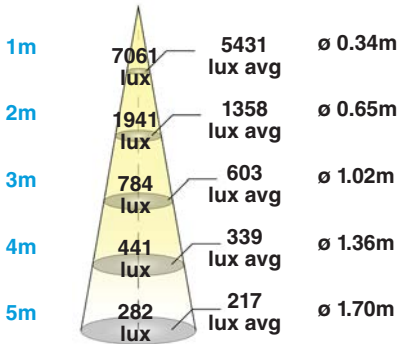

38 degrees

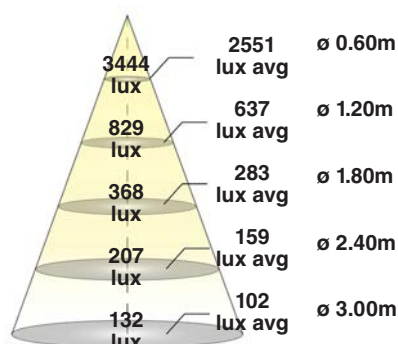

60 degrees

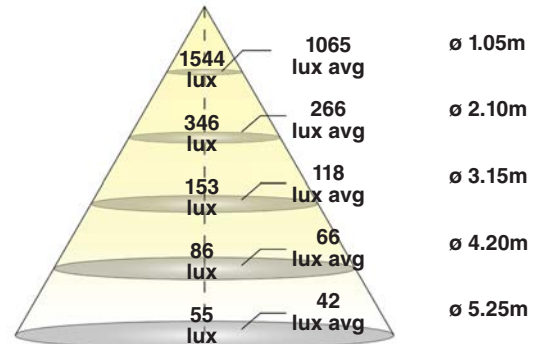

3000K

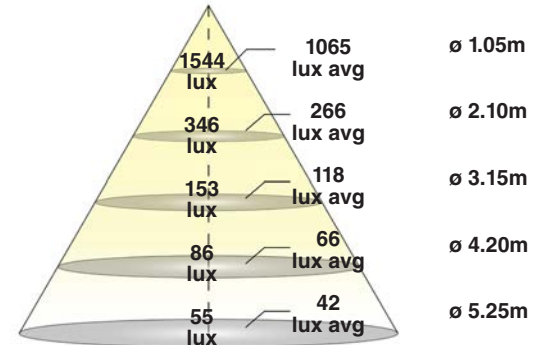
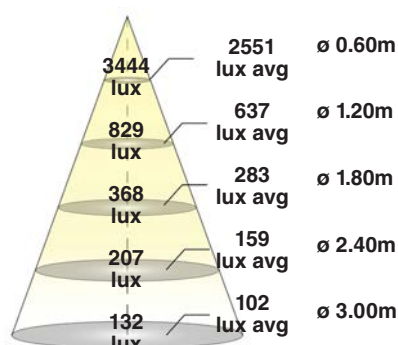
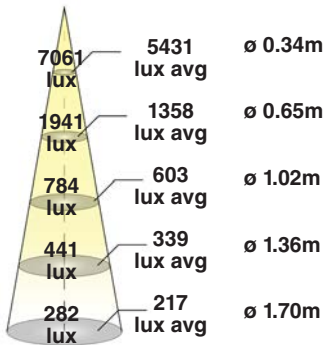

5000K

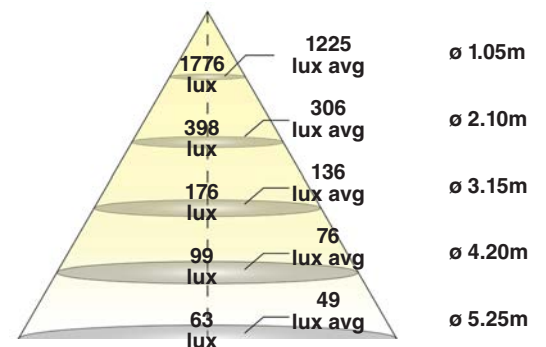
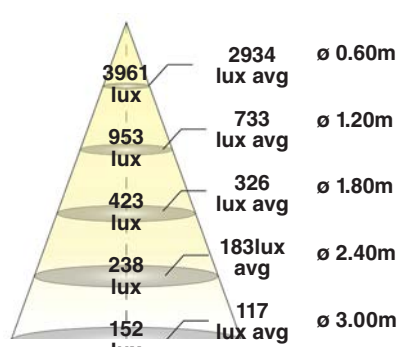
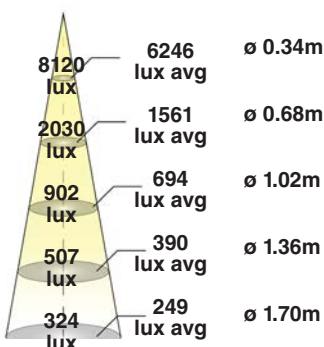

WARRANTY

If you're not satisfied with this lamp within 3 months, we will refund the purchase price. If the lamp fails to meet our specifications during the first 60 months, we'll replace it.

For additional warranty information, please refer to <http://www.leapfroglighting.com/resources/>.

