

LED-8033 Post Top / Site / Wall Pack

38w = 150W
LED MH / HPS

SKU No. (USA)
LED-8033E30
LED-8033E42
LED-8033E57

SKU No. Canada
LED-8033E30C 38W, 3000K
LED-8033E42C 38W, 4200K
LED-8033E57C 38W, 5700K

Description:

LED retrofit design to replace MH and HPS lamps up to 150w. Fully encapsulated, 38 watt LED with E26 Edison base. Compact size and 360° LED placement allows suitable for fully enclosed post top, shoe box and other typical HID fixtures giving full illumination.

- 38W power consumption
- Replaces up to a 150W HID
- 360° Illumination with "Up mounted LED's"
- 120-277VAC, Non-Dimmable (USA)
- 120-347VAC, Non-Dimmable (Canada)
- Available in 3000K, 4200K, and 5700K CCT
- >80 CRI
- 50,000 hr. rated L70 LED life
- Operating temp: -40°F - 122°F
- Double Insulated
- UL Classified Damp (US & CA)
- 5 Year warranty

Top Mounted LED's!

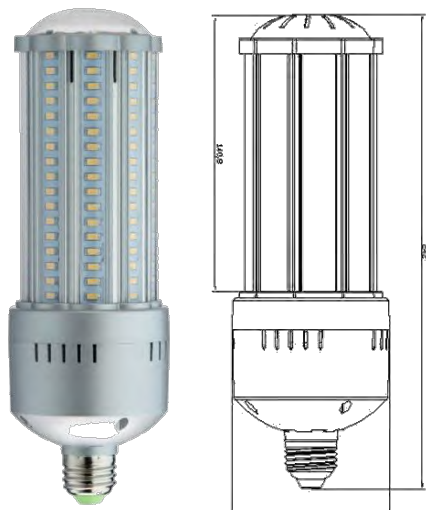

Applications:

LED Post top / Site / Area LED for HID retrofit lamps lower energy costs, bulb and ballast replacement costs and also can greatly reduce costly equipment rental when re-lamping HID lamps on and off cycle. LED for HID retrofits will also eliminate lamp disposal issues due to the mercury content in many HID lamps.

- Outdoor area lighting
- Bollard / Post Top
- Wall Pack
- Cold display
- Security Lighting

Packaging: 9/Master Carton

Unit : 4.7" x 4.7" x 8.9"
 Master: 14.8" x 14.8" x 9.5"

Installation Notes:

- When installing LED-8000 series retrofit lamps within HID fixtures, ballast must be bypassed when present.
- 8000 series retrofits are UL damp rated, sealing the fixtures after installation will deliver best results.
- Installing surge/lightning protectors is highly recommended and helps to eliminate premature driver failure caused by surges and other power fluctuations.

Technical Specifications

Bulb Type	HID Retrofit	Mounting	E26
Bulb Material	Aluminum/ Polycarbonate	LEDs:	153 Samsung/ Mason #5630 LED's
Power Consumption	38 watts	Beam Angle	360 °
Lumens	3000K: 3600 Lm 4200K: 3800 Lm 5700K: 3800 Lm	Dimmable	No
Efficacy	85 - 93 Lumens per watt	Replaces	Up to 150W HID
Rated LED Life	Up to 50,000 Hrs.	CCT	3000K 4200K 5700K
Power Factor:	>99	CRI:	> 80
IR / UV	None	Mercury/ Lead Content	None
Warranty	5 year Limited	Dimensions	9.52" X 3.15"

Note: All specification information falls within a ± 2% range and is subject to change without notice.

NOTE: Light Efficient Design is providing this information to the general public. Please note that all products contained herein are trademarked, copyrighted, and/or have patents pending. Any use of these designs is strictly prohibited without prior written consent. Light Efficient Design protects its proprietary information vigorously in the courts of the United States of America.



188 S Northwest Highway • Cary, IL 60013
(847) 380-3540 • FAX: (847) 380-3542
www.led-llc.com