

**PRODUCT SPECIFICATIONS****LEVITON®**

# vizia +<sup>®</sup>

## Commercial Grade Lighting Controls Collection



VPT24-1P

VPI06-1L

VPM10-1L

VPE06-1L

VP00R-10

VPS15

**KEY PRODUCT FEATURES**

- Superior versatility provides six product options in each box:
  - 3 changeable face plates
  - Single pole or 3-way
- Efficient construction with consistent form factor, excellent ergonomic traits and precision feel
- Digital circuitry provides aesthetically pleasing soft ON and fade OFF
- Innovative contoured geometry offers an exclusive aesthetic design
- High gloss finish complements any décor
- Green LED serves as locator light
- Complements Vizia RF +<sup>®</sup> lighting controls and switches
- Compatible with Decora Plus™ screwless wallplates
- Remotes available for multi-location control
- Meets all applicable UL, CSA and FCC requirements
- Five-Year Limited Warranty











**STANDARD FEATURES**

- Universal design
- Crisp actuation, minimal travel



**Leviton Mfg. Co., Inc.**

201 North Service Road, Melville, NY 11747-3138 Tech Line: 1-800-824-3005 Fax: 1-800-832-9538 [www.leviton.com](http://www.leviton.com)  
 © 2009 Leviton Manufacturing Co., Inc. All rights reserved. Subject to change without notice.





**DIMMERS AND FAN SPEED CONTROL**    
For Single Pole, 3-Way or More Applications

| Description   | Rating<br>(For Multi-gang Installation<br>see Derating Chart)   | Cat. No. |
|---|---|----------|
|  Incandescent Dimmer with LED Locator and Brightness Display                                   | 600W-120VAC   | VPI06-1L |
|  Magnetic Low Voltage Dimmer with LED Locator and Brightness Display                           | 600VA-120VAC  | VPM06-1L |
|  Incandescent/Magnetic Low Voltage Dimmer with LED Locator and Brightness Display              | 1000W-120VAC Incandescent<br>1000VA-120VAC Magnetic Low Voltage | VPM10-1L |
|  Electronic Low Voltage Dimmer with LED Locator and Brightness Display                        | 400W-120VAC   | VPE04-1L |
|  Electronic Low Voltage Dimmer with LED Locator and Brightness Display                       | 600W-120VAC   | VPE06-1L |
|  Mark 10® Powerline or Tu-Wire® Fluorescent Dimmer with LED Locator and Brightness Display   | 1000VA- 120VAC  | VPX10-1L |
|  Mark 10® Powerline Fluorescent Dimmer with LED Locator and Brightness Display               | 1200VA-277VAC   | VPX12-7L |
|  Hi-lume® or Eco-10® (Eco-Series) Fluorescent Dimmer with LED Locator and Brightness Display | 8A-120VAC   | VPH08-1L |
|  Hi-lume® or Eco-10® (Eco-Series) Fluorescent Dimmer with LED Locator and Brightness Display | 6A-277VAC   | VPH06-7L |
|  Quiet Fan Speed Control with LED Locator and Fan Speed Display                              | 1.5A-120VAC   | VPF01-1L |

**SWITCH AND TIMER SWITCH**    
For Single Pole, 3-Way or More Applications

| Description   | Rating     | Cat. No. |
|---|------------|----------|
|  Electronic Switch with LED Locator   | 15A-120VAC | VPS15-1L |
|  Electronic 24 Hour Timer Switch with Astronomical clock, Backlit LCD and LED Locator | 15A-120VAC | VPT24-1P |

**REMOTES**    
For Multi-location Control

| Description   | Rating                   | Cat. No. |
|---|--------------------------|----------|
|  Matching Remote Dimmer to 120VAC Dimmers/Fan Speed Control for 3-way or up to 5 location applications, with LED Locator and Brightness/Fan Speed Display | 120VAC<br>No load rating | VP00R-1L |
|  Matching Remote Dimmer to 277VAC Dimmers for 3-way or up to 5 location applications, with LED Locator and Brightness Display                             | 277VAC<br>No load rating | VP00R-7L |
|  Coordinating Remote Dimmer to 120VAC Dimmers/Fan Speed Control for 3-way or up to 10 location applications (No LEDs)                                     | 120VAC<br>No load rating | VP00R-10 |
|  Matching Remote Switch for Electronic Switch or 24 Hour Timer for 3-way or up to 5 location applications, with LED Locator                               | 120VAC<br>No load rating | VP0SR-1L |
|  Coordinating Remote Switch for Electronic Switch or 24 Hour Timer for 3-way or up to 10 location applications (No LED)                                   | 120VAC<br>No load rating | VP0SR-10 |

**Leviton Mfg. Co., Inc.**

201 North Service Road, Melville, NY 11747-3138 Tech Line: 1-800-824-3005 Fax: 1-800-832-9538 www.leviton.com  
© 2009 Leviton Manufacturing Co., Inc. All rights reserved. Subject to change without notice.

**DERATING/MAXIMUM CAPACITY**

In multi-gang applications derating is required in accordance with the following charts. Many controls have side sections and fin removal is required (consult instruction sheets for further details).

**VPI06 Incandescent (Minimum load: 40W)**

| Gang      | Maximum Wattage |
|-----------|-----------------|
| 1         | 600W            |
| 2         | 500W            |
| 3 or more | 400W            |

**VPM06 Magnetic Low Voltage (Minimum load: 40VA)**

| Gang      | Maximum VA | Maximum Bulb Wattage with 75% efficient transformer |
|-----------|------------|---|
| 1         | 600VA      | 450W  |
| 2         | 500VA      | 375W  |
| 3 or more | 400VA      | 300W  |

**VPM10 Incandescent/Magnetic Low Voltage (Minimum load: 40W/VA)**

| Gang      | Incandescent Maximum Wattage | Magnetic Low Voltage Maximum VA | Magnetic Low Voltage Maximum Bulb Wattage with 80% efficient transformer |
|-----------|------------------------------|---------------------------------|--|
| 1         | 1000W                        | 1000VA                          | 800W   |
| 2         | 800W                         | 800VA                           | 640W   |
| 3 or more | 650W                         | 650VA                           | 520W   |

**VPE04 Electronic Low Voltage**

| Gang      | Maximum Wattage |
|-----------|-----------------|
| 1         | 400W            |
| 2         | 350W            |
| 3 or more | 250W            |

**VPE06 Electronic Low Voltage**

| Gang      | Maximum Wattage |
|-----------|-----------------|
| 1         | 600W            |
| 2         | 500W            |
| 3 or more | 400W            |

**VPX10 Mark 10® Powerline or Tu-Wire® Fluorescent**

| Gang      | Maximum VA |
|-----------|------------|
| 1         | 1000VA     |
| 2         | 800VA      |
| 3 or more | 650VA      |

**VPX12 Mark 10® Powerline Fluorescent**

|             |                      |
|-------------|----------------------|
| 1200VA 4.3A | No derating required |
|-------------|----------------------|

**VPH08 Hi-lume® or Eco-10® (Eco-Series) Fluorescent Dimmer**

|    |                      |
|----|----------------------|
| 8A | No derating required |
|----|----------------------|

**VPH06 Hi-lume® or Eco-10® (Eco-Series) Fluorescent Dimmer**

|    |                      |
|----|----------------------|
| 6A | No derating required |
|----|----------------------|

**VPF01 Quiet Fan Speed Control**

|      |                      |
|------|----------------------|
| 1.5A | No derating required |
|------|----------------------|

**VPT24 24 Hour Timer Switch**

|     |                      |
|-----|----------------------|
| 15A | No derating required |
|-----|----------------------|

**Leviton Mfg. Co., Inc.**

201 North Service Road, Melville, NY 11747-3138 Tech Line: 1-800-824-3005 Fax: 1-800-832-9538 www.leviton.com  
© 2009 Leviton Manufacturing Co., Inc. All rights reserved. Subject to change without notice.

## WIRING DIAGRAMS

### Diagram 1

Single pole wiring for incandescent or magnetic low voltage dimmer.

#### Dimmers

VPI06  
VPM06  
VPM10

#### NOTES:

- 1) VPI06 and VPM06 have screw terminals, VPM10 has leads
- 2) Red and Black leads (or terminals) are interchangeable

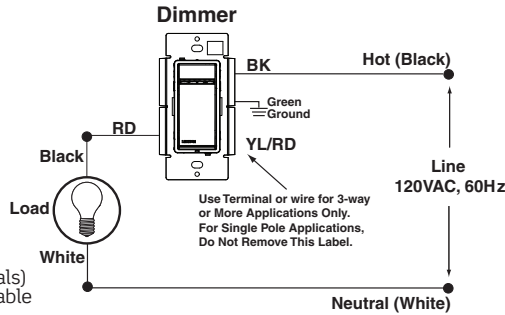

### Diagram 2

Single pole wiring for electronic low voltage dimmers, Mark 10® Powerline dimmers, fan speed control, switch, or timer switch.

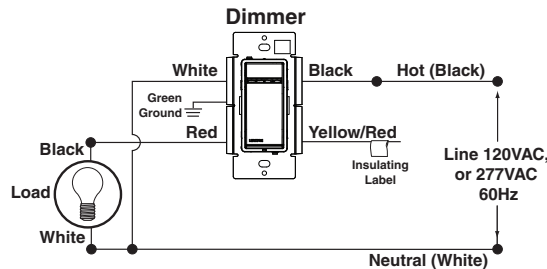

#### Dimmers

VPE04  
VPE06  
VPX10  
VPX12-7L

#### NOTES:

- 1) VPS15 has screw terminals, VPE04, VPE06, VPX10, VPF01, VPX12-7L and VPT24 have leads

#### Fan Speed Control

VPF01

#### Switch

VPS15  
VPT24

### Diagram 3

3-way wiring for incandescent or magnetic low voltage dimmers with coordinating remote.

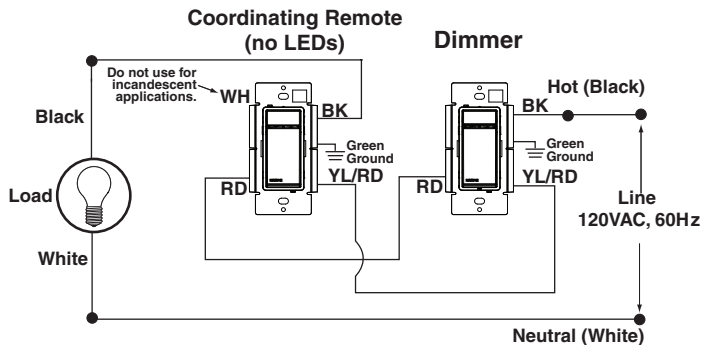

#### Dimmers

VPI06  
VPM06  
VPM10

#### NOTES:

- 1) VPI06, VPM06 and VP00R-10 have screw terminals, VPM10 has leads
- 2) Black connections are interchangeable (see Diagram 4)
- 3) Silver terminal on coordinating remote is unused

#### Coordinating Dimmer Remote

VP00R-10  
Coordinating Switch Remote  
VPOSR-10

### Diagram 4

Alternate 3-way wiring for incandescent or magnetic low voltage dimmer with coordinating remote.

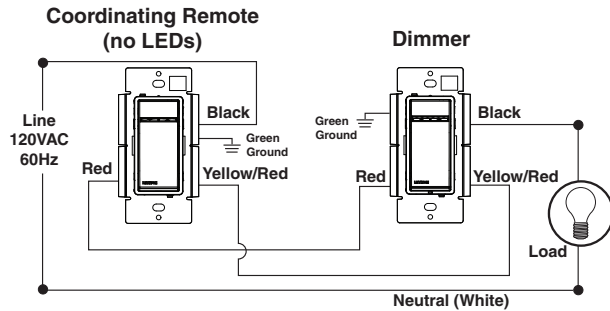

#### Dimmers

VPI06, VPM06, VPM10

#### Coordinating Dimmer Remote

VP00R-10

#### Coordinating Switch Remote

VPOSR-10

#### NOTES:

- 1) VPI06, VPM06 and VP00R-10 have screw terminals, VPM10 has leads
- 2) Black connections are interchangeable (see Diagram 3)
- 3) Silver terminal on coordinating remote is unused

### Diagram 5

3-way wiring for electronic low voltage dimmer, Mark 10® Powerline dimmer, fan speed control, switch, or timer switch with coordinating remote.

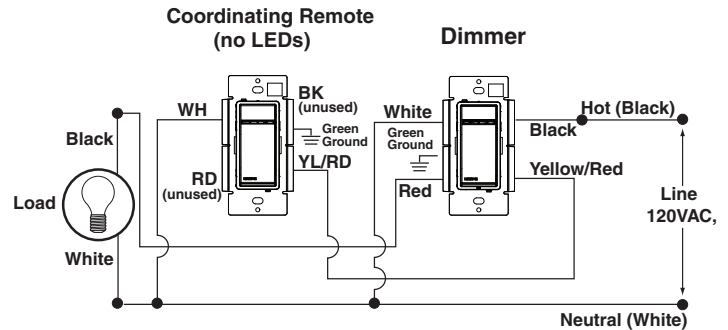

#### Dimmers

VPE04, VPE06  
VPX10

#### Fan Speed Control

VPF01

#### Switch

VPS15  
VPT24

#### NOTES:

- 1) VPS15, VPOSR-10 and VP00R-10 have screw terminals, VPE04, VPE06, VPX10, VPF01 and VPT24 have leads
- 2) Black and Red terminals on coordinating remotes are unused

#### Coordinating Dimmer Remote

VP00R-10

#### Coordinating Switch Remote

VPOSR-10

Sharing a neutral wire may cause flickering or other unforeseen issues. Connect all lighting/fan speed controls to the same phase or run a separate neutral to each phase. Consult the Leviton tech line if problems persist.

## Leviton Mfg. Co., Inc.

201 North Service Road, Melville, NY 11747-3138 Tech Line: 1-800-824-3005 Fax: 1-800-832-9538 www.leviton.com  
© 2009 Leviton Manufacturing Co., Inc. All rights reserved. Subject to change without notice.

**WIRING DIAGRAMS**

**Diagram 6**

3-way wiring for incandescent or magnetic low voltage dimmer with matching remote.

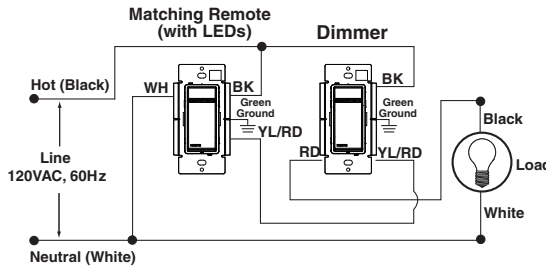

**Dimmers**

- VPI06
- VPM06
- VPM10

**Matching Dimmer Remote**

VPO0R-1L

**Matching Switch Remote**

VPOSR-1L

**NOTES:**

- 1) VPI06, VPM06, VPO0R-1L and VPOSR-1L have screw terminals, VPM10 has leads

**Diagram 7**

3-way wiring for electronic low voltage dimmer, Mark 10® Powerline dimmer, fan speed control, switch or timer switch with matching remote.

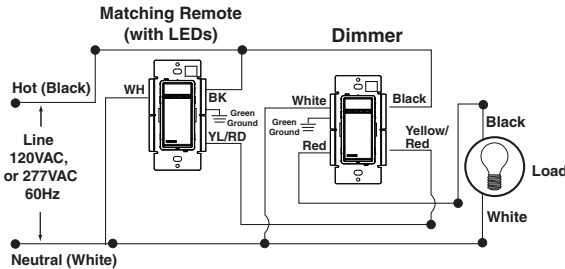

**Dimmers**

- VPE04
- VPE06
- VPX10
- VPX12-7L

**Fan Speed Control**

- VPF01
- Switch**
- VPS15
- VPT24

**Matching Dimmer Remotes**

- VPO0R-1L
- VPO0R-7L

**Matching Switch Remote**

VPOSR-1L

**NOTES:**

- 1) VPS15, VPOSR-1L and VPO0R-1L have screw terminals, VPE04, VPE06, VPX10, VPF01, VPX12-7L, VPO0R-7L and VPT24 have leads

**Diagram 8**

Single pole wiring for Hi-lume® fluorescent dimmer

**Dimmers**

- VPH08
- VPH06-7L

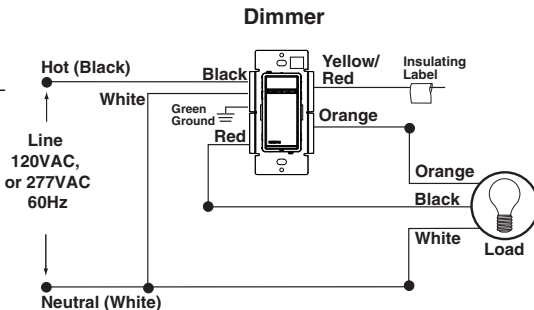

**Diagram 9**

3-way wiring for Hi-lume® fluorescent dimmer with coordinating remote.

**Dimmer**

VPH08

**Coordinating Switch Remote**

VPOSR-10

**Coordinating Dimmer Remote**

VP00R-10

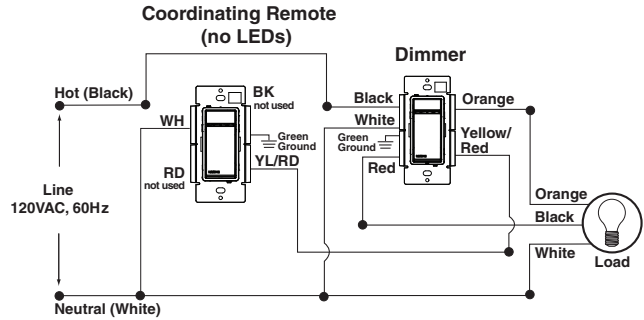

**NOTES:**

- 1) Coordinating remote VP00R-10 and VPOSR-10 have screw terminals, VPH08 has leads
- 2) Black and Red terminals on coordinating remote are unused

**Diagram 10**

3-way wiring for Hi-lume® fluorescent dimmer with matching remote.

**Dimmers**

- VPH06-7L
- VPH08-1L

**Matching Dimmer Remotes**

- VPO0R-1L
- VPO0R-7L

**Matching Switch Remote**

VPOSR-1L

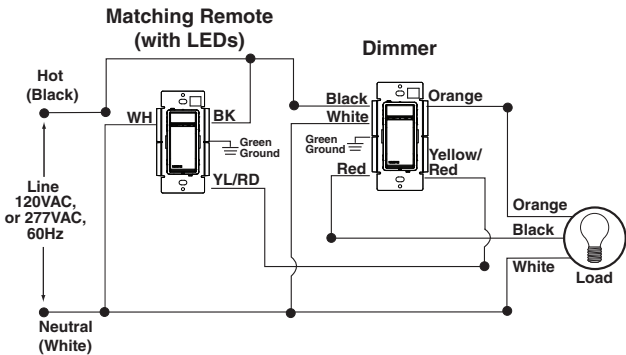

**NOTES:**

- 1) VPO0R-1L has screw terminals, VPH08-1L, VPH06-7L and VPO0R-7L have leads

Sharing a neutral wire may cause flickering or other unforeseen issues. Connect all lighting/fan speed controls to the same phase or run a separate neutral to each phase. Consult the Leviton tech line if problems persist.

Vizia + Commercial Grade Lighting Controls Collection

**Leviton Mfg. Co., Inc.**

201 North Service Road, Melville, NY 11747-3138 Tech Line: 1-800-824-3005 Fax: 1-800-832-9538 www.leviton.com  
 © 2009 Leviton Manufacturing Co., Inc. All rights reserved. Subject to change without notice.

**DIMENSIONS**

All Dimmers, Quiet Fan Speed Control, Electronic Switch, Matching and Coordinating Remotes

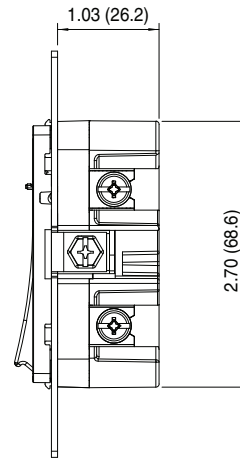
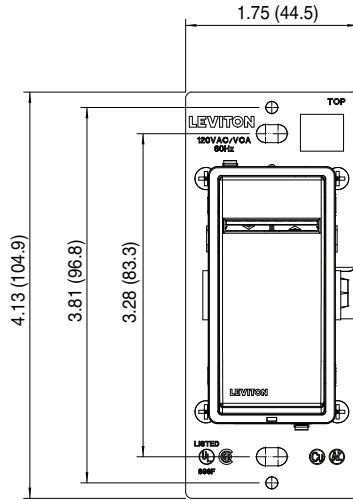

Dimmer with LEDs Shown - VPI06, VPM06, VP00R-1L, VP00R-10, VP0SR-1L, VP0SR-10, VPS15

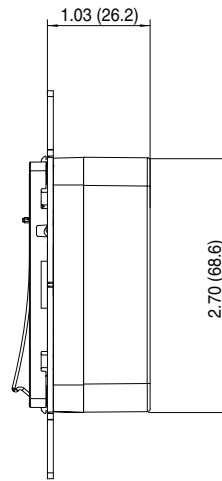
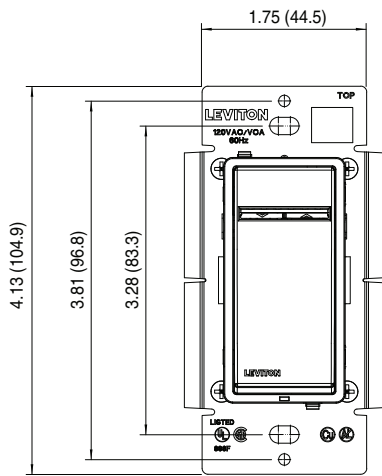

Dimmer with LEDs Shown - VPM10, VP00R-7L, VPF01\*

\*Note: VPF01 does not have side fins

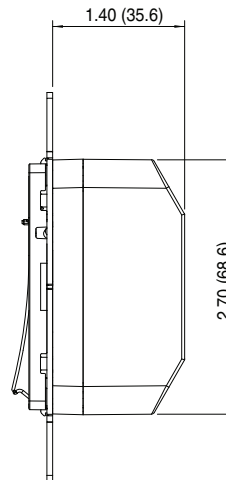
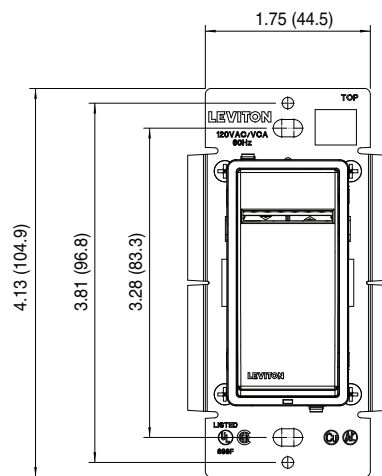

Dimmer with LEDs shown - VPE04, VPE06, VPH08, VPH06-7L, VPX10, VPX12-7L, VPT24-1P\*

\*Note: VPT24 does not have side fins

**Leviton Mfg. Co., Inc.**

201 North Service Road, Melville, NY 11747-3138 Tech Line: 1-800-824-3005 Fax: 1-800-832-9538 www.leviton.com  
 © 2009 Leviton Manufacturing Co., Inc. All rights reserved. Subject to change without notice.

## PART 1 — GENERAL

### 1.01 SUMMARY

- A. Section Includes: Vizia +® style timer switch, switch, dimmers, fan speed control (and corresponding remote units), for the areas indicated on the drawings, specifications, and load schedule
- B. Related Sections: Section 16570 (Dimming Controls), Section 16580 (Ballasts)

### 1.02 REFERENCES

#### A. Vizia +® Lighting Controls:

1. UL Standard 1472
2. UL 60730
3. CSA Standard C22.2 No. 184-M1988
4. IEC Level 4 Surge and Fast Transients
5. California Title 24 2005
6. UL Standard 1472
7. FCC Part 15, Class B for Residential Compliance
8. MIL. STD 105 or ANSI Z1.4
9. UL Listed (File #E-31373) and (File #E-328809)
10. CSA Certified (File #LR-3413)

### 1.03 SYSTEM DESCRIPTION

- A. Permanently installed, wallbox mounted timer switch, switch, dimmers and corresponding remote units
- B. Permanently installed, wallbox mounted fan speed control and corresponding remote units

### 1.04 SUBMITTALS

- A. Submit manufacturer's standard catalog data giving all product, application, wiring, and installation information on all basic components and wallplates. Provide test data and/or samples for finish, color and texture as required to demonstrate conformance with PART 2 of this specification.

### 1.05 QUALITY ASSURANCE

- A. Manufacturer shall have a minimum of 20 years continuous experience in the manufacture of wallbox mounted dimming products.
- B. Dimmers, timer switch, switch and fan speed control shall be UL Listed, CSA approved and NOM Certified specifically for each required load (tungsten, electronic low voltage ballast, magnetic low voltage ballast, Mark 10® *Powerline* fluorescent, and Hi-lume® fluorescent, fan and motor). Manufacturer shall provide file card or certificate upon request. Universal load type devices shall not be acceptable.
- C. Source Limitations: To assure compatibility, all devices shall be obtained from a single source with complete responsibility over all controls, including accessory products. The use of subcontracted component assemblers is not acceptable.
- D. Manufacturer shall be ISO 9001 certified and provide a copy of the certificate upon request.

### 1.06 WARRANTY

- A. Manufacturer's Warranty: All equipment shall be warranted free of defects in materials and workmanship.
1. Warranty Period: Five years from date of purchase
  2. Owner Rights: Manufacturer's warranty is in addition to, not a limitation of, other rights the Owner may have under contract documents.

## PART 2 — PRODUCTS

### 2.01 ACCEPTABLE MANUFACTURERS

- A. Leviton Manufacturing Co., Inc.
- B. Unless otherwise noted, all basic components (dimmer, fan speed control, timer switch, switch and corresponding remote units) shall be provided by one manufacturer.

### 2.02 EQUIPMENT

#### A. Leviton Vizia +® Lighting Controls

##### 1. Performance

- a. Controls shall provide full range, continuously variable control of light intensity.

- b. Dimmers require 40W minimum load.
- c. Controls shall fit in the Decora wallplate opening only. Controls shall be thin profile with no exposed heat sink/yoke and shall fit in a single gang 18 cubic inch wallbox. All controls shall have a high gloss finish.
- d. Controls shall provide single pole, 3-way, or multi-location control with choice of remote devices.
- e. Matching Remote Dimmer VP00R-1L/-7L shall provide green LED Locator and LED Brightness display and shall provide 3-way or up to 5 location control. Matching Remote shall require neutral connection.
- f. Matching Remote Switch VP0SR-1L with green LED locator shall provide 3-way or up to 5 location control. Matching Remote shall require a neutral connection.
- g. Coordinating Remote Dimmer VP00R-10 shall provide 3-way or up to 10 location control. Coordinating Dimmer Remote shall require neutral connection in specific applications.
- h. Coordinating Remote Switch VP0SR-10 shall provide 3-way or up to 10 location control. Coordinating Switch Remote shall require neutral connection in specific applications.
- i. Load bearing triac controls shall provide air gap switch to totally disconnect power from load during OFF condition. Air gap switch shall be concealed during normal operation and shall be accessible without removing wallplate.
- j. Lighted Controls shall provide a green LED locator light that shall illuminate when the lights are OFF to facilitate easy access in the dark.
- k. Dimmers, Fan Speed Control and Remote devices shall provide a Dim/Bright bar that allows light level (or fan speed) to be set by the user on lighted devices. A seven-step LED indicator shall be integrated in the Push Pad to show relative load status. Push Pad with return-to-neutral design shall provide preset ON/OFF control independent of Dim/Bright bar. Push Pad and Dim/Bright bar shall be ergonomically designed for precise tactile quality with distinct actuation confirmation.
- l. Dimming Controls shall provide a default setting in which Push Pad preset ON switching returns lights to last selected level.
- m. Controls shall provide switching from OFF to ON when Push Pad is pressed.
- n. Dimming Controls shall provide intuitive "house guest" feature allowing lights to be dimmed to OFF by pressing and holding the Dim/Bright bar. Preset level shall not be changed.
- o. Dimming Controls shall provide an adjustable minimum brightness setting to accommodate lighting loads with a minimum turn on voltage.
- p. Programmable Dimmer settings for energy save, minimum brightness level, preset ON, almost OFF, ON fade rate, OFF fade rate, LED options and restore defaults shall not require tools or wallplate removal.
- q. Dimmer Controls shall provide an energy save mode that allows the user to adjust the maximum brightness level to reduce energy consumption. (Default setting is 100% maximum brightness setting; it shall be activated by user if desired).
- r. Dimmer Controls shall provide the ability to change the selected brightness level by pressing the Dim/Bright bar while the lights are OFF. LED display shall show selected level.
- s. Dimmer Controls shall provide a Preset ON feature that allows the user to set the brightness level that the lights will turn on to, regardless of the previous light level at which it was turned OFF. (Default setting is preset ON inactive; it shall be activated by the user if desired).
- t. Dimmer Controls shall provide an Almost OFF feature that allows the user to set the brightness level that lights will dim to when the push pad is pressed to turn OFF. In this mode, the lights will remain ON. (Default setting is OFF; it shall be activated by the user if desired).
- u. Dimmer Controls shall provide a selectable fade rate for ON and OFF switching. Default setting shall be .5 seconds for ON and .5 seconds for OFF.
- v. Dimmer and Fan Speed Controls shall provide a means to timeout the locator light and/or LED Brightness display.
- w. Dimmer, Fan Speed, Timer Switch and Switch Controls shall provide a means to reactivate the factory default settings.

#### Leviton Mfg. Co., Inc.

201 North Service Road, Melville, NY 11747-3138 Tech Line: 1-800-824-3005 Fax: 1-800-832-9538 www.leviton.com  
© 2009 Leviton Manufacturing Co., Inc. All rights reserved. Subject to change without notice.

## PRODUCT SPECIFICATIONS



- x. Within rated capacity, dimmers shall be available for direct control of incandescent, electronic low voltage, magnetic low voltage, Mark 10® *Powerline* fluorescent, and Hi-lume® or Eco-10® (Eco-Series) fluorescent loads. Fan speed control, timer switch and switch shall also be available.
- y. Controls may require the removal of fins in multi-gang installations. Controls shall be derated in accordance with manufacturer's specifications in multi-gang installations.
- z. Controls shall provide transient surge protection to IEC Level 4.
- aa. Controls shall provide ESD protection to IEC 1000 4-2 Level 4 to protect against damage and memory loss due to static discharges.
- bb. Dimmers shall provide RFI filtering for radio, audio, and video equipment.
- cc. Controls shall incorporate power failure memory. Should power be interrupted and subsequently returned, the load will come back on to the last level set prior to the power interruption.
- dd. Controls shall operate in an ambient temperature range of 0°C (32°F) to 40°C (131°F).

### 2. Incandescent Dimmers

- a. Dimmers shall have a maximum output of no less than 95% of line voltage.
- b. VPI06 rated for 600W of 120V incandescent load shall provide 4 terminal screws for Line, Load, Remote and Ground.
- c. VPM10 rated for 1000W of 120V incandescent load shall provide 4 wire leads for Line, Load, Remote and Ground.

### 3. Electronic Low Voltage (ELV) Dimmers

- a. Dimmers shall contain circuitry specifically designed to control the input of electronic (solid state) low voltage transformers. Dimmers using standard phase control shall not be acceptable.
- b. VPE04 (400W) and VPE06 (600W) dimmers shall have a resettable overload protection that automatically shuts off when dimmer capacity is exceeded.
- c. Dimmers shall provide 5 wire leads for Line, Load, Neutral, Remote and Ground.

### 4. Magnetic Low Voltage (MLV) Dimmers

- a. VPM06 shall provide direct control of up to 600VA of 120V magnetic low voltage load and shall provide 4 terminal screws for Line, Load, Remote and Ground.
- b. VPM10 shall provide direct control of up to 1000VA of 120V magnetic low voltage load and shall provide 4 wire leads for Line, Load, Remote and Ground.
- c. Dimmer shall contain circuitry specifically designed to control and provide a symmetrical AC waveform to the input of magnetic low voltage transformers per UL 1472 section 5.11.
- d. Dimmer shall not cause a magnetic low voltage transformer to operate above the transformers rated operating current or temperature.
- e. Dimmers shall have a maximum output of no less than 95% of line voltage.

### 5. Fluorescent Dimmers

- a. Fluorescent dimmers shall provide direct control of fluorescent dimming ballasts up to the manufacturer's specified rating.
- b. VPX10 shall be rated 1000VA to control 120V Mark 10® *Powerline* or Tu-Wire® ballasts and provide 5 wire leads for Line, Load, Neutral, Remote and Ground.
- c. VPX12 shall be rated 1200VA to control 277V Mark 10® *Powerline* ballasts and provide 5 wire leads for Line, Load, Neutral, Remote and Ground.

- d. VPH08 shall be rated 8A to control 120V Hi-lume® or Eco-10® (Eco-Series) ballasts and provide 6 wire leads for Line, Load, Neutral, Signal, Remote and Ground.
- e. VPH06 shall be rated 6A to control 277V Hi-lume® or Eco 10® (Eco-Series) ballasts and provide 6 wire leads for Line, Load, Neutral, Signal, Remote and Ground.

### 6. Fan Speed Control

- a. VPF01 Quiet Fan Speed Control shall be rated 1.5A and provide Low-Medium-High speed settings and OFF.
- b. VPF01 shall provide microprocessor controlled "kick-start" to allow fan to go directly from OFF to any speed setting.
- c. VPF01 shall provide 5 wire leads for Line, Load, Neutral, Remote and Ground.

### 7. Switch and Timer Switch

- a. VPS15 and VPT24 shall be completely compatible with Vizia +® lighting controls and provide ON/OFF Push Pad ergonomically designed for precise tactile quality with distinct actuation confirmation.
- b. VPS15 and VPT24 shall provide a green LED locator light that shall illuminate when the lights are OFF to facilitate easy access in the dark.
- c. VPS15 electronic switch shall be rated 15A 120VAC and provide 5 screw terminals for Line, Load, Neutral, Remote and Ground.
- d. VPT24 electronic timer switch shall be rated 15A, resistive/inductive, 1800W incandescent, 1HP@120VAC and provide 5 leads for Line, Load, Neutral, Remote and Ground.
- e. VPS15 and VPT24 electronic switch shall provide single pole, 3-way, or multi-location control with choice of remote switches.
- f. Matching Remote Switch VPOSR-1L shall provide green LED locator and shall provide 3-way or up to 5 location control and shall require neutral connection.
- g. Coordinating Remote Switch VPOSR-10 shall provide 3-way or up to 10 location control and shall require neutral connection when used with devices requiring neutral connection.

### 2.03 SOURCE QUALITY CONTROL

- A. All controls shall be 100% functionally tested at the time of manufacture. Statistical sampling plan shall not be acceptable.

## PART 3 — EXECUTION

### 3.01 INSTALLATION

- A. Contractor shall furnish all devices, labor and other services necessary for the proper installation of the devices as indicated on the drawings and specified herein.
- B. Contractor shall be responsible for derating lighting controls capacity in multi-gang installations.
- C. Devices shall be installed utilizing manufacturer's recommended application, wiring and installation instructions.
- D. Contractor shall provide frameless wallplate covers per specification 2.02 for all devices ganged in a common box. Contractor shall provide barriers within the box where required by code.
- E. Contractor shall ensure neutral wires are not shared to provide for intended functionality of Leviton Lighting/Fan Speed Controls.

### 3.02 FIELD QUALITY CONTROL

- A. Leviton technical hotline available 8:30AM-7:00PM E.T.  
Monday-Friday: 1-800-824-3005
- B. Supplemental information shall be provided on the Leviton website at [www.leviton.com](http://www.leviton.com)

Vizia +® and Vizia RF +® are registered trademarks of Leviton Manufacturing Inc. Covered by one or more U.S. and Foreign Patents and patents pending. Mark 10® is a registered trademark of Koninklijke Philips Electronics N.V. Hi-lume®, Tu-Wire® and Eco-10® are registered trademarks of Lutron Electronics Co., Inc.

### Leviton Manufacturing Co., Inc.

201 North Service Road, Melville, NY 11747-3138 Tech Line: 1-800-824-3005 Fax: 1-800-832-9538 [www.leviton.com](http://www.leviton.com)

### Leviton Manufacturing of Canada, Ltd.

165 Hymus Boulevard, Pointe Claire, Quebec H9R 1E9 • Telephone: 1-800-469-7890 • FAX: 1-800-563-1853

### Leviton S. de R.L. de C.V.

Lago Tana 43, Mexico DF, Mexico CP 11290 • Tel. (+52) 55-5082-1040 • FAX: (+52) 5386-1797 • [www.leviton.com.mx](http://www.leviton.com.mx)

### Visit our Website at: [www.leviton.com](http://www.leviton.com)

© 2009 Leviton Manufacturing Co., Inc. All rights reserved. Subject to change without notice.



G-7882B/109-sw