

# Light control solutions

## Classrooms

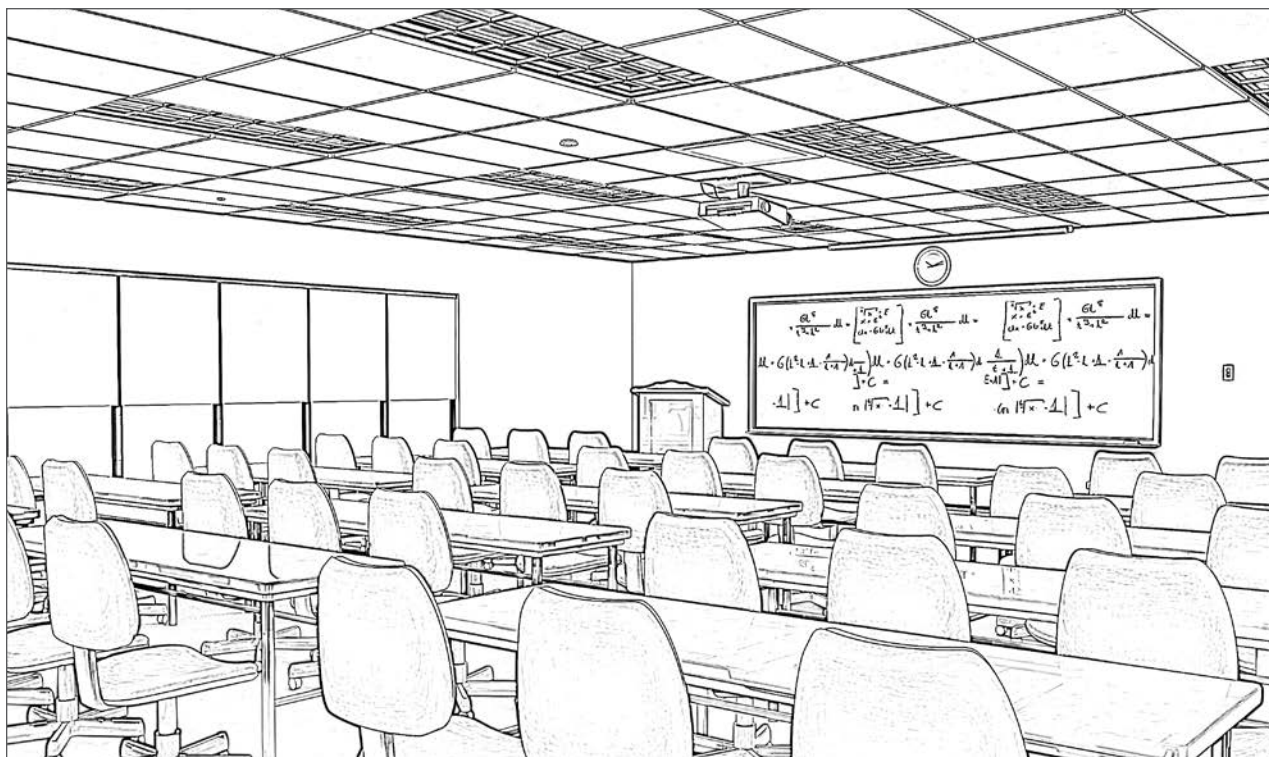

### Total Light Management™ in classrooms

Classrooms are multifunctional spaces that benefit from various lighting scenes, enable video presentations, and support new teaching methods.

**The challenge:** Enhance the learning environment by creating unique lighting scenes for different activities. Control multiple zones of light to reduce lighting energy costs.

**The opportunity:** Utilize energy-saving light control strategies, to enhance the quality of light and reduce costs.

### Functions:

- Classroom instruction
- Video presentations
- Use of whiteboards, electronic smart boards, and computers

### Requirements:

- Meet energy code requirement for automatic shut-off
- Provide multiple preset lighting conditions
- Control at entry door and teacher station
- Comply with ASHRAE/IES 90.1 -2007 Lighting Power Density (LPD) requirements of 1.24 W/ sq. ft.
- Comply with CHPS and LEED requirements

# Classroom examples

Control functionality		Basic - multi-level switching	Basic - multi-level dimming with daylighting
Define the space	<b>Activities</b>	<ul style="list-style-type: none"> <li>Classroom instruction</li> <li>Video presentations</li> </ul>	<ul style="list-style-type: none"> <li>Classroom instruction</li> <li>Video presentations</li> </ul>
	<b>Typical interior finish level</b>	Basic finish level	Basic finish level
	<b>Lights and shades</b> - Zones - Fixture types	<b>2 switched lighting zones</b> <ul style="list-style-type: none"> <li>Recessed parabolic fluorescent</li> </ul>	<b>2 dimmed lighting zones</b> <ul style="list-style-type: none"> <li>Recessed direct/indirect fixture</li> </ul>
Light control strategies	<b>Code-required strategies</b>	Occupancy sensor	<ul style="list-style-type: none"> <li>Occupancy sensor</li> <li>Daylight sensor</li> </ul>
	<b>Additional strategies</b>	n/a	n/a

Note: Use the Lutron® PowPak™ CCO module to integrate Radio Powr Savr™ sensors with HVAC and other building system, and to maximize energy savings. For information, contact your Lutron representative, or visit [www.lutron.com/EnergiTriPak](http://www.lutron.com/EnergiTriPak)

	Intermediate	Advanced
	<ul style="list-style-type: none"> <li>• Classroom instruction</li> <li>• Video presentations</li> </ul>	Classroom with permanent AV equipment and computer stations
	Intermediate finish level	High-end finish level
	<p><b>3 dimmed lighting zones</b></p> <ul style="list-style-type: none"> <li>• Pendant linear fluorescent</li> <li>• Linear whiteboard fixture</li> </ul>	<p><b>6 dimmed lighting zones</b></p> <ul style="list-style-type: none"> <li>• Pendant linear fluorescent fixture</li> <li>• Linear whiteboard fixture</li> <li>• Plug-in load control (computer monitors)</li> </ul> <p><b>1 shade zone</b></p> <ul style="list-style-type: none"> <li>• Blackout shades</li> </ul>
	<ul style="list-style-type: none"> <li>• Occupancy sensor</li> <li>• Daylight sensor</li> </ul>	<ul style="list-style-type: none"> <li>• Occupancy sensor</li> <li>• Daylight sensor</li> </ul>
	<ul style="list-style-type: none"> <li>• Preset scenes</li> <li>• 1% fluorescent dimming</li> </ul>	<ul style="list-style-type: none"> <li>• Preset scenes</li> <li>• 1% fluorescent dimming</li> <li>• AV integration</li> <li>• Shades</li> </ul>

# Basic classroom - multi-level switching

Interior space classroom for general use. Incorporates a recessed fluorescent lighting system plus whiteboard lighting.





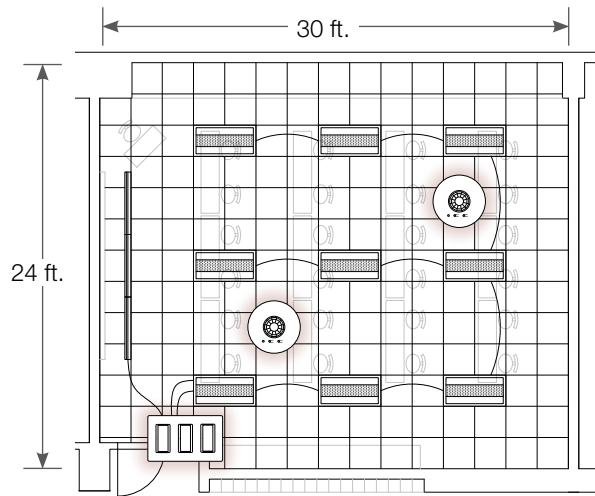

## Control strategies:

- Occupancy sensing
- Switched fluorescent lighting



Controls not to scale with reflected ceiling plan

## Key

 (+  )*	2x4, 2-lamp 32W T8 recessed direct/indirect - with bi-level switching ballast
 (+  )*	Recessed linear whiteboard 32W T8 - with switching ballast
	Maestro Wireless® switch with 3-gang Claro® wallplate
	Radio Powr Savr™ wireless, ceiling-mount, occupancy sensor

\* Not shown in reflected ceiling plan

## Maestro Wireless switch

- Easy to operate
- Installs in as little as 15 minutes
- Allows control of up to 10 sensors and wireless controls

## Radio Powr Savr wireless, ceiling-mount, occupancy sensor

- Installs in as little as 15 minutes
- Communicates with compatible Lutron® dimmers, switches and light control systems
- Uses reliable Clear Connect™ Radio Frequency (RF) Technology, which ensures smooth, consistent performance

**One-line diagram:**

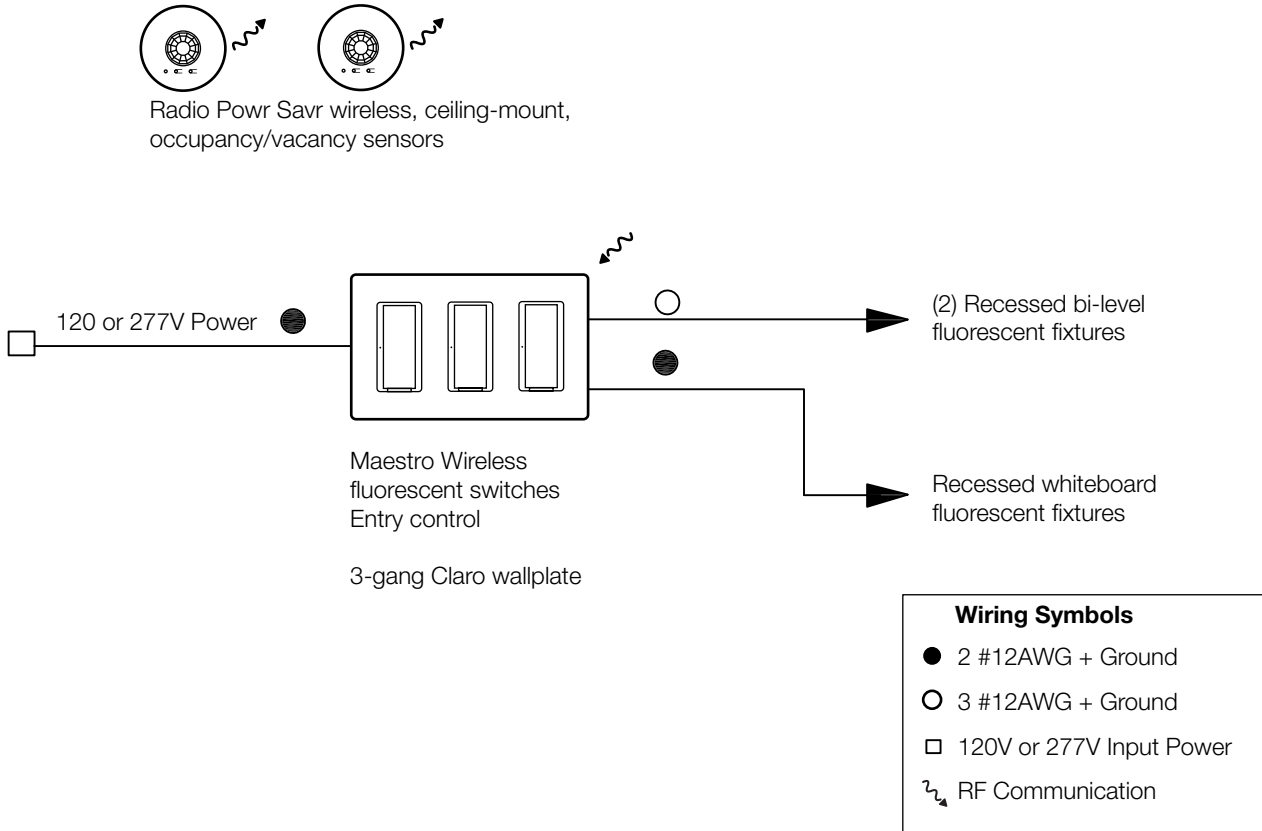

<b>Bill of materials</b>		
<b>Control</b>	<b>Qty.</b>	<b>Description</b>
MRF2-8S-DV-WH	3	Maestro Wireless fluorescent switch
LRF2-OCR2B-P-WH	2	Radio Powr Savr wireless, ceiling-mount, occupancy sensor
CW-3-WH	1	3-gang Claro wallplate
<b>Materials cost (suggested list price, labor not included) = \$585.00</b>		

# Basic classroom - dimming with daylighting

Perimeter classroom for general use, incorporating recessed fluorescent lighting plus whiteboard lighting.

## Control strategies:



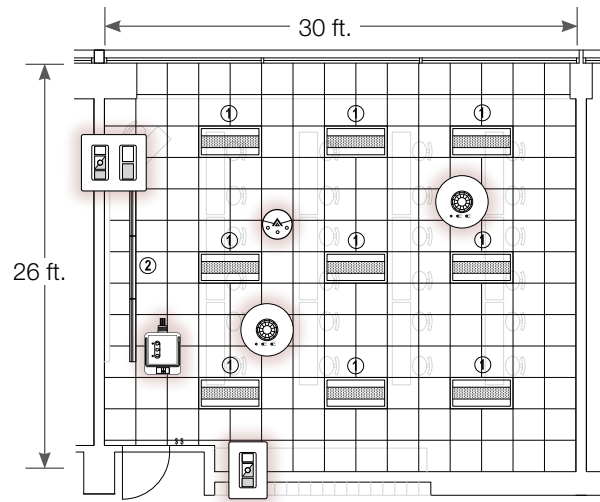



- Occupancy sensing
- Preset, dimmed fluorescent lighting
- Daylight sensing

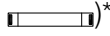

Controls not to scale with reflected ceiling plan

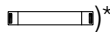
① Indicates control zone

## Key

 (+  )*	2x4, 2-lamp 32W T8 recessed indirect - with EcoSystem® H-Series ballast
 (+  )*	Recessed linear whiteboard 32W T8 - with EcoSystem H-Series ballast
 **	PowPak™ dimming module with EcoSystem
	Pico wireless controls with 1-gang and 2-gang Claro® wallplate
	Radio Powr Savr™ wireless, ceiling-mount, occupancy sensor
	Radio Powr Savr wireless daylight sensor

\* Not shown in reflected ceiling plan

\*\* Located above ceiling

## Pico wireless control

- Provides wireless dimming control of lighting loads; communicates with PowPak dimming module with EcoSystem

## PowPak dimming module with EcoSystem

- Allows connected lighting loads to be dimmed in response to wireless occupancy/vacancy sensors, daylight sensors, and Pico controls

## Radio Powr Savr wireless, ceiling-mount, occupancy sensor

- Installs in as little as 15 minutes
- Communicates with compatible Lutron® dimmers, switches and light control systems
- Uses reliable Clear Connect™ Radio Frequency (RF) Technology, which ensures smooth, consistent performance

## Radio Powr Savr wireless daylight sensor

- Allows connected dimmers, switches, and lighting control systems to automatically adjust light level based on available daylight

**One-line diagram:**

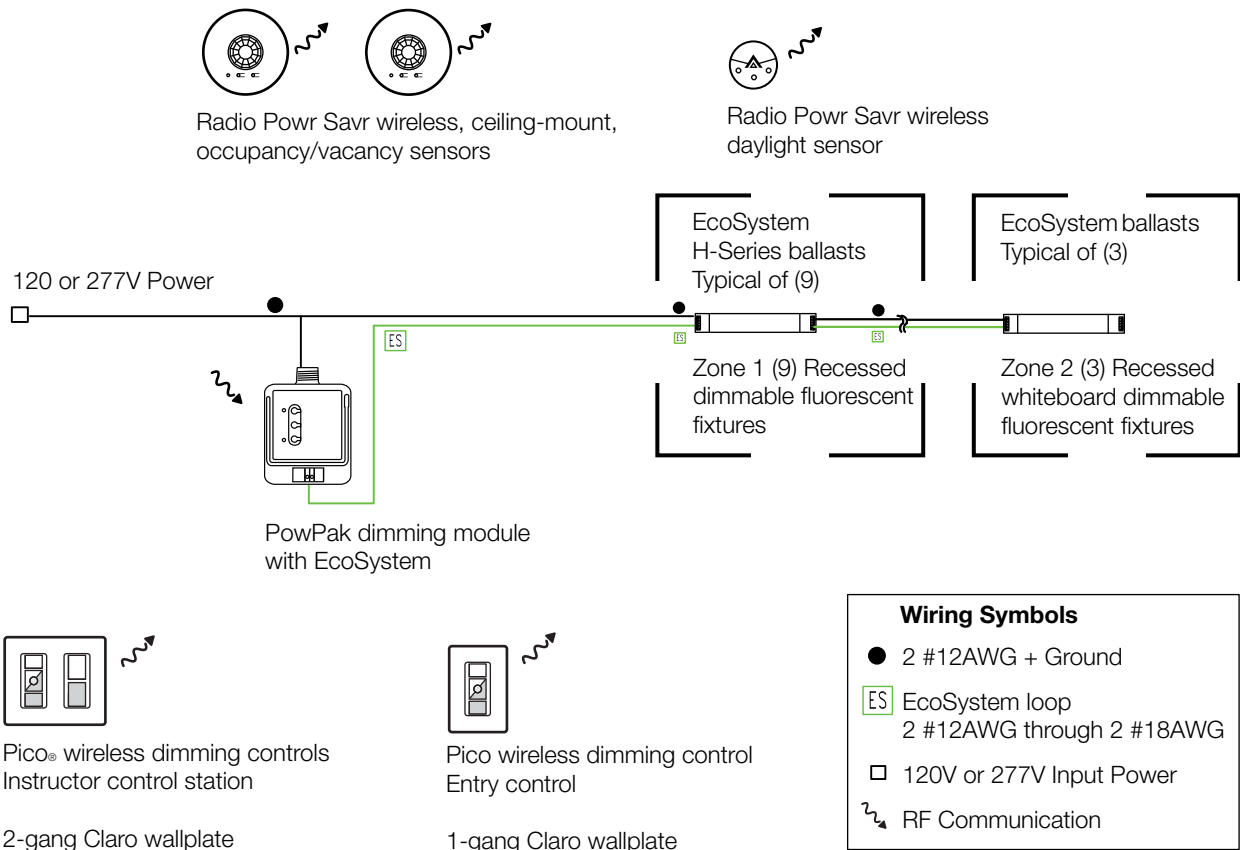

Bill of materials		
Control	Qty.	Description
RMJ-ECO32-DV-B	1	PowPak dimming module with EcoSystem
MRF2-3BRL-L-WH	2	Pico wireless controls
LRF2-OCR2B-P-WH	2	Radio Powr Savr wireless, ceiling-mount, occupancy sensor
LRF2-DCRB-WH	1	Radio Powr Savr wireless, ceiling-mount, daylight sensor
EHD T832 C U 2 10	9	EcoSystem dimming H-Series ballast - (2) T8 lamps <sup>1</sup>
EHD T832 C U 1 10	3	EcoSystem dimming H-Series ballast - (1) T8 lamp <sup>1</sup>
CW-1-WH	1	1-gang Claro wallplate
CW-2-WH	1	2-gang Claro wallplate
<b>Materials cost (suggested list price, labor not included) = \$1,534.70</b>		

<sup>1</sup> Ballasts typically purchased with fixtures. Price does not include cost of fixtures.

# Intermediate classroom

Perimeter classroom for general use. Incorporates linear pendant fluorescent lighting with independent upright and downlight, plus recessed whiteboard lighting.

## **Control strategies:**

- Occupancy sensing
- Preset, dimmed fluorescent lighting
- Daylight sensing

## **Pico® wireless controls**

- Provides wireless dimming control of lighting loads; communicates with PowPak™ dimming module with EcoSystem®

## **PowPak dimming module with EcoSystem**

- Allows connected lighting loads to be dimming in response to wireless occupancy/vacancy sensors, daylight sensors, and Pico controls

## **Radio Powr Savr™ wireless, corner-mount, occupancy sensor**

- Installs in as little as 15 minutes
- Communicates with compatible Lutron® dimmers, switches and light control systems
- Uses reliable Clear Connect™ Radio Frequency (RF) Technology, which ensures smooth, consistent performance

## **Radio Powr Savr wireless daylight sensor**

- Allows connected dimmers, switches, and lighting control systems to automatically adjust light level based on available daylight
- Uses reliable Clear Connect™ Radio Frequency (RF) Technology, which ensures smooth, consistent performance



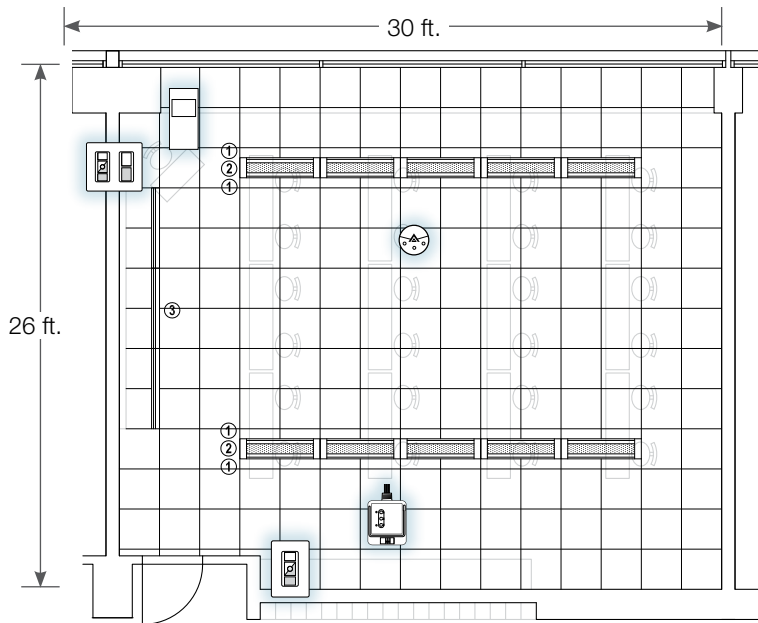



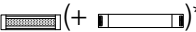
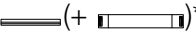

Controls not to scale with reflected ceiling plan

① Indicates control zone

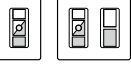
## Key

 *	2/1 32W T8 pendant linear independent uplight/downlight - with EcoSystem H-Series dimming ballast
 *	Recessed linear whiteboard 32W T8 - with EcoSystem H-Series dimming ballast
 **	PowPak dimming module with EcoSystem
	Pico wireless controls with 1-gang and 2-gang Claro® wallplate
	Radio Power Savr™ wireless, corner-mount, occupancy sensor
	Radio Power Savr wireless daylight sensor

\* Not shown in reflected ceiling plan

\*\* Located above ceiling

# Intermediate classroom

## One-line diagram:

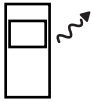

Radio Powr Savr™ wireless, corner-mount, occupancy/vacancy sensor



Radio Powr Savr wireless daylight sensor

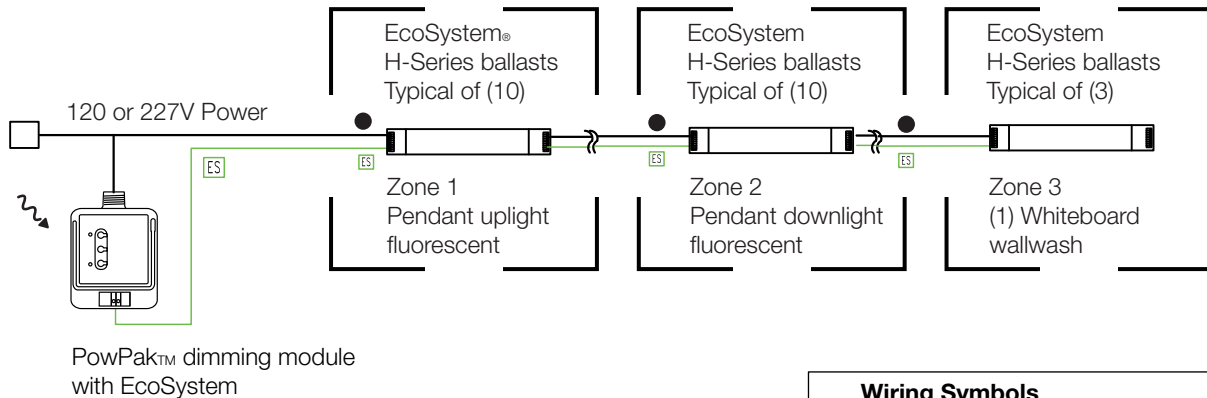

### Wiring Symbols

- 2 #12AWG + Ground
- ES EcoSystem loop  
2 #12AWG through 2 #18AWG
- Input Power
- ⤴ RF Communication



Pico® wireless dimming controls Instructor control station

2-gang Claro® wallplate



Pico wireless dimming control Entry control

1-gang Claro wallplate

<b>Bill of materials</b>		
<b>Control</b>	<b>Qty.</b>	<b>Description</b>
RMJ-ECO32-DV-B	1	PowPak dimming module with EcoSystem
MRF2-3BRL-L-WH	2	Pico wireless controls
MRF2-2B-L-WH	1	Pico wireless control
LRF2-OKLB-P-WH	2	Radio Powr Savr wireless, corner-mount, occupancy sensor
LRF2-DCRB-WH	1	Radio Powr Savr wireless daylight sensor
EHD T832 C U 2 10	10	EcoSystem H-Series fluorescent dimming ballast - (2) T8 lamps <sup>1</sup>
EHD T832 C U 1 10	13	EcoSystem H-Series fluorescent dimming ballast - (1) T8 lamp <sup>1</sup>
CW-2-WH	1	2-gang Claro wallplate
CW-1-WH	1	1-gang Claro wallplate
<b>Materials cost (suggested list price, labor not included) = \$2,419.70</b>		

<sup>1</sup> Ballasts typically purchased with fixtures.

# Advanced classroom and computer lab

Perimeter computer lab for computer training. Incorporates linear pendant fluorescent lighting with independent upright and downlight, plus recessed whiteboard lighting and shade control.

## **Control strategies:**

- Occupancy sensing
- Daylight harvesting
- Preset, dimmed fluorescent
- Blackout shades

## **Pico® wireless controls**

- Provides wireless dimming control of lighting loads; communicates with Energi Savr Node™ with EcoSystem® and shades

## **Energi Savr Node with EcoSystem and shades**

- Allows easy integration of sensors, lighting fixtures with digital ballasts, dimming and switching loads
- Can also integrate with other building systems

## **Sivoia® QS Wireless shades**

- Ultra-quiet control of daylight at the touch of a button

## **Radio Powr Savr™ wireless, wall-mount, occupancy/vacancy sensor**

- Installs in as little as 15 minutes
- Communicates with compatible Lutron® dimmers, switches and light control systems
- Uses reliable Clear Connect™ Radio Frequency (RF) Technology, which ensures smooth, consistent performance

## **Radio Powr Savr wireless daylight sensor**

- Allows connected dimmers, switches, and lighting control systems to automatically adjust light level based on available daylight

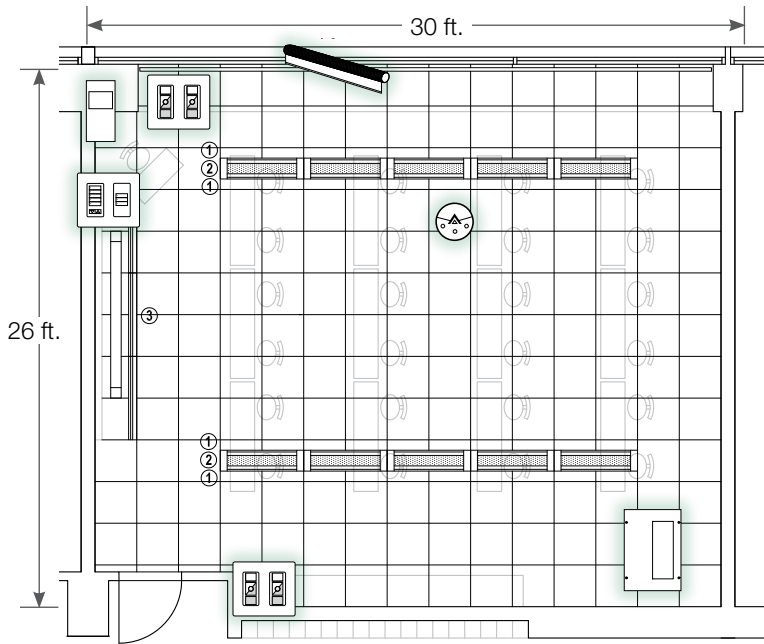

Controls not to scale with reflected ceiling plan

① Indicates control zone

## Key

	2/1 32W T8 pendant linear independent uplight/downlight - with EcoSystem H-Series dimming ballast
	Recessed linear whiteboard 32W T8 - with EcoSystem H-Series dimming ballast
	seeTouch control for instructor control location
	Pico wireless controls with 2-gang Claro® wallplates
	QS Sensor module
	Sivoia QS Wireless shades
	Radio Powr Savr wireless, wall-mount, occupancy sensor
	Radio Powr Savr wireless ceiling-mount daylight sensor
	Energi Savr Node with EcoSystem and shades
	Plug-in appliance module

\* Not shown in reflected ceiling plan

\*\* Located above ceiling

# Advanced classroom and computer lab

## One-line diagram:

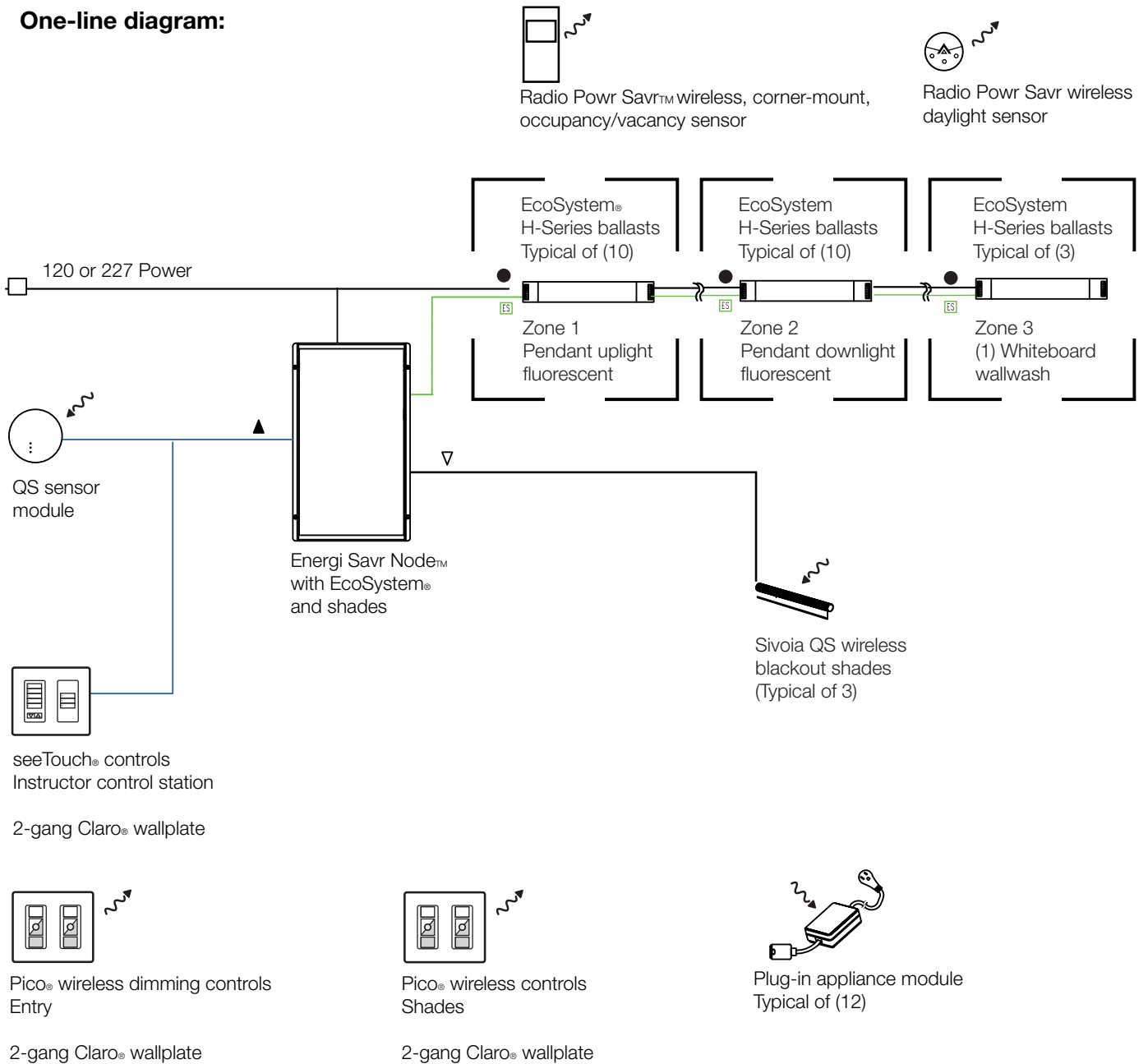

### Wiring Symbols

- 2 #12AWG + Ground
- ES EcoSystem loop  
2 #12AWG through 2 #18AWG
- Input Power
- ▲ QS Link: Lutron cable GRX-CBL-346S or GRX-PCBL-346S
- ▽ 2 #18AWG
- RF Communication

<b>Bill of materials</b>		
<b>Control</b>	<b>Qty.</b>	<b>Description</b>
MRF2-3BRL-L-WH	2	Pico wireless controls
QSR4P-3R-WH-E09	2	Pico wireless controls for shades
QSW2-5BRLI-WH	1	seeTouch instructor control station
QSW2-2BRLI-WH	1	
CW-2-WH	1	
QSN-2ECO-PS120	1	Energi Savr Node with EcoSystem and shades
LRF2-OKLB-P-WH	2	Radio Powr Savr wireless, corner-mount, occupancy sensor
LRF2-DCRB-WH	1	Radio Powr Savr wireless, ceiling-mount, daylight sensor
QSM2-4W-C	1	QSM Sensor module
CW-2-WH	2	Claro 2-gang wallplate
MRF2-15APS-1-WH	12	Plug-in appliance modules
EHD T832 C U 2 10	10	EcoSystem H-Series fluorescent dimming ballast - (2) T8 lamps <sup>1</sup>
EHD T832 C U 1 10	13	EcoSystem H-Series fluorescent dimming ballast - (1) T8 lamp <sup>1</sup>
–	–	Sivoia QS Wireless blackout shades <sup>2</sup>
<b>Materials cost: Contact Lutron for pricing</b>		

1 Ballasts typically purchased with fixtures. Price does not include cost of fixtures.

2 Contact Lutron Representative for shades model numbers and pricing.

**www.lutron.com**

World Headquarters 1.610.282.3800

Technical Support Center 1.800.523.9466 (Available 24/7)

Customer Service/Quotes 1.888.LUTRON1

© 05/2011 Lutron Electronics Co., Inc. | P/N 367-2114 REV A

