

## Maestro Wireless® Advanced Programming Mode (APM)

---

Maestro Wireless® dimmers contain APM features that allow the user to customize their control to meet their specific needs. This document serves as a supplement to the instruction sheet. APM features apply to only those products with M4 revision software or later while System Configuration Mode (SCM) features apply to those products with M6 revision software or later. Please note that the software revision level can be found on the outside of the unit and will always start with the letter M. Before entering either mode, it is important to have a good understanding of the features and further instructions, see the pages corresponding to your product.

### Dimmer

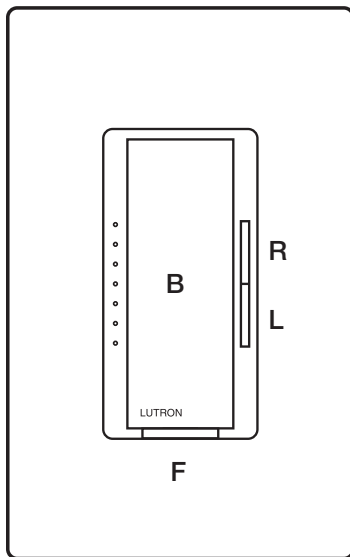

### Lamp Dimmer

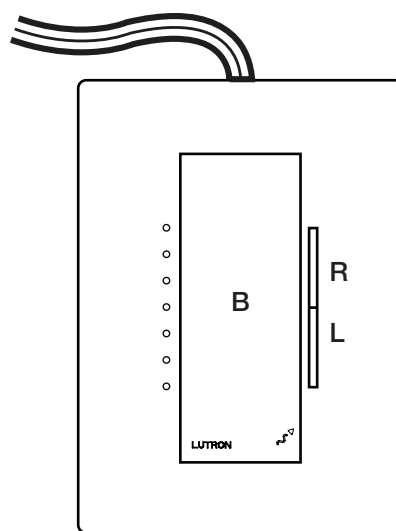

### Plug-In Dimmer

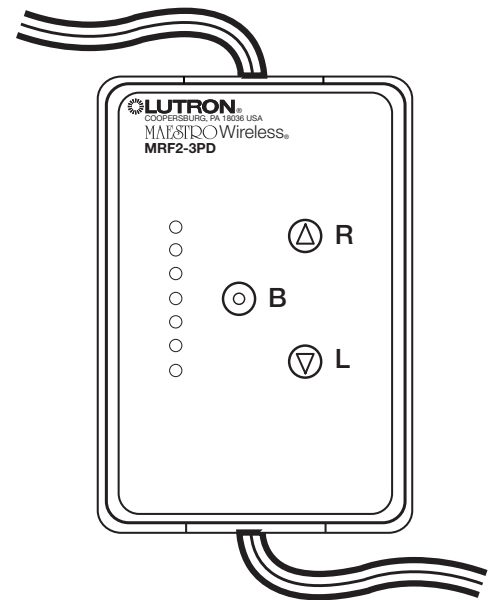

---

### Key

- B = Tap Button
- R = Raise Rocker
- L = Lower Rocker
- F = Front Accessible Service Switch (FASS™)  
Pull OFF/ Push ON

**Note:** The MRF2-3LD and MRF2-3PD products do not have a FASS™. In order to cycle power please follow the steps below:

1. Unplug the Maestro Wireless® device from the wall outlet.
2. Wait for 3 seconds.
3. Plug the Maestro Wireless® device into a standard wall outlet.

## Explanation of Advanced Dimmer Features

### ***Preset Options:***

The user has two options for the preset light level on the Dimmer: Locked Preset and Unlocked Preset.

**Locked Preset:** When programmed for a locked preset, the dimmer will always turn on to the predetermined “locked” level anytime the dimmer is turned on with a single tap of the Tap Button.

**Unlocked Preset:** When programmed for an unlocked preset, the dimmer will turn on to the light level that it was adjusted to the previous time that the light was on.

### ***“On” Fade Time:***

The user has options for how quickly the lights fade up when the dimmer is turned on. These options include fade times from off to maximum light output in as fast as 0.75 seconds and as slow as 15 seconds.

### ***“Off” Fade Time:***

The user has options for how quickly the lights fade down when the dimmer is turned off. These options include fade times from maximum light output to “Off” as fast as 0.75 seconds and as slow as 15 seconds.

### ***Set Delayed Fade-To-Off:***

The user has the option to set the waiting period upon fade-to-off.

### ***Set LED Brightness:***

The user has the option to dim or brighten the Maestro Wireless® LEDs to a high or low brightness setting.

### ***Set Low End Trim:***

The user has the option to set a minimum light level.

### ***Set High End Trim:***

The user has the option to set a maximum light level.

### ***Unaffected Dimmer/Switch:***

The user has the option of associating a Radio Powr Savr™ occupancy sensor to multiple Maestro Wireless® dimmers/switches, and set up the system so that only selected loads automatically turn on. Other loads would require the user to manually turn on the load. When the room is vacant, all loads turn off.

### ***System Configuration Options:***

The user has several options for the configuration of the system.

**Setting the Product Mode:** The user has the option to convert the dimmer to a switch when using CFL, Fluorescent or Electronic Low-Voltage (ELV) load types. Please note that this mode only applies to MRF2-3PD and MRF2-3LD products.

**Vacancy Light Level Preset:** The user has the option to set a preset light level when the space is vacant. This preset light level can be adjusted from the lowest light level to 50% of the load.

**Overriding Daylighting Timers:** The user has the option to override the normal operation of daylighting in the system when using a daylight sensor. By default when this option is disabled the override period is two hours for which the daylight sensor will have no impact. When this option is enabled the daylight sensor will continuously impact the lighting level regardless of user interaction.

**Overriding Daylighting Mode:** The user has the option to allow the daylight sensor to automatically turn the lights on without the need for an occupancy sensor when this option is enabled. By default the option is disabled and the lights will only turn on with a manual button press or an occupancy sensor input.

## Entering Main Menu Mode (refer to picture on Page 1.)

1. Pull the FASS™ into the “Off” Position.
2. Press and Hold the Tap Button of the product you are programming.
3. Push the FASS™ to the “On” Position while continuing to hold the Tap Button for approximately 5 seconds.  
The bottom LED will begin to blink to indicate that you have entered APM.

**Note:** If there is no activity for 1 minute, the dimmer will automatically exit APM.

## Entering Selection Menu Mode

1. **Press the Raise/Lower Rocker** to change the LED Position to indicate which feature you would like to modify (refer to picture below).

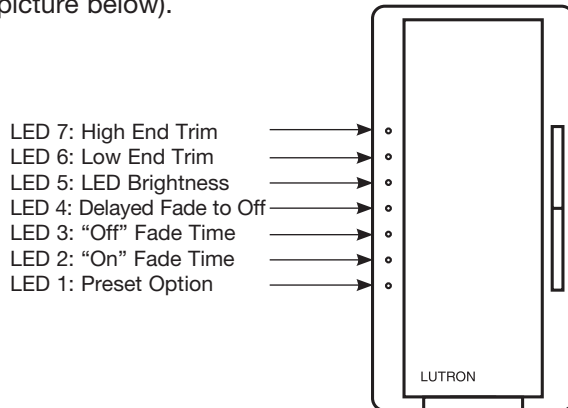

2. **Press the Tap Button** once and the feature will be selected for modification.

## Selecting a Preset Option

1. While in Main Menu Mode, **press the Raise/Lower Rocker** until LED 1 is blinking.
2. **Press the Tap Button** once.

### To select Locked Preset:

1. **Press the Raise/Lower Rocker** to adjust the light level to the desired Locked Preset. The quickly flashing LED will move up and down as the preset is changed. Your light will get brighter or dimmer to reflect the Locked Preset level as you adjust this feature.
2. **Press the Tap Button** once to return to the Main Menu.

### To select Unlocked Preset:

1. **Press the Lower Rocker** until the bottom LED is quickly flashing. Release the lower button and press and hold the lower button again for approximately 3 seconds or until LEDs 1, 2, and 3 start scrolling. Please note that the light will remain at its minimum output when you perform this action.
2. **Press the Tap Button** once to return to the Main Menu.

**Note:** The default setting is an Unlocked Preset. (Scrolling LEDs 1, 2, and 3)

## How to Save Settings and Exit Main Menu Mode

1. **Press and Hold the Tap Button** for 4 seconds to exit and save the Main Menu. **Note:** If you wait 1 minute the dimmer will automatically exit from APM, however settings will not be saved.

## Selecting the “On” Fade Time

1. While in Main Menu Mode, **press the Raise/Lower Rocker** until LED 2 is blinking.
2. **Press the Tap Button** once. A quickly flashing LED will indicate which fade time has been selected (refer to picture below). LED 1 is the default setting.
3. **Press the Raise/Lower Rocker** to adjust the quickly blinking LED to the position that represents the desired fade time.
4. **Press the Tap Button** once to return to the Main Menu.

**Note:** The default “On” Fade Time is 0.75 seconds. The fade speed for Raise and Lower operations are not affected by any “On” Fade Time modification.

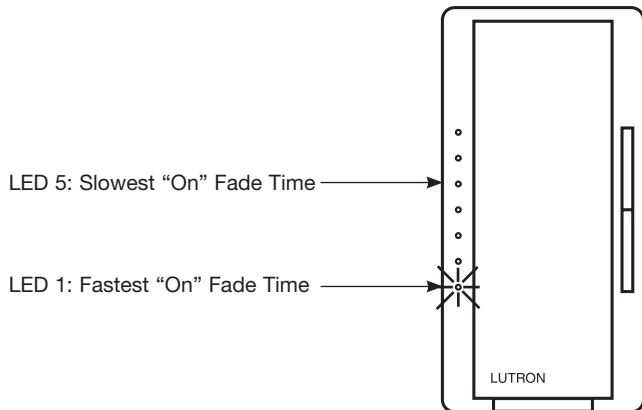

LED Position	“On” Fade Time* Single Tap	“On” Fade Time* Double Tap
5	15 seconds	5 seconds
4	5 seconds	3 seconds
3	3 seconds	2.5 seconds
2	2.5 seconds	0.75 seconds
1	0.75 seconds	0.75 seconds

\*Time from Off to Maximum light level.

## Selecting the “Off” Fade Time

1. While in Main Menu Mode, **press the Raise/Lower Rocker** until LED 3 is blinking.
2. **Press the Tap Button** once. A quickly flashing LED will indicate which fade time has been selected (refer to picture below). LED 2 is the default setting.
3. **Press the Raise/Lower Rocker** to adjust the quickly blinking LED to the position that represents the desired fade time.
4. **Press the Tap Button** once to return to the Main Menu.

**Note:** The default “Off” Fade Time is 2.5 seconds. The fade speed for Raise and Lower operations are not affected by any “Off” Fade Time modification.

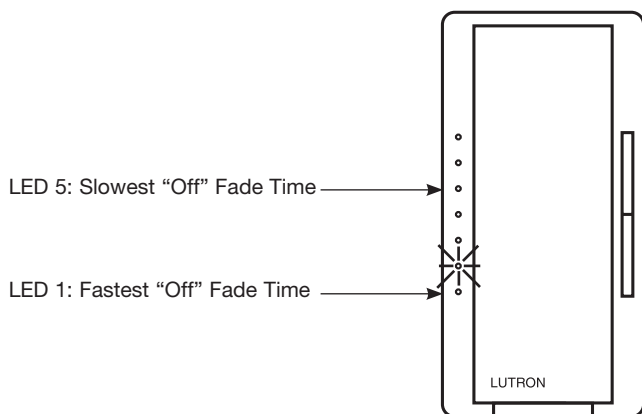

LED Position	“Off” Fade Time*
5	15 seconds
4	5 seconds
3	3 seconds
2	2.5 seconds
1	0.75 seconds

\*Time from Maximum light level to Off.

## How to Save Settings and Exit Main Menu Mode

1. **Press and Hold the Tap Button** for 4 seconds to exit and save the Main Menu. **Note:** If you wait 1 minute the dimmer will automatically exit from APM, however settings will not be saved.

## Setting Delayed Fade-To-Off

1. While in Main Menu Mode, **press the Raise/Lower Rocker** until LED 4 is blinking.
2. **Press the Tap Button** once.
3. **Press the Raise/Lower Rocker** to adjust the waiting period. Each LED is equal to 10 seconds.  
Examples; LED 4 is equal to 40 seconds; LED 2 is equal to 20 seconds
4. **Press the Tap Button** once to return to Main Menu Mode.

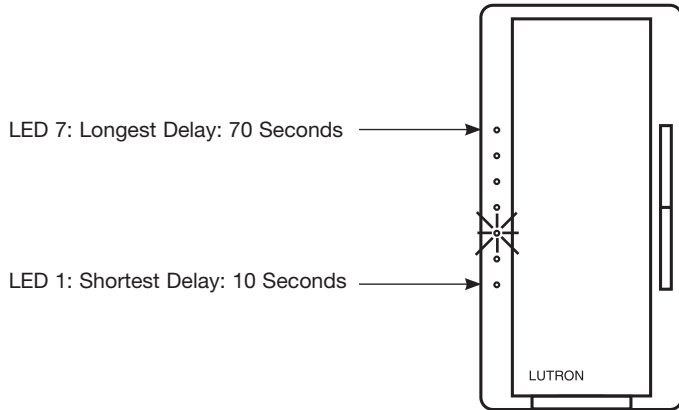

LED Position	Delayed Fade-To-Off Time
7	70 seconds
6	60 seconds
5	50 seconds
4	40 seconds
3	30 seconds (Default)
2	20 seconds
1	10 seconds

## Selecting LED Brightness

1. While in Main Menu Mode, **press the Raise/Lower Rocker** until LED 5 is blinking.
2. **Press the Tap Button** once.
3. **Press the Raise/Lower Rocker** to adjust to the desired brightness. (High or Low)
4. **Press the Tap Button** once to return to the Main Menu Mode.

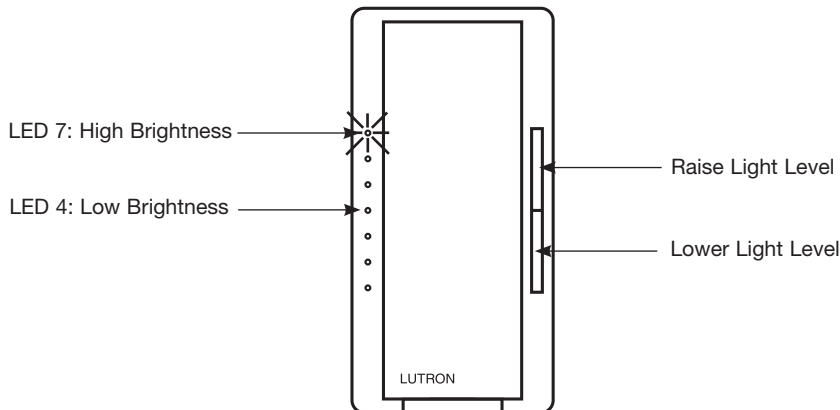

## How to Save Settings and Exit Main Menu Mode

1. **Press and Hold the Tap Button** for 4 seconds to exit and save the Main Menu. **Note:** If you wait 1 minute the dimmer will automatically exit from APM, however settings will not be saved.

## Setting Low End Trim

Adjusting low end trim changes the minimum light level that is reached when in normal operation, the dimmer is off, and the raise button is pressed once. The range of this adjustment is limited to the bottom 3 LEDs.

1. While in Main Menu Mode, **press the Raise/Lower Rocker** until LED 6 is blinking.
2. **Press the Tap Button** once.
3. **Press the Raise/Lower Rocker** to adjust to the desired minimum light level. Please note that any incremental or decremental steps between LEDs will cause the percentage of the load to vary between the percentages listed in the table below.
4. **Press the Tap Button** once to return to the Main Menu Mode.

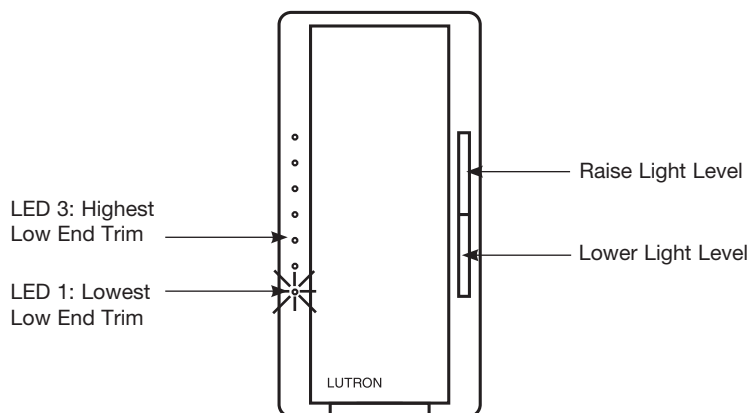

LED Position	Low End Trim*
3	~ 26–35% of dim range
2	~ 13–25% of dim range
1	~ 1–12% of dim range

\*Values are for reference only; actual values may vary.

## Setting High End Trim

Adjusting high end trim lower will increase the bulb life and reduce energy consumption, while raising it can achieve greater light output and a fuller range of dimming. This adjustment limits the dimmer's maximum output level during normal operation. The range of this adjustment is limited to the top 3 LEDs. When making adjustments to meet lamp life requirements or energy saving, it is best to have either a voltmeter or power meter available. An alternate approach is to reduce light level to a point where it just meets the maximum light level needs of the space; this can be achieved by observation or a light meter.

1. While in Main Menu Mode, **press the Raise/Lower Rocker** until LED 7 is blinking.
2. **Press the Tap Button** once.
3. **Press the Raise/Lower Rocker** to adjust to the desired maximum light level. Please note that any incremental or decremental steps between LEDs will cause the percentage of the load to vary between the percentages listed in the table below.
4. **Press the Tap Button** once to return to the Main Menu Mode.

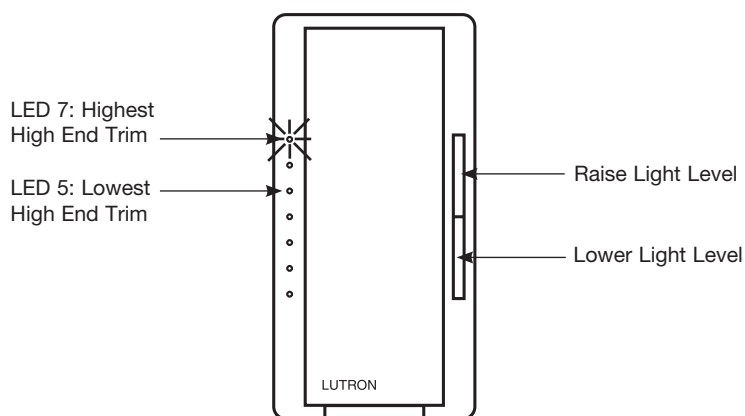

LED Position	High End Trim*
7	~ 90–100% of dim range (default)
6	~ 75–89% of dim range
5	~ 65–74% of dim range

\*Values are for reference only; actual values may vary

## How to Save Settings and Exit Main Menu Mode

1. **Press and Hold the Tap Button** for 4 seconds to exit and save the Main Menu. **Note:** If you wait 1 minute the dimmer will automatically exit from APM, however settings will not be saved.

## Entering System Configuration Mode (SCM) Menu

1. While in Main Menu Mode, **press the Raise Rocker** until LED 7 begins to blink then release. **Press and hold the Raise Rocker** again for 3 seconds. LEDs 1 and 3 will begin to blink, requiring confirmation to enter SCM.

**Note:** Upon entering SCM the product cannot be returned to the Main Menu Mode until APM has been exited by performing power cycling or pressing and holding the Tap Button. To exit at any point simply power cycle the product.

2. **Press the Tap Button** on the product once to enter SCM. LED 7 and a user selectable LED will begin to blink.

**Note:** If a menu item does not pertain to the product the menu item will not be available for selection.

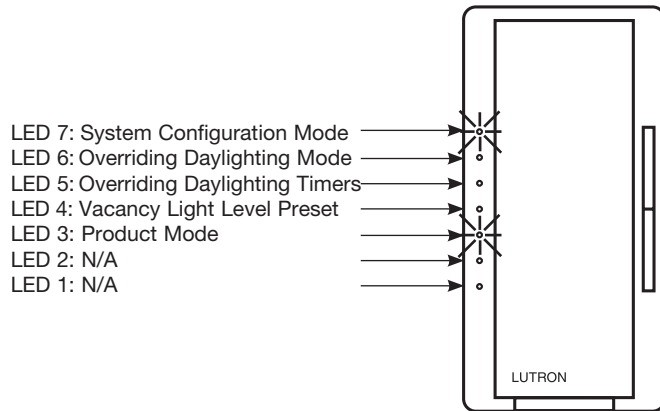

### Adjusting Product Mode (Available for Corded Dimmers with M6 software or later only):

1. **Press the Raise/Lower Rocker** until LED 3 begins to blink.  
**Note:** LED 7 will also be blinking indicating that the product is in SCM.
2. **Press the Tap Button** once in order to determine the current mode of the product. An LED will begin to blink quickly indicating the current mode of the product.
3. **Press the Raise/Lower Rocker** to adjust the mode of the product. The position of the quickly blinking LED will move indicating the selected mode of the product.
4. **Press the Tap Button** once to return to the SCM.

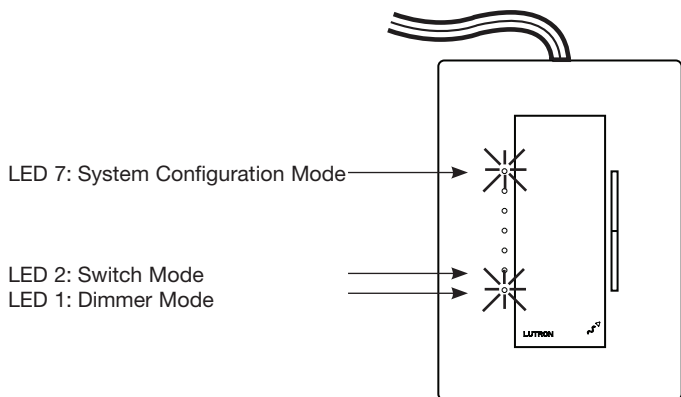

LED Position	Mode Type
2	Switch Mode
1	Dimmer Mode (Default)

**Note:** Alternatively the user may triple tap the Tap Button and hold for 30 seconds to cycle between the switch and dimmer modes without the need to enter APM.

### How to Save Settings and Exit SCM

1. **Press and Hold the Tap Button** for 4 seconds to exit and save the APM. **Note:** If you wait 1 minute the dimmer will automatically exit from APM, however settings will not be saved.

**Vacancy Light Level Preset (Available for products with M6 revision software or later):**

1. **Press the Raise/Lower Rocker** until LED 4 begins to blink.  
**Note:** LED 7 will also be blinking indicating that the product is in SCM.
2. **Press the Tap Button** once in order to determine the current preset setting. An LED will begin to blink quickly indicating the current preset setting.
3. **Press the Raise/Lower Rocker** to adjust the preset setting. The position of the quickly blinking LED will move indicating the selected preset setting. Please note that any incremental or decremental steps between LEDs will cause the percentage of the load to vary between the percentages listed in the table below. In order to set the preset to off **press the Raise/Lower Rocker** until LED 1 begins to blink then release. Next **press the Raise/Lower Rocker** and continue holding for a period of five seconds. LEDs 1, 2 and 3 will begin scrolling indicating that the preset has been set to off.
4. **Press the Tap Button** once to return to the SCM Menu.

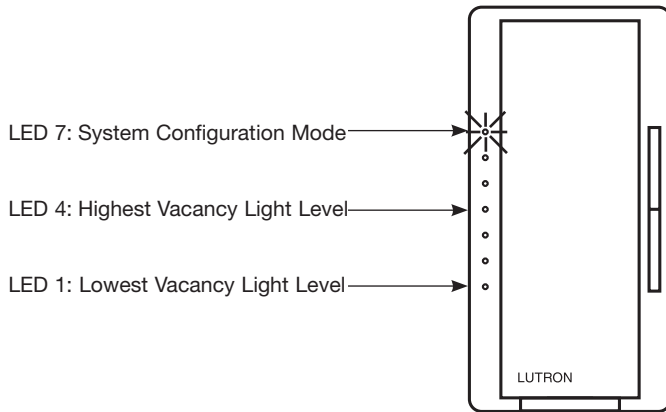

LED Position	Vacancy Light Level Preset
4	50% of Load
3	34% of Load
2	17% of Load
1	1% of Load
Scrolling 1, 2, 3	Off (Default)

**To Unlock the Vacancy Light Level Preset:**

1. **Press the Lower Rocker** until the bottom LED is quickly flashing. Release the lower button and press and hold the lower button again for approximately 3 seconds or until LEDs 1, 2, and 3 start scrolling. Please note that the light will remain at its minimum output when you perform this action.
2. **Press the Tap Button** once to return to the SCM Menu.

**How to Save Settings and Exit SCM**

1. **Press and Hold the Tap Button** for 4 seconds to exit and save the APM. **Note:** If you wait 1 minute the dimmer will automatically exit from APM, however settings will not be saved.



**Overriding Daylight Timers (Available for products with M6 revision software or later):**

1. **Press the Raise/Lower Rocker** until LED 5 begins to blink.  
**Note:** LED 7 will also be blinking indicating that the product is in SCM.
2. **Press the Tap Button** once in order to determine the current override setting. An LED will begin to blink quickly indicating the current override setting.
3. **Press the Raise/Lower Rocker** to adjust the override setting. The position of the quickly blinking LED will move indicating the selected override setting.
4. **Press the Tap Button** once to return to the SCM Menu.

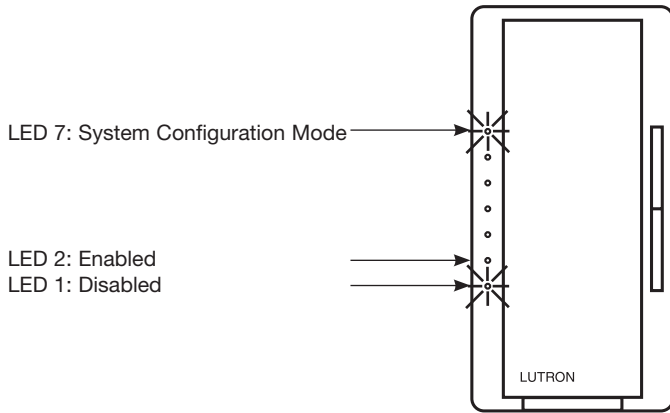

LED Position	Override Daylight Timers
2	Enabled
1	Disabled (Default)

**Overriding Daylighting Mode (Available for products with M6 revision software or later):**

1. **Press the Raise/Lower Rocker** until LED 6 begins to blink.  
**Note:** LED 7 will also be blinking indicating that the product is in SCM.
2. **Press the Tap Button** once in order to determine the current override setting. An LED will begin to blink quickly indicating the current override setting.
3. **Press the Raise/Lower Rocker** to adjust the override setting. The position of the quickly blinking LED will move indicating the selected override setting.
4. **Press the Tap Button** once to return to the SCM Menu.

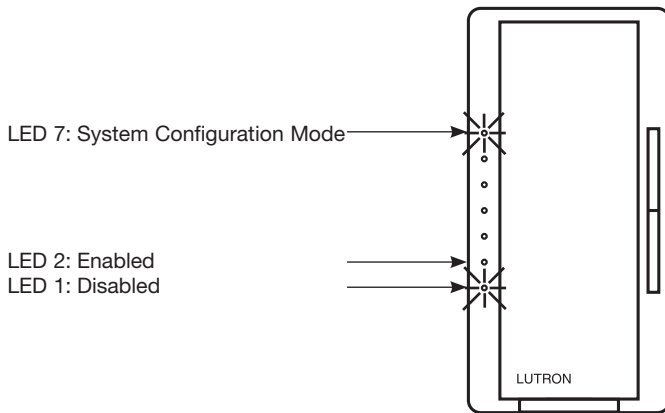

LED Position	Daylighting
2	Enabled
1	Disabled (Default)

**How to Save Settings and Exit SCM**

1. **Press and Hold the Tap Button** for 4 seconds to exit and save the APM. **Note:** If you wait 1 minute the dimmer will automatically exit from APM, however settings will not be saved.

## Restoring Factory Defaults

If you would like to return the dimmer/switch to its original factory settings, please do the following:

### Restoring Factory Defaults

#### Dimmer/Switch

**Note:** If the dimmer/switch is restored to factory defaults, not only will the APM settings return to default settings, but any Pico® wireless controllers, occupancy, vacancy, and daylight sensors will no longer be associated to the dimmer/switch.

- a. Press the Tap Button three times in quick succession and hold on the third press. Continue to hold the Tap Button until the LED(s) and Load begin to cycle.
- b. Quickly press the Tap Button three more times in quick succession and release after the third press.
- c. **Confirmation:** The LED(s) and Load will cycle three times then turn on.

**Note:** The Tap Button **MUST** continue to be held until the second sequence of three presses is begun or the unit will exit the mode and the procedure **WILL NOT** be successful.

#### Removing One Transmitter from Specific Dimmers/Switches within Range

**Note:** If the transmitter is associated with multiple devices, any device within listening range will also remove its association to that particular transmitter.

- a. To avoid dissociation of the transmitter from any device within listening range, **pull the FASS™** of that device into the “Off” Position or **Unplug the Maestro Wireless® device** from the wall outlet.
- b. **Press the “On” Button** on the transmitter three times in quick succession and continue holding the button on the third press. Please refer to the transmitter’s instructions for the appropriate response.
- c. Test the transmitter to verify that all of the appropriate devices have been dissociated from the transmitter.
- d. Upon confirming success in the previous step, **push the FASS™** into the “On” Position or **Plug the Maestro Wireless® device** into a standard wall outlet for any remaining devices with an association to the transmitter.

## Setting Unaffected Mode

The user has the option of associating a Radio Powr Savr™ occupancy sensor to multiple Maestro Wireless® dimmers/switches, and set up the system so that only selected loads automatically turn on. Other loads would require the user to manually turn on the load. When the room is vacant, all loads turn off.

### Selecting the Unaffected Dimmer\*

1. Turn off the dimmer.
2. **Press the Lower Rocker Button** for 3 seconds or until the middle three LEDs illuminate.
3. **Press and hold the “Test” Button** on the Radio Powr Savr™ occupancy sensor until the dome flashes.

### Selecting the Unaffected Switch\*

1. Turn off the switch.
2. **Pull the FASS™** into the “Off” Position.
3. **Press and Hold the Tap Button** of the product while **pushing the FASS™** to the “On” Position until the LED on the switch starts to blink.
4. **Press and hold the “Test” Button** on the occupancy sensor until the dome flashes.

\* Does not require entering into Main Menu Mode or SCM.

## Lutron Contact Numbers

### **WORLD HEADQUARTERS USA**

**Lutron Electronics Co., Inc.**  
7200 Suter Road  
Coopersburg, PA 18036-1299  
TEL: +1.610.282.3800  
FAX: +1.610.282.1243  
Toll-Free: 1.888.LUTRON1  
Technical Support: 1.800.523.9466  
intsales@lutron.com

### **North & South America Technical Hotlines**

**USA, Canada, Caribbean:**  
1.800.523.9466  
**Mexico:**  
+1.888.235.2910  
**Central/South America:**  
+1.610.282.6701

### **EUROPEAN HEADQUARTERS United Kingdom**

**Lutron EA Ltd.**  
6 Sovereign Close  
London, E1W 3JF United Kingdom  
TEL: +44.(0)20.7702.0657  
FAX: +44.(0)20.7480.6899  
FREEPHONE (UK): 0800.282.107  
Technical Support: +44.  
(0)20.7680.4481  
lutronlondon@lutron.com

### **ASIAN HEADQUARTERS Singapore**

**Lutron GL Ltd.**  
15 Hoe Chiang Road  
#07-03, Tower 15  
Singapore 089316  
TEL: +65.6220.4666  
FAX: +65.6220.4333  
Technical Support: 800.120.4491  
lutronsea@lutron.com

### **Asia Technical Hotlines**

Northern China: 10.800.712.1536  
Southern China: 10.800.120.1536  
Hong Kong: 800.901.849  
Indonesia: 001.803.011.3994  
Japan: +81.3.5575.8411  
Macau: 0800.401  
Taiwan: 00.801.137.737  
Thailand: 001.800.120.665853  
Other Countries: +65.6220.4666