



MasterColor CDM-R111 35W/830 40D 1CT

Product family description

Philips MasterColor® CDM-R111 combines the trendy look of the 111 mm aluminum reflector halogen lamps with the long life, high energy efficiency and crisp whitelight of ceramic metal halide MasterColor lamps.

Features

- 38W CDM-R111 lasts 3 times longer than 75W Aluline Pro 111 lamps
- 38W CDM-R111 uses less than half the energy used compared to 75W Aluline Pro 111 lamps
- Excellent color quality
- 20,35,70 Watt FI ,NFL, and Spot 830K versions

Benefits

- Energy efficient with long life
- Crisp white light in contemporary design

Application

- Ideal for accent/decorative lighting, general lighting, and downlighting in retail applications

Notes

- R "WARNING: These lamps can cause serious skin burn and eye inflammation from short wave ultraviolet radiation if outer envelope of the lamp is broken or punctured. Do not use where people will remain for more than a few minutes unless adequate shielding or other safety precautions are used. Certain lamps that will automatically extinguish when the outer envelope is broken or punctured are commercially available." This lamp complies with FDA radiation performance standard 21 CFR subchapter J. (USA:21 CFR 1040.30 Canada: SOR/DORS/80-381)
- Requires a ballast specified or approved for Philips Metal Halide lamp or one designed to the indicated ANSI Standard. A pulse ignitor is required. Sockets and wiring must withstand starting pulse. (391)

PHILIPS

- Supply volts must be +/- 5% of rated ballast line volts for reactor type and +/- 10% for CWA or electronic ballasts. (392)
- UV filtered design (FadeBlock™). (396)
- Operate only on thermally protected ballasts (397)
- MasterColor® Metal Halide Lamps are not recommended for use on dimmers and are not warranted if used on dimmer systems. (401)
- Rated average life is the life obtained, on the average, from large representative groups of lamps in laboratory tests under controlled conditions at 10 or more operating hours per start. It is based on survival of at least 50% of the lamps and allows for individual lamps or groups of lamps to vary considerably from the average. For lamps with a rated average life of 24,000 hours, life is based on survival of 67% of the lamps. (351)
- Approximate lumen values listed are for vertical operation of the lamp. (352)
- Heat resisting glass bulb.
- Exclusive to Philips Lighting Company.

Product data	
Product Number	139212
Full product name	MasterColor CDM-R111 35W/830 40D ICT
Ordering Code	139212
Pack type	1 Lamp in a Folding Carton
Pieces per Sku	1
Skus/Case	6
Pack UPC	046677139216
EAN2US	
Case Bar Code	50046677139211
Successor Product number	
Base	GX8.5
Bulb	R111 [R 111mm]
Bulb Finish	Reflector
Operating Position	Universal [Any or Universal (U)]
Packing Type	ICT [1 Lamp in a Folding Carton]
Packing Configuration	6
Avg. Life	7500 hr
Avg. Hrs. Life	11000 hr
Ordering Code	CDM-R111 35W/830 40DG
Pack UPC	046677139216
Case Bar Code	50046677139211
ANSI Code HID	M130/O
System Power EL	44 W
Watts	35W
Lamp Wattage EL	39 W
Lamp Voltage	88 V
Dimmable	No
Beam Description	Flood [Flood]
Beam Angle	40D
Approx. MBCP	4000 cd



Product data	
Color Code	830 [CCT of 3000K]
Color Rendering Index	81 Ra8
Color Designation	Warm White
Color Description	830 Warm White
Color Temperature	3000 K
Initial Lumens	1350 Lm
Design Mean Lumens	- Lm
Overall Length C	95 mm
Diameter D	111 mm
Max Overall Length (MOL) - C	3.75 in
Product Number	139212



CDM-R111 24D/40D



Base GX8.5

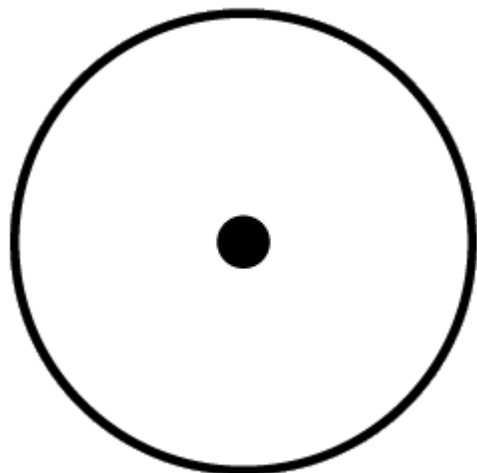

Operating Position Universal

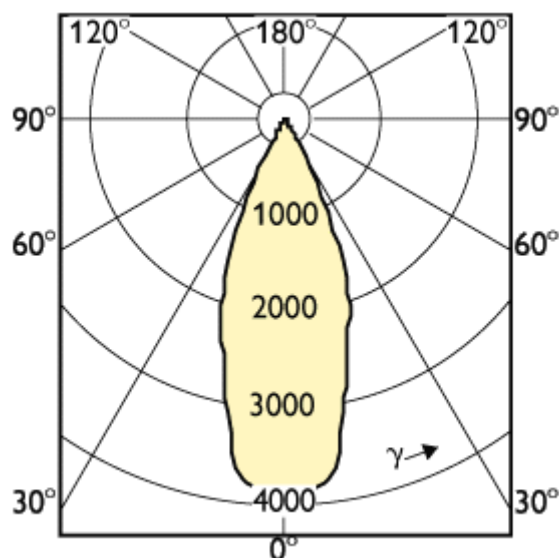

CDM-R111 35W 40D

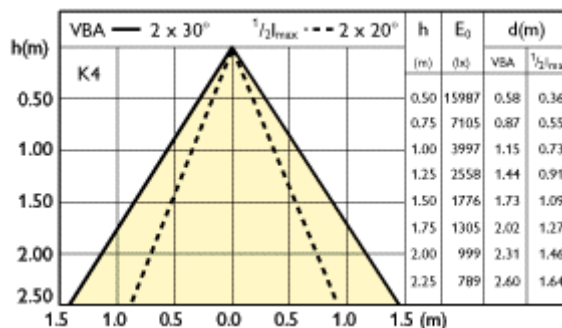
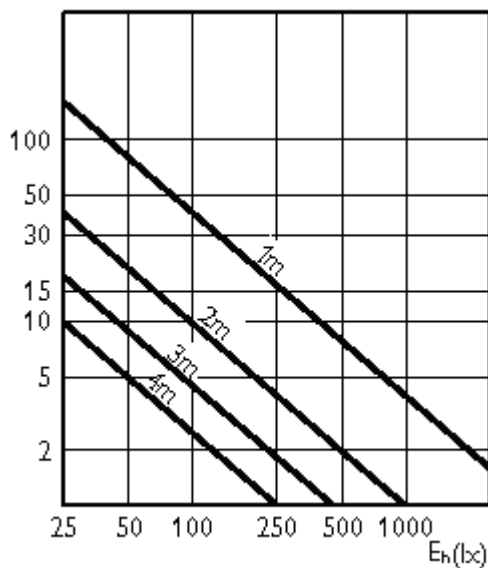

CDM-R111 35W 40D

CDM-R111 35W 40D

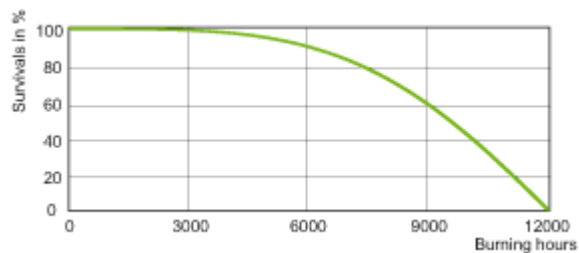

on electronic gear

CDM-R111 35W/830

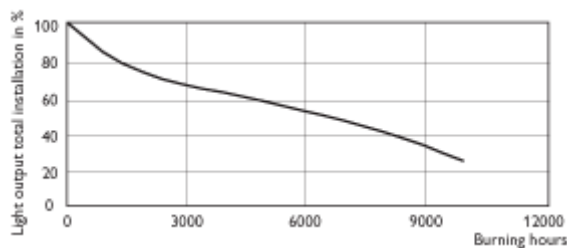

on electronic gear

CDM-R111 35W/830

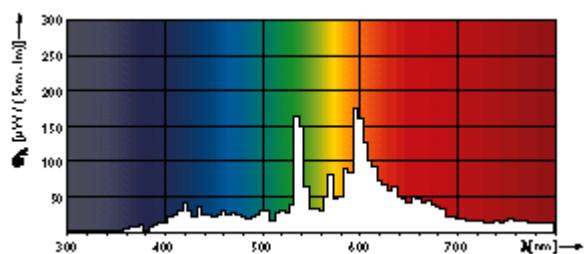

MASTERColour CDM-R111/830

CDM-R111/830

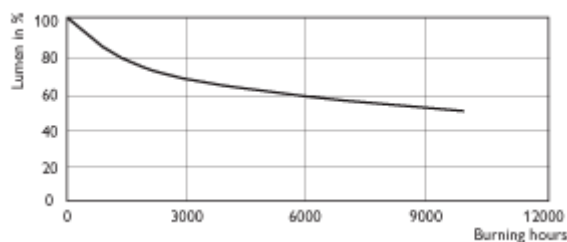

on electronic gear

CDM-R111 35W/830

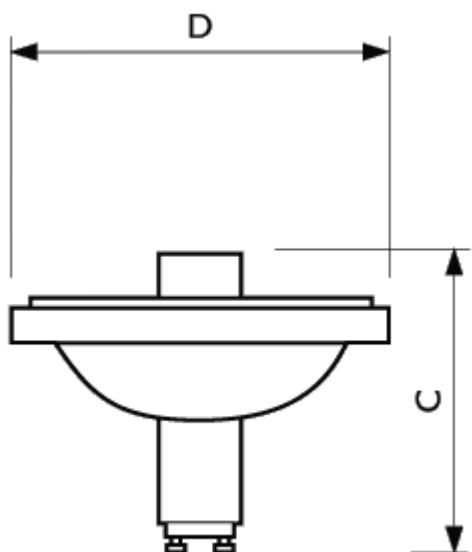

CDM-R111 GX8.5

	C	D
Full product name	Max	Max
MasterColor CDM-R111 35W/830 40D ICT	95	111



©2009 Koninklijke Philips Electronics N.V.

All rights reserved. Reproduction in whole or in part is prohibited without the prior written consent of the copyright owner. The information presented in this document does not form part of any quotation or contract, is believed to be accurate and reliable and may be changed without notice. No liability will be accepted by the publisher for any consequence of its use. Publication thereof does not convey nor imply any license under patent- or other industrial or intellectual property rights.

Document order number : 0000 000 00000