



PL-T 26W/841/4P 1CT

Product family description
PL-T Triple 4pin Fluorescent Lamp with Amalgam.

Features/Benefits

- ALTO® Lamp Technology - Passes EPA's TCLP test for non-hazardous waste.
- Utilizes amalgam technology to provide > 90% of rated lumens in ambient temperatures from 23F to 130F.
- Triple tube design available in 18, 26, 32, and 42W.
- Excellent Color Rendering - 82 Color Rendering Index (CRI).
- Broad Range of Color Temperature - Available in 2700, 3000, 3500 and 4100K.
- Dimmable - PL-T 4-pin lamps may be used with electronic dimming ballasts.
- Long Life - 12,000 hours.
- Energy Saving - Designed for use with electronic ballasts for lower operating costs and flicker-free starting.

Applications

- Ideal for downlights and medium bay multi-lamp fixtures for general lighting.

Notes

- Rated average life under specified test conditions with lamps turned off and restarted no more frequently than once every 3 operating hours. Lamp life is appreciably longer if lamps are started less frequently. (202)
- Approximate Initial Lumens. The lamp lumen output is based upon lamp performance after 100 hours of operating life, when the output is measured during operation on a reference ballast under standard laboratory conditions. (203)
- Design Lumens are the approximate lamp lumen output at 40% of the lamp's Rated Average Life. This output is based upon measurements obtained during lamp operation on a reference ballast under standard laboratory conditions. (208)

Product data

Product Number	268250
Full product name	PL-T 26W/841/4P 1CT
Ordering Code	268250
Pack type	1 Lamp in a Folding Carton
Pieces per Sku	1
Skus/Case	12
Pack UPC	046677268251
EAN2US	

Product data	
Case Bar Code	50046677268256
Successor Product number	
Base	GX24q-3
Base Information	4P
Execution	/4P [4 Pins]
Packing Type	1CT [1 Lamp in a Folding Carton]
Packing Configuration	12
Avg. Hrs. Life	16000 hr
Ordering Code	PL-T 26W/841/4P/ALTO
Pack UPC	046677268251
Case Bar Code	50046677268256
Watts	26W
Lamp Voltage	105 V
Dimmable	Yes
Color Code	840 [CCT of 4000K]
Color Rendering Index	82 Ra8
Color Designation	Cool White
Color Description	840 Cool White
Color Temperature	4000 K
Initial Lumens	1800 Lm
Initial Lumens	1800 Lm
Overall Length C	126.4 mm
Diameter D	39.85 mm
Diameter D1	39.65 mm
Product Number	268250



PL-T 26W

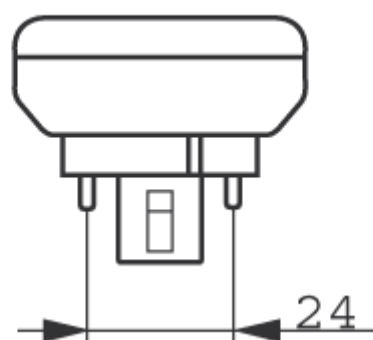
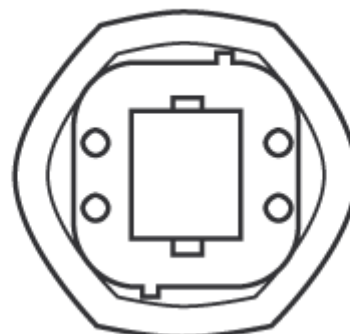

Base GX24q-3

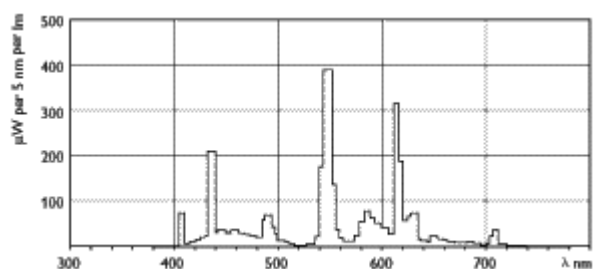

PL-T/840

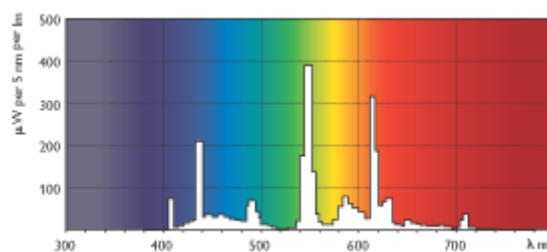

PL-T/840

