

LED Corn Bulb Lamp Series



5 Years Warranty



Specifications

Model	PLT-1103
Rate Power	10W
Input Voltage	AC100-277V 50-60Hz
CCT	5000K
Power Factor	≥0.9
CRI	>80
Lumen	1180lm
Chips	Samsung
LED Quantity	32LEDs 0.3W
LED LM80	Yes



Samsung LM561B



Rubycon



E26



JAE Connector

Dimension

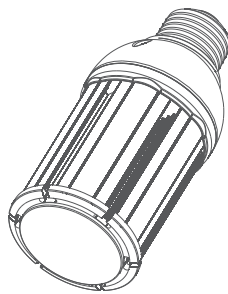
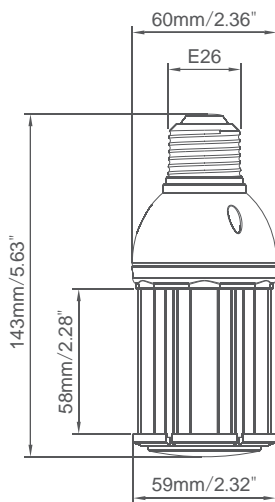

Luminous emittance

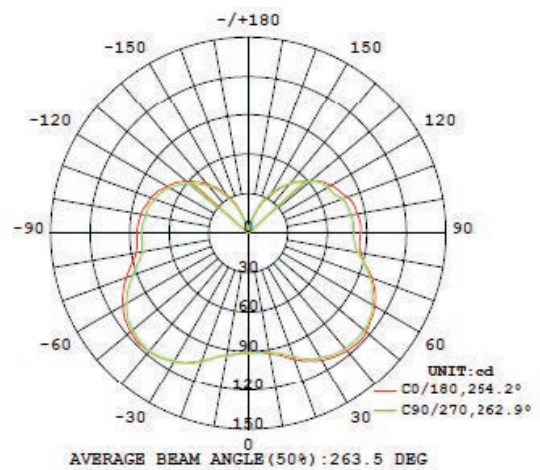

Long Lifespan of 10years

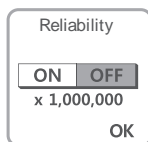

Reliability Test

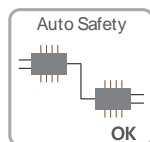

Safety Protection Circuit

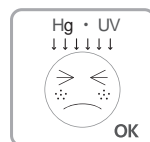

No Mercury
No UVLight

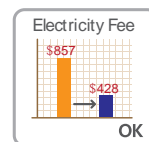

Big Saving(87%)
on Electricity Costs

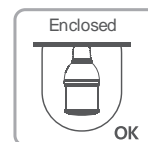

Usable in Enclosed
Luminaires

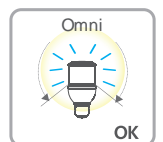

Omni Wide Angle

Installation

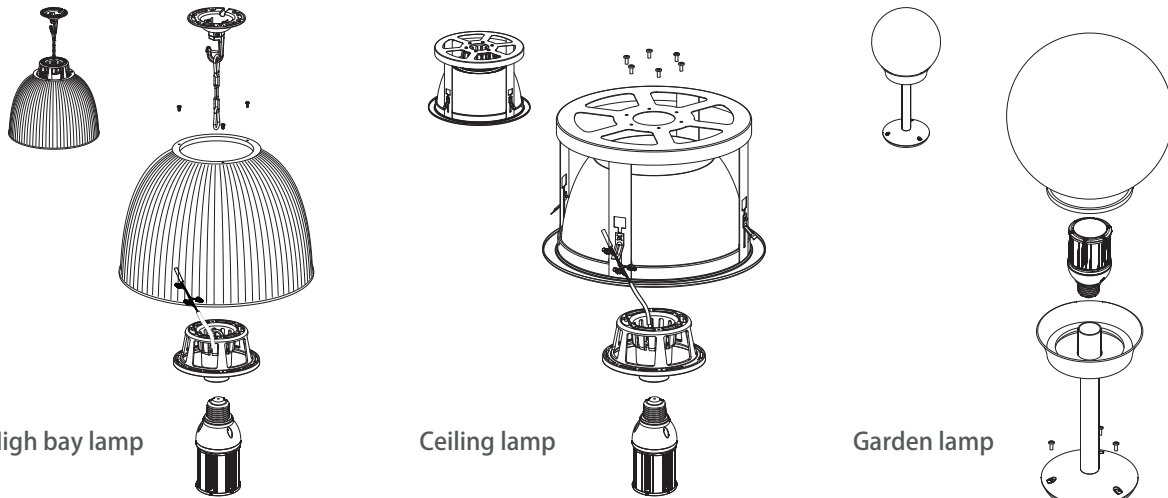

High bay lamp

Ceiling lamp

Garden lamp

Absolute Maximum Rating

Parameter	Rating	Units
Aluminum Heat Sink Temperature	52	° C
Operating Temperature	-20~+65	° C
Storage Temperature	-40~+80	° C
Equilibrium Temperature	25	° C

Label

LED Corn Bulb lamp
Model:PLT-1103
AC100-277V 50-60Hz
Power:10W CCT:5000K

LED Corn Bulb lamp
Model:PLT-1103
AC100-277V 50-60Hz
Power:10W CCT:5000K

Product Packing Specification

Packing Details	
Pack Quantity	48pcs
Net Weight	0.55lbs/248g
Gross Weight Per CTN	32.19lbs/14.6kg
Box Size	73*73*171mm
CTN Size	460*310*362mm

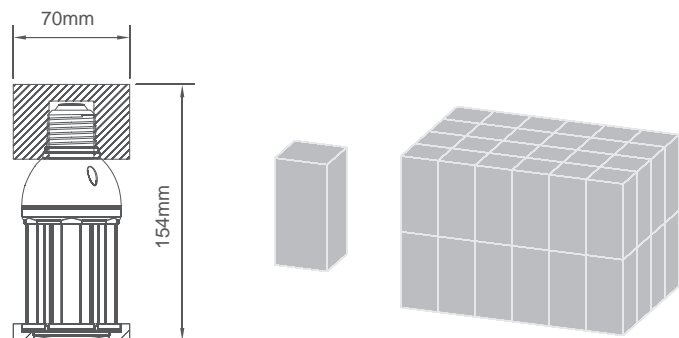

⚠ CAUTIONS

- Make sure remove the traditional ballast before replace the LED corn light.
- Don't take apart the product or replace mechanical and electronic components.
- Don't stare at the strong light for a long time as it may cause injury to eyes.