

LED Corn Bulb Lamp Series



5 Years Warranty



Specifications

Model	PLT-8103
Rate Power	120W
Input Voltage	AC100-277V 50-60Hz
CCT	5000K
Power Factor	≥0.9
CRI	>80
Lumen	15020lm
Chips	Samsung
LED Quantity	336LEDs 0.3W
LED LM80	Yes



Samsung LM561B



Rubycon



E39



JAE Connector

Dimension

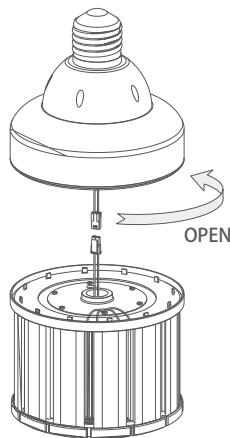
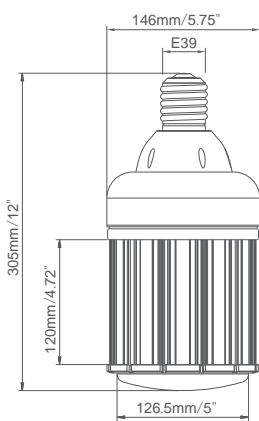

Luminous emittance

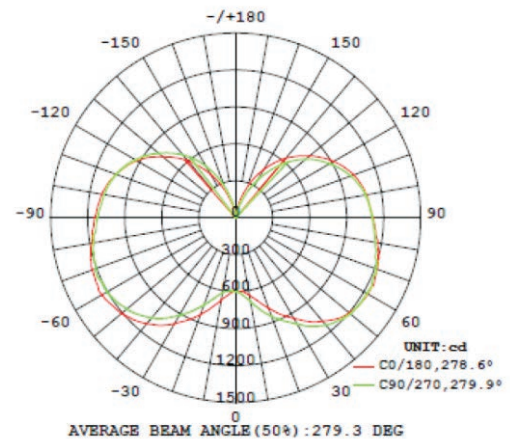

Long Lifespan of 10years

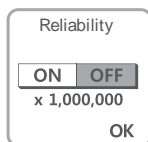

Reliability Test

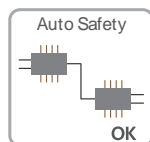

Safety Protection Circuit

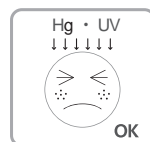

No Mercury
No UVLight

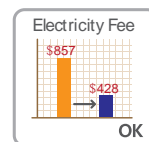

Big Saving(87%)
on Electricity Costs

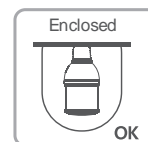

Usable in Enclosed
Luminaires



Omni Wide Angle

Installation

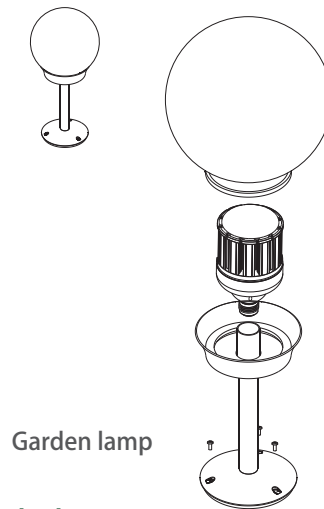

Absolute Maximum Rating

Parameter	Rating	Units
Aluminum Heat Sink Temperature	65	° C
Operating Temperature	-20~+50	° C
Storage Temperature	-40~+80	° C
Equilibrium Temperature	25	° C

Label

LED Corn Bulb lamp
Model:PLT-8103
AC100-277V 50-60Hz
Power: 120W
CCT:5000K

LED Corn Bulb lamp
Model:PLT-8103
AC100-277V 50-60Hz
Power: 120W
CCT:5000K

Product Packing Specification

Packing Details	
Pack Quantity	4pcs
Net Weight	4lbs/1828g
Gross Weight Per CTN	19.8lbs/9kg
Box Size	185*185*337mm
CTN Size	385*385*357mm

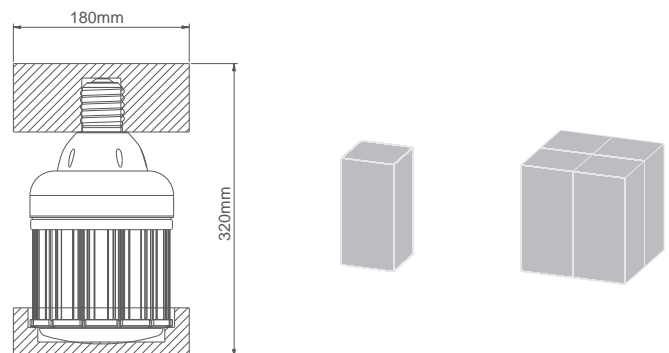

⚠ CAUTIONS

- Make sure remove the traditional ballast before replace the LED corn light.
- Don't take apart the product or replace mechanical and electronic components.
- Don't stare at the strong light for a long time as it may cause injury to eyes.