

# SUPER STEALTH

## Installation Manual



The STEALTH360 is the most reliable and technically advanced motion-activated light control ever produced. This technical manual is written for electrical professionals who wish to maximize the performance and reliability of this superb sensor.

RAB welcomes your questions or comments. Please call 888 722-1000, or email [tech@rabweb.com](mailto:tech@rabweb.com). Thank you for purchasing a RAB sensor.



STL360HBW



STL360Q1



STL360H



STL360Q3W



STL360Q2W

# RAB

## Specifications:

<b>Switching Capacity</b>	8 amps 1000 watts Incandescent and 250 watts Fluorescent
<b>Voltage:</b>	120 volts
<b>Protection Pattern:</b>	180° forward 360° below and to all sides
<b>Time Adjustment:</b>	5 seconds to 12 minutes
<b>Power Consumption:</b>	1 watt
<b>Surge protection:</b>	6000 volts



---

## Cautions:

TURN OFF ALL POWER AT CIRCUIT BREAKER / FUSE PANEL.

- Read entire Installation Manual before proceeding.
- All wiring should comply with local electrical codes and requires a qualified electrician.
- The total lighting load connected to STL360 must not exceed (1000 watts incandescent or quartz, 250 watts fluorescent). To switch more wattage an electrician can install a relay.
- Line Carrier Remote Control Systems such as X-10, Leviton or Radio Shack are incompatible with sensors and may cause false activations.
- Do not install sensors on a circuit that feeds motor loads such as kitchen appliances, HVAC equipment, washer/dryer, or garage door openers.
- Sensor functions best when the direction of expected movement is across its detection pattern, not towards the sensor.
- Mount 6'-12' high for optimum range and detection.

## How Does the Super Stealth 360 Work?

The STL360's infrared sensor "sees" temperature changes caused by the motion of people or cars within its protection zone and turns on lights automatically. It welcomes visitors and may deter intruders.

### Total coverage. Two sensors in one.

Two powerful detectors combine to give the STL360 "Can't Miss" Detection: 180° long forward range (180° x 60') plus superb 360° detection below and to all sides.



### How do the scanning LED detection indicators work?

Scanning LEDs serve as a deterrent by indicating a security device in operation. They also show the STL360's mode of operation:

**On Guard:** When the STL360 is "On Guard" in Auto mode, three red LEDs scan continuously day and night, except during detections (at which time the controlled lights will go on).



**Test Mode:** When the sensor is in "Test Mode" all the LEDs will be off. If the sensor is set for night-only operation, the LED stays "On Guard" (daytime detections do not turn on the lights).

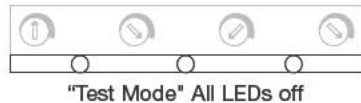

**Manual Override Mode:** In "Manual Override Mode," the middle LED will be on. (see page 14)



### How long do the lights stay on?

Lights remain on as long as there is movement within the protection zone. Once the zone is vacated lights can be adjusted to remain on from approximately 5 seconds up to 12 minutes. Since the lights are on only when needed, and the sensor uses only one watt, the STL360 is extremely energy efficient.

### Can lights still be turned on with the light switch?

Yes. STL360 can be controlled by a conventional indoor switch or circuit breaker. The STL360 operates in Auto Mode unless changed. The light can be turned on or off manually at night only. (see pages 13-14 for more info.)

#### ■ Manual Override Mode (to keep lights on):

Flip the switch twice slowly (off-on-off-on) within 1-2 secs.

■ **Evening Timer** (to keep lights on for a set period each night): Flip the switch three times slowly (off-on-off-on-off-on) within 2-3 secs.

#### ■ To Resume Auto Mode:

Switch power off for at least 10 seconds, then back on.

### Will STL360 detect animals?

STL360 may detect large animals. Having animals trigger the sensor can give property a "lived-in" look. However, you can limit animal detection by turning down the sensitivity knob and/or placing the blinders provided on the lower part of the forward lens.

### How do you make adjustments to the sensor?

Use the adjustment tool provided, or a screwdriver with a 1/8" wide blade, to adjust the controls on the front of the sensor. (see page 11-12)

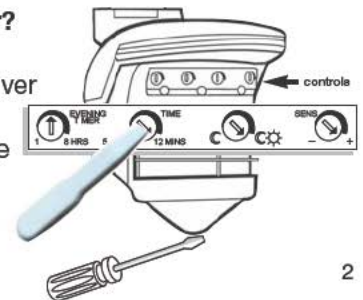

## Choosing a Location

The best location is where the sensor can “see” all paths of movement. The sensor may be wall or soffit mounted.

As distance from the sensor increases, larger movement will be required for detection. For instance, at 10 feet, a half step will be enough, while at 50 feet several steps will be necessary for detection.

### How large an area does STL360 protect?

Two powerful detectors combine to give the STL360 180° x 60' long forward range plus superb 360° downward detection below and to all sides.

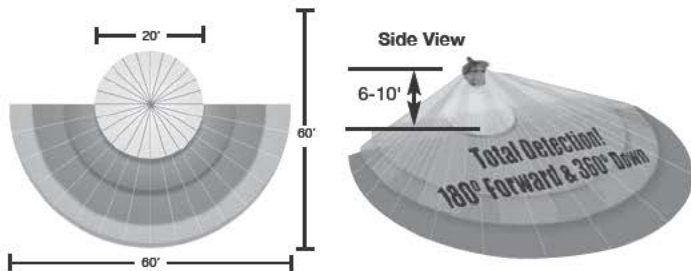

### Mounting Height

Mounting at 6-12' above the ground allows maximum range. If the sensor is mounted above 15' high, the usable range is reduced.



Maximum Range



Reduced Range

### Difficult Locations

Sensor may be triggered by unwanted movement or heat source, such as a swaying tree, road traffic, dryer vent, swimming pool or hot tub.

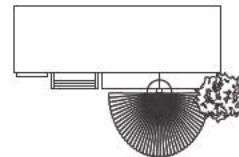

To Improve Performance in Difficult Locations:

- Reduce sensitivity by turning the SENS knob counterclockwise,

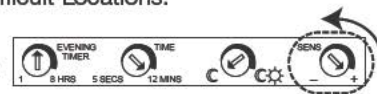

and/or...

- Mask lens in the direction of the unwanted movement or heat source using the lens mask provided or opaque tape



### Mounting Stability

- Mount sensor on stable surface. Do not mount on a tree or pole that will move in the wind.
- Make sure sensor and lights are mounted firmly. If they move when touched, tighten all screws.

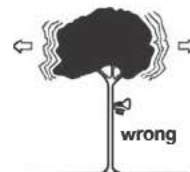

### Light vs. Sensor Position

- Make sure heat from lights is not triggering sensor. Sensor must be located below and as far away as possible from its lights.



**STL360Q1, STL360Q2 & STL360Q3 Kits**  
Mount only on non-combustible surfaces.



# Choosing a Location

## Locations Near Roads

Cars and passing traffic may activate the sensor if it is aimed at the road.

### To Improve Performance in Locations Near Roads:

- Reduce sensitivity by turning the SENS knob counterclockwise.

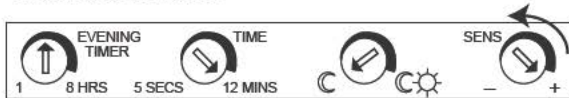

- Mask the lens in the direction of the traffic using the lens mask provided or opaque tape. (Lens mask can be broken along lines to desired size)

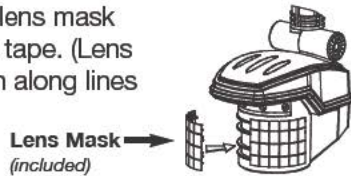

- Make sure that sensor is not aimed at traffic. The sensor should be aimed down so that the maximum range of the sensor ends at least 20' from the road. This will avoid detection of passing trucks and cars, or the air currents they create.

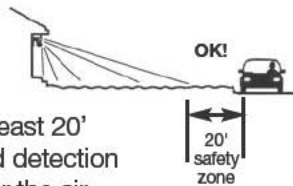

## Mount Level

The sensor should be mounted level from side to side and pointed at the area where you desire coverage. If tilted, part of the detection zone may be high in the air over people's heads.

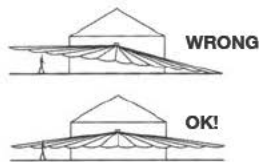

## Locate for Movement Across Pattern

Check that movement is not directly towards sensor. Sensor will see movement ACROSS its pattern more quickly. Check that movement far away and directly towards sensor is not entirely within one zone. To fix, change the sensor location.

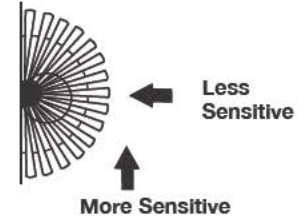

If the sensor is located over a pathway so all movement is directly toward it, range may appear limited. "Micro Adjust" sensor by moving sideways 1/4" or so, which may reposition the zones enough to allow earlier detection.

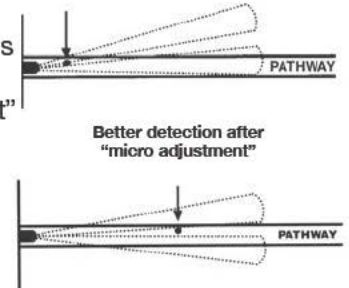

## Choose a Protected Location

Mount sensor in protected area. The more protected the mounting location, the less chance of lights turning on occasionally during rain, snow and windstorms because the sensor is detecting dramatic changes in temperature.

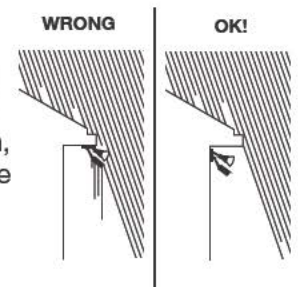

## STL360 Kit Assembly and Wiring



STL360 floodlight kits come pre-wired and assembled on the RAB CU4 EZ plate, allowing for mounting on round, rectangular or octagonal surface or recessed boxes.

### Mounting

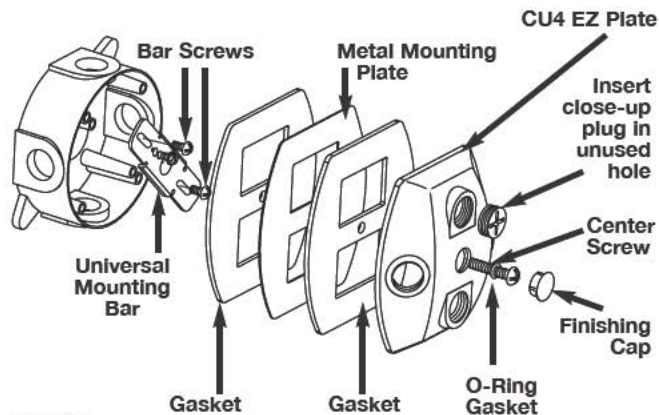

### Wiring

Red pigtail is only used to switch remote or additional fixtures.

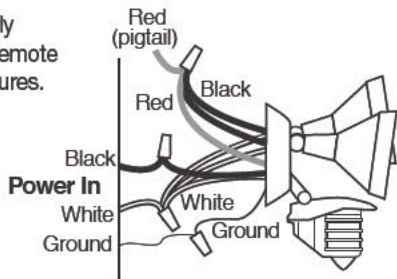

1. Attach the Universal Mounting bar with the bar screws (provided) to the junction box. If you are attaching your STL360 kit to a surface mount weatherproof box, you must use both gaskets, with the metal mounting plate sandwiched between.

2. **Easy Wiring Tip:** Use the "S" shaped Hands Free Hanging Hook to hold the EZ Plate during wiring.

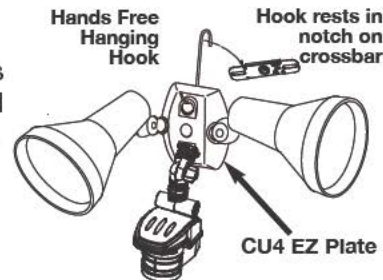

3. Bring power leads and sensor kit leads through holes in all gaskets into junction box.
4. Strip 1/2" of insulation from all leads.
5. Attach ground wire(s) to junction box grounding screw. Connect as shown in wiring diagram on page 7.
6. Twist on wire nuts. Secure with electrical tape.
7. Align gaskets, EZ Plate and metal mounting plate to insure proper seal. Tighten EZ Plate center screw (make sure O-Ring gasket is on the screw) to attach EZ Plate to the box.
8. Insert plastic Finishing Cap in the center of the CU4 EZ Plate for a weatherproof seal.
9. Use silicone sealant around all openings to insure a weatherproof seal.
10. Screw in light bulbs. Turn on power. Conduct walk test to adjust sensor response (see page 15).

## STL360 Assembly and Wiring

■ To install a STL360 Sensor with separately purchased floodlights, start at #1.

■ To install STL360 Pre-wired Floodlight Kits, see page 7.

1. Screw the threaded arms of each floodlight into the RAB CU4 EZ Plate. ( See diagram on page 7)
2. Screw the threaded arm of the sensor into the bottom hole of the EZ Plate. Sensor should be below and as far away from the floodlights as possible.
3. Attach the Universal Mounting bar with the bar screws (provided) to the junction box. If you are attaching your STL360 kit to a surface mount weatherproof box, you must use both gaskets, with the metal mounting plate sandwiched between.

### 4. Easy Wiring Tip:

Use the "S" shaped Hands Free Hanging Hook to hold the EZ Plate during wiring.

5. Bring power leads, light fixture and sensor leads through holes in all gaskets and mounting plates into junction box.
6. Attach ground wire(s) to junction box grounding screw.
7. Position EZ Plate gaskets and metal plate. (see pg #7)
8. Strip 1/2" of insulation from all leads. Connect as shown in wiring diagram.
9. Twist on wire nuts. Secure with electrical tape.
10. Make sure all unused openings in EZ Plate are closed with plugs (provided).

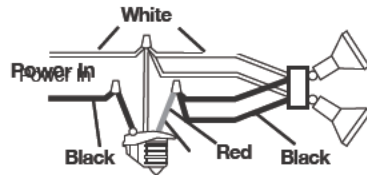

11. Screw in light bulbs. Turn on power.
12. Conduct Walk Test to adjust sensor response (see page 15).

## Multiple Sensors

Multiple sensors may be wired together, but doing this will make problems difficult to troubleshoot. Single sensors that control their own lights will give a more accurate location of movement and trouble-free operation.

## Multiple Fixtures

Multiple fixtures may be wired to a single sensor.

To handle loads greater than 1,000 watts, a qualified electrician should install a relay.

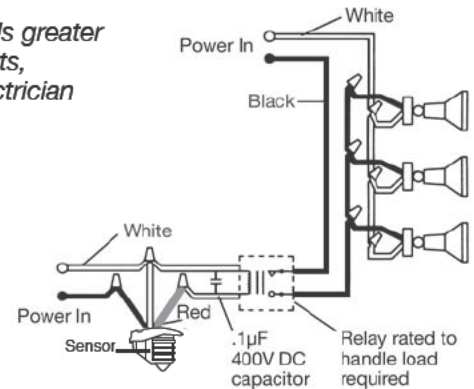

## Power Quality

It is not recommended to install sensors on a circuit that also feeds motor loads such as HVAC equipment, kitchen appliances, or garage door openers. The Stealth circuit is surge and transient protected to IEC specifications. However, if voltage varies significantly from 120 volts, which may occur on circuits with motor loads, the sensor may malfunction.

## Adjusting the Settings

### TIME



Sets the time that lights will remain on after the detection zone is vacated. Adjustable from approximately 5 seconds to 12 minutes. The Factory Setting is 12 minutes.

### PHOTOCELL



For night-only operation, turn the knob completely counterclockwise to (to the MOON symbol). For 24-hour operation turn the knob all the way clockwise to the MOON/SUN symbol. Adjust counterclockwise to have the sensor come on later at dusk, clockwise to have it come on earlier. The Factory Setting is Night-only (MOON). If you set Evening Timer while set to 24 hour operation, Evening Timer will begin immediately after flipping switch.

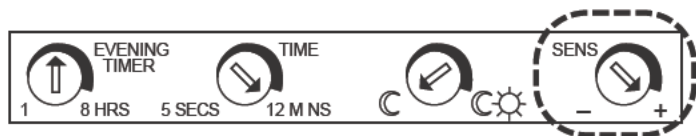

### SENSITIVITY

Increases or decreases the responsiveness and range of the sensor (adjustable from 30% to 100%). The Factory Setting is 100%.



### EVENING TIMER

The STL360 provides an alternative to normal motion-activated lighting. The EVENING TIMER can keep lights on continuously – without motion – for 1 to 8 hours after dusk. This is great for evening activities requiring continuous light. During vacations the EVENING TIMER provides a “lived-in” look by simulating an occupant turning lights on at dusk, and then off at bedtime.

To set the EVENING TIMER, flip the wall switch controlling the sensor three times slowly (off-on-off-on-off-on) within 3 seconds. If you set the EVENING TIMER during daytime, the middle LED should start blinking, indicating that the Evening Timer will start when dusk is detected.

Choose the length of time you want continuous lighting. For example, if you set the EVENING TIMER to “8,” the sensor will keep lights ON continuously for 8 hours after dusk. Once 8 hours have passed, the sensor will revert to motion activated mode. At dawn, the photocell will detect light and prevent lights from turning on during the daytime.

If you do not want to use the EVENING TIMER, do NOT flip the switch 3 times, as described above.

To end use of the EVENING TIMER, switch OFF the power for at least 10 seconds, then ON again. Sensor will be in Automatic Mode. (After completing the warm-up period)

You can affix this label (right), provided, to your indoor light switch plate for easy reference.

#### **RAB STEALTH360**

**To Keep Lights On:**  
Switch off-on-off-on within 2 seconds. Resets to Auto Mode at dawn.

**To Set Evening Timer:**  
To keep lights on for 1-8 hours after dusk, set the Evening Timer knob on the sensor, then flip this switch off-on-off-on-off-on within 3 seconds.

**To Resume Auto Mode:**  
Switch off for 10 seconds, then back on.



## Sensor Modes

### AUTOMATIC MODE

Lights will turn on when there is movement within the detection zone after dusk.



### EVENING TIMER MODE

Keeps lights on for 1-8 hours after dusk. Sensor then reverts to Automatic Mode until dawn. If you set the Evening Timer Mode during daylight, the sensor will be prepared to turn on at dusk and remain on for the number of hours you set. When the sensor is in "Ready for Evening Timer Mode", the middle LED will blink 3 times, pause and repeat. Set the Evening Timer by flipping the switch that operates the sensor 3 times within 3 seconds (off-on-off-on-off-on).



### TEST MODE

To enter Test Mode, turn power off for 10 seconds, then back on. There is a 30 second warm-up period, then the Test Mode starts. During the warm-up, the lights stay on continuously and LEDs are off.

During the Test Period, the sensor will keep lights on for 3 seconds each time it detects movement in its detection zone. The sensor will revert back to Automatic Mode after 2 minutes of Test Mode. However, if you keep "testing" continuously, the sensor will stay in Test Mode. To end Test Mode you must vacate the detection zone for 1 minute or more. Scanning LEDs will appear when test mode ends.

If you require 2 more minutes of Test Mode, turn the power off for at least 10 seconds and back on again. In Test Mode no LEDs are lit.

### MANUAL OVERRIDE MODE

The STL360 has a "protected" Manual Override that requires a double-flip of the light switch so momentary power problems do not interfere with normal sensor operation.

By flipping the switch that operates the sensor twice (off-on-off-on) within 2 seconds you will override the sensor to keep lights on continuously until dawn.

If you set the Manual Override Mode during daylight, the sensor will be prepared to turn on at dusk and remain on until dawn. This is a handy feature if you leave home for the day and you want the lights on to greet you when you return. When the sensor is in "Ready for Manual Override Mode" the middle LED will be on.



### TO RESUME AUTOMATIC MODE

Switch OFF the power for at least 10 seconds, then turn it ON again. Sensor will reset to Automatic Mode after completing the warm-up period and Test Mode.

### DAYTIME (24-HOUR) OPERATION OF MANUAL OVERRIDE

If you set Manual Override while set to 24 hour operation, lights will come on and remain on continuously. **Lights will not turn off at dawn.**



## Walk Testing

STL360's full coverage pattern reduces the need for aiming and adjustment. The purpose of the Walk Test is to check and adjust the coverage pattern. The STL360 has a Test Period which allows the sensor to be walk tested day or night.

To enter Test Mode:

The sensor is in Test Mode when power is first applied. Turn power off for at least 10 seconds and back on.

1. Aim the sensor at the traffic pattern you want to detect. Sensor will detect any movement ACROSS its pattern most effectively.

2. Start outside the pattern and walk across the pattern until the lights go on. As distance from the sensor increases, it will take more movement to be detected.

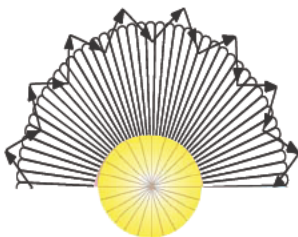

3. Adjust sensor aiming as necessary to improve coverage. Make sure sensor is level.

4. Sensitivity may be decreased with the SENS knob to detect a limited area or if the sensor is being activated by wind, foliage, traffic or animals, or increased to cover a larger area. [See p. 11-12 to adjust sensor settings.] The lens mask can also be used to drastically reduce coverage, or allow undetected movement from some directions.

5. STL360 is factory set for night only operation. For 24 hour operation, turn the photocell control completely toward the SUN/MOON setting. Turn counter clockwise to have the sensor come on later at dusk, clockwise to have it come on earlier.

6. Repeat steps 1-5 until you are satisfied with coverage. Your sensor is now ready for operation.

## Technical Tips: Lights Do Not Turn Off

1. Make sure that the sensor is not in Manual Override Mode. Turn power OFF for 10 seconds, then ON Sensor will be in Test Mode for approximately 2 minutes, then it will switch to Auto Mode with lights off and ready to detect movement.

2. Make sure that the sensor is not in Evening Timer Mode. Turn power OFF for 10 seconds (see #1).

3. Make sure sensor is not aimed at or mounted over something that would move or change temperature such as waving branches, water, air conditioners, windows or heating vents—even on neighboring property. You can test for infrared sources in the area by placing a box or bag over the sensor. Put sensor into test mode. Lights should stay off. Wave your hand inside bag in front of sensor. Lights should go on and then time out. If sensor operates properly when covered, check items #4-8.

Problem: Sensor is triggered by unwanted movement or heat source.

Solution:

- (1) Aim sensor away from movement, or
- (2) Mask lens as in the direction of the source
- (3) Lower sensitivity control setting

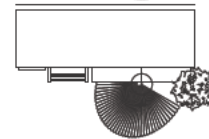
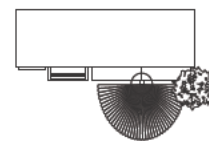

4. Make sure sensor and lights are mounted firmly and do not move even slightly when touched. If they move, tighten all screws.

5. Make sure sensor is not mounted on an unstable object such as a tree or pole that will move in the wind.

Problem: Movement of tree triggers sensor.

Solution: Mount on stable surface.

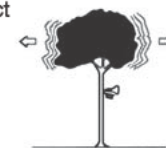

6. Was sensor wired hot? If so, circuitry may have been damaged.

7. Make sure sensor is not aimed within 20 feet of a road.

Problem: Passing cars activate sensor.

Solution: A 20 foot safety zone and lower sensitivity are recommended to avoid activation from passing cars.

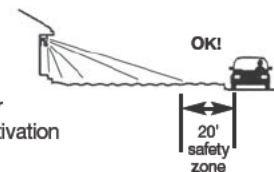

8. Make sure heat from lights is not triggering sensor. Make sure the sensor is below and as far as possible away from sensor.

## Technical Tips: Lights Turn On and Off Inappropriately

1. Make sure the sensor is installed on its own dedicated circuit, free of motor loads such as HVAC equipment, kitchen appliances or garage door openers.
2. It is not recommended to wire sensors in parallel. More than one sensor wired together makes them difficult to troubleshoot. Disconnect multiple sensors and test separately.
3. Keep all people completely out of the detection pattern to make sure the sensor is not detecting them.

4. Make sure sensor is located below and as far as possible from its lights. Heat from the lights may trigger the sensor.

Solution: Move sensor below and away from the lights.

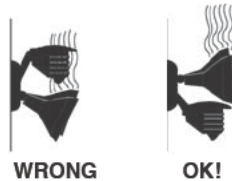

5. Make sure lights are not reflecting back into sensor. Check for white or reflective surfaces close to the sensor.

Solution: Aim sensor away from reflective objects, or move the objects and lower sensitivity.



6. Make sure sensor is not aimed within 20 feet of a road or sidewalk. Passing cars will activate sensor.

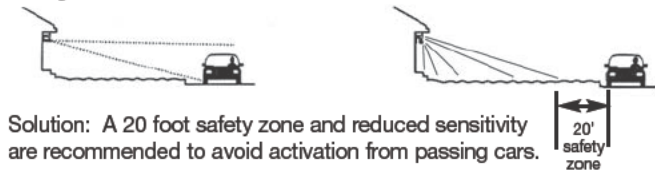

Solution: A 20 foot safety zone and reduced sensitivity are recommended to avoid activation from passing cars.

7. Heavy rain, snow or high winds may activate the sensor occasionally. Reduce sensitivity control slightly until problem stops.
8. Moths can be attracted to the lights and fly close to the sensor causing triggering. Reducing the sensitivity may help.
9. Check Solutions #3, 4, 5, 6, 7, and 8 under "If Lights Do Not Turn Off".

## Technical Tips: Lights Do Not Turn On

1. Check that lamps and fixtures work. Compare wiring to the wiring diagram in this manual. Check that the power is on.
2. If installing during daylight, remember that the sensor will provide 2 minutes of Test Time after power is turned on. After 2 minutes, the sensor will switch to Automatic Mode and will not work during daylight if the photocell control is turned to the night only position (moon symbol).

If you require 2 more minutes of Test Time, turn the power off for at least 10 seconds and back on again.

If you require the sensor to operate both day and night, turn the SUN/MOON control knob clockwise to the sun and moon symbol.



3. Check that lights from another source, such as adjacent porch lights, garden lights or street lights are not in the sensor's view. The sensor's photocell may detect the light and deactivate "daylight".

If you desire the sensor to operate in higher ambient light levels, turn the SUN/MOON control knob counter-clockwise toward the sun symbol.



4. Was sensor wired hot? If so circuitry may have been damaged.

## Technical Tips: Lights Turn Off Too Quickly

1. Check if sensor is being “tricked” by reflected light. If lights controlled by the sensor shine or reflect into the photocell (located behind the lens) the unit will go on briefly, see its own light, and turn off “thinking” that it is daytime:

**Problems:**  
Lights reflect into photocell  
Lights shine directly into photocell

**Solution:**  
Adjust SUN/MOON knob slightly clockwise, to allow operation at higher ambient light levels. Alternatively, move the lights or reflectors or mask the lens in the direction of the lights and/or reflections.

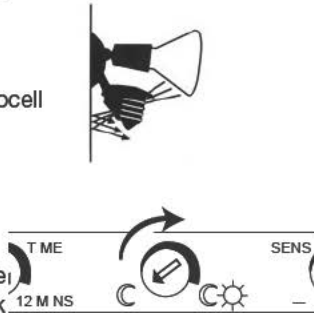

2. Check if “R” lamps, non-reflector “A” lamps or self-ballasted PL lamps are being used in a non-enclosed lampholder. If so, switch to reflector PAR floodlight lamps or Quartz floods so the sensor is not affected by stray light. If using PAR floodlights, consider using lower wattage, energy saving lamps.

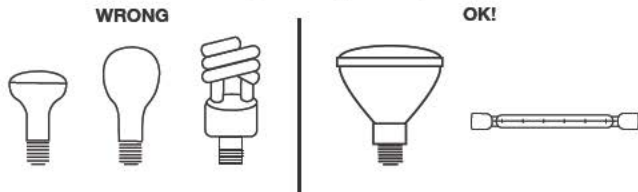

## Technical Tips: Range Appears Limited

1. Check that the sensor is level from side to side and pointed at the area you desire. If unit is tilted, part of the detection zone may be high in the air over people's heads.

**Solution:** Position sensor exactly level from side to side.

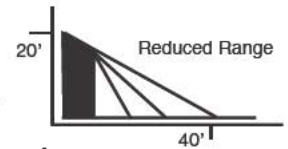
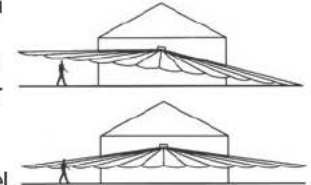

2. Check that the sensor is not mounted too high. If mounted above 20 feet, much of the usable range will be lost.  
**Solution:** Mounting at 6 feet to 10 feet allows maximum range.

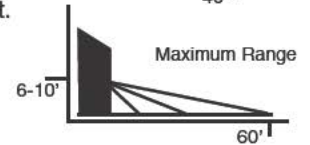

3. Check that movement is not directly towards sensor. Sensor will see movement across its pattern more quickly. To fix, move the sensor.

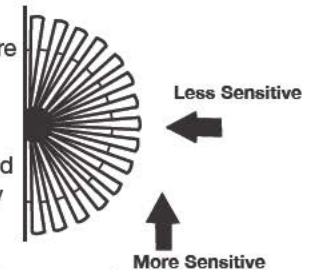

4. Check that movement far away and directly towards sensor is not entirely within one zone.

**Problem:** Sensor will not detect until movement crosses zones

**Solution:**  
“Micro Adjust” sensor by moving sideways 1/4". This may move the zones to allow earlier detection.





## Replacement Lamps

STL360Q1	150 watt double-ended quartz flood
STL360Q2 (2 lamps)	150 watt double-ended quartz flood
STL360Q3	300 watt double-ended quartz flood
STL360H (2 lamps)	150 watt PAR38
STL360HB (2 lamps)	150 watt PAR38

NOTE: All double ended quartz fixtures must be mounted with the lamp horizontal, or parallel to the ground. If the fixture is tilted, the lamp will fail prematurely.

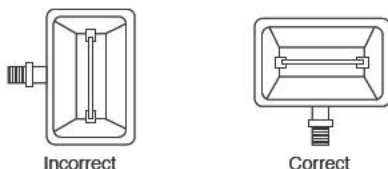

## Limited Warranty

Your STL360 will be replaced or repaired, at our option, if it proves to be defective in workmanship or materials within ten years from the date of original purchase.

For repair replacement, return the product freight prepaid and insured to **RAB Lighting/170 Ludlow Avenue/Northvale, NJ 07647**. The STL360 should be packed carefully. Please include your sales receipt and a description of the problem.

If your unit is out of warranty, or the damage is unrelated to the original manufacture, return your unit directly to us with a check for \$20.00 (made out to RAB Electric). We will repair or replace your unit.

Under no circumstances shall we be liable for any incidental or consequential damages arising out of or in connection with the use or performance of this product or other indirect damages with respect to loss of property or revenue or cost of installation, removal or re-installation. This warranty gives you specific legal rights and you may also have other rights which vary from state to state.

## Contents of Accessory Kit

- 2 Lens Masks
- Indoor Switchplate Label
- 3 Wire Nuts
- Adjustment Tool
- Mylar Lens Mask

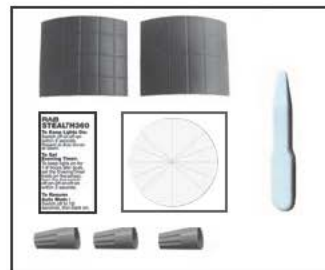

- Crossbar with Green Ground Screw
- Hanging Hook
- 1/2" Close Up Plugs (3)
- Slotted Screws (4)
- Finishing Cap
- O-ring Gasket
- Center Mounting Screw

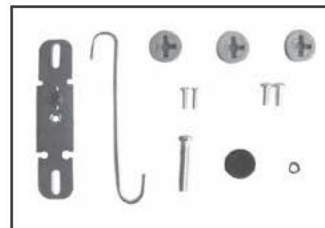

- Foam Gaskets (2)
- Metal Plate



## Easy Installation & Product Help

### Toll Free Phone

Call our friendly experts.  
8AM - 6PM ET Mon. - Fri.  
888 RAB-1000

### Toll Free Fax

Send faxes to RAB  
24/7.  
888 RAB-1232

### Fax on Demand

Faxed information,  
24/7.  
888 RAB-1236

### E-mail

Questions and requests  
answered promptly  
tech@rabweb.com

### www.rabweb.com

Visit our internet site  
for product information

RAB Lighting

170 Ludlow Avenue Northvale, New Jersey 07647 U.S.A.

© RAB Lighting 2004

