

# SORAA® VIVID 2 LED MR16 2700K 12VAC 8-10W



Narrow Flood and Flood



Narrow Spot



reddot design award  
winner 2013



RoHS

Soraa Inc.  
6500 Kaiser Drive,  
Fremont, CA 94555  
855 GO-SORAA  
855 467-6722  
www.soraa.com

<b>OUTPUT</b>	1075-4300 CBCP, 320-400 Lumens
<b>BEAM</b>	10°, 20°, 25°, 36°
<b>COLOR</b>	CCT: 2700K CRI>95, R9>95
<b>APPLICATION</b>	Halogen replacement for unventilated indoor and outdoor applications

## PERFORMANCE

CBCP matches standard halogen lamps  
Single light source  
Single crisp shadow  
Dimmable to 20%  
Power Factor: 0.93  
12V (10.8 min, 13.2 max)

## COLOR

CCT: 2700K  
CRI>95, R9 95  
White point accuracy within 3 SDCM  
Rich saturated color rendering  
Excellent color stability

## OPTIMIZED FORM

ANSI standard MR16 form factor:  
1.96" (50mm) W x 1.86" (47.6mm) H  
Works in all standard fixtures  
Weight: 40g  
Proprietary fanless aluminum design  
provides superior thermal dissipation

## HIGHLY COMPATIBLE

Works with magnetic and electronic  
transformers and dimmers (see complete  
list at [www.soraa.com](http://www.soraa.com))  
UL and CUL listed for use with 12VAC NEC  
Class 1 and Class 2 systems

## SPECIFICATIONS\*

Reference Number	Product Code	Beam	Field	CBCP	Watts	Halogen Equivalent**	Lumens
MR16-40-B01-12-927-10-2	00263	10°	20°	4300	8	40W	320 (40 lm/W)
MR16-50-B01-12-927-20-2	00215	20°	38°	2550	9.8	50W	400 (41 lm/W)
MR16-50-B01-12-927-25-2	00223	25°	42°	2320	9.8	50W	400 (41 lm/W)
MR16-50-B01-12-927-36-2	00275	36°	60°	1075	9.8	50W	400 (41 lm/W)

\*at stable operating conditions in well ventilated fixtures (25°C ambient) \*\*Energy Star Minimum

## LONG LIFE, LOW MAINTENANCE

Life of 35,000 hours  
Three year warranty

## ENERGY EFFICIENT

Saves over 80% of energy compared to  
standard halogen lamps  
Typical payback of one year or less

## INTENDED USE AND APPLICATIONS

LED retrofit lamp to replace 12VAC  
halogen MR16 lamps for use in outdoor  
sealed or unventilated fixtures, indoor  
sealed or unventilated fixtures, or  
applications with glass lenses  
Not for use in Emergency Fixtures or Exit  
Signs  
Operating Temperature: Minimum: -40°C  
(ambient); Typical: 80-110°C (base);  
Maximum: 120°C (base)  
Soraa lamps are designed to safely turn  
down in any thermal environment not  
conductive to minimum airflow or proper  
ventilation

## CERTIFICATIONS

UL, CUL for 12VAC NEC Class 1 and Class  
2 systems, FCC 47 CFR Part 15 and Part 18  
(EMI), RoHS, CE, C-tick

Form Factor | Base | Voltage | CRI | CCT | Beam  
MR16 - 50 - B01 - 12 - 927 - 25

The diagram at left shows how to read the  
different components of the reference number.  
Base type B01 refers to the GU 5.3 base.

12VAC



2700K

CRI  
>95

R9  
>95



DIM



# SORAA VIVID 2 MR16 LED 2700K 12VAC 8-10W

## PHOTOMETRICS

### Narrow Spot - 10°

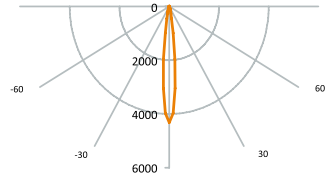
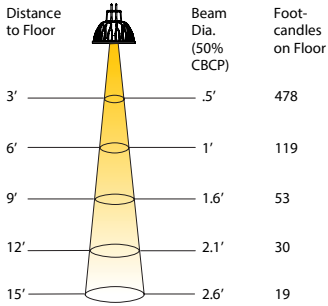

### Narrow Flood - 20°

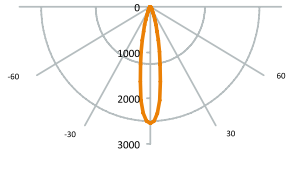
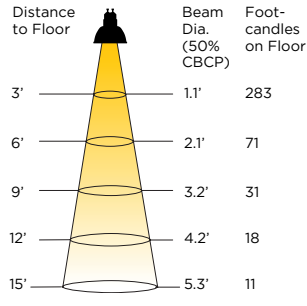

### Narrow Flood -25°

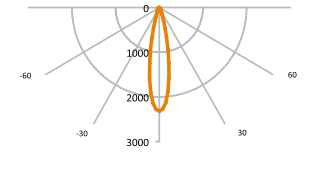
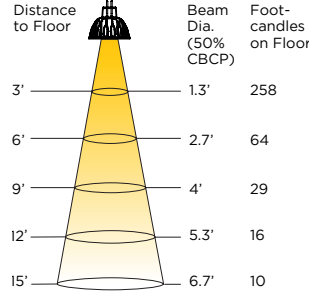

### Flood -36°

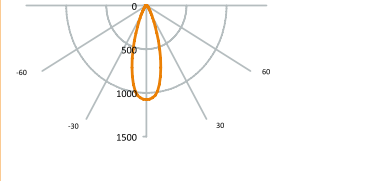
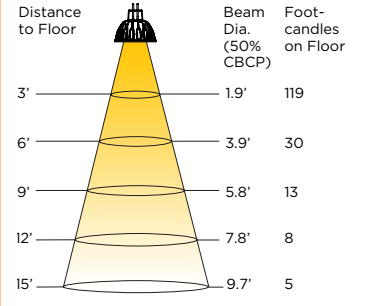

## DIMENSIONS

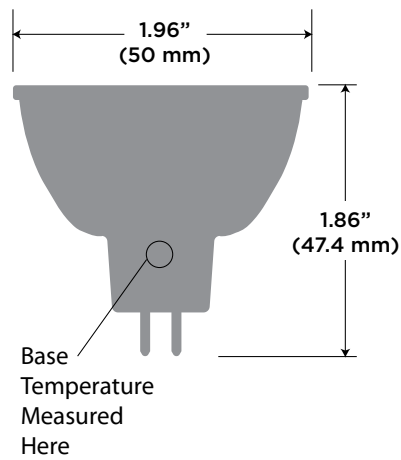

## COLOR RENDERING

CRI- Relative R Values

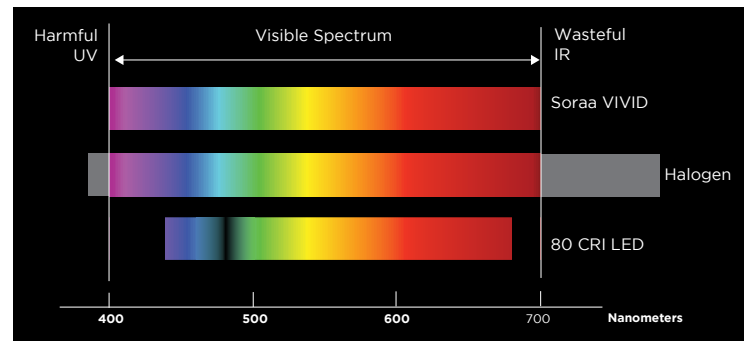
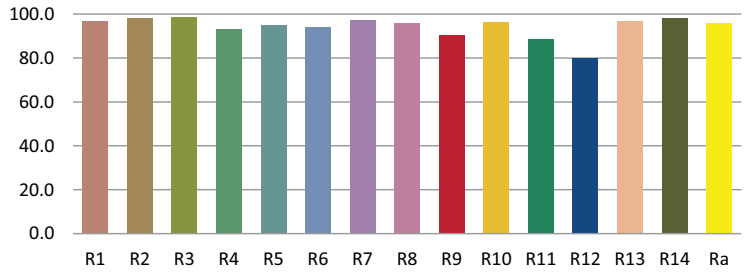

## SAFETY NOTE ON HEAT

Soraa's unique LED technology allows its lamps to operate effectively and efficiently at higher temperatures than other LED lamps, resulting in more light output per diode. Although Soraa's lamps operate at cooler temperatures than halogen lamps, it is recommended that gloves be worn when handling bare lamps that have been energized.

## TRANSFORMER/DIMMER COMPATIBILITY

Dimmable to 20% or lower, depending on dimmer. Complete transformer and dimmer compatibility information available at [www.soraa.com](http://www.soraa.com).

Information and specifications subject to change. Rev H 5.17.13 D-110133

**Soraa Inc.** 6500 Kaiser Drive, Fremont, CA 94555  
855 GO-SORAA / 855 467-6722 [www.soraa.com](http://www.soraa.com)