

## Passive Infrared Wall Switch Occupancy Sensor



PW-100



PW-100-347

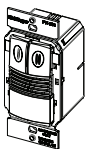

PW-200



PW-200-347

### Specifications

#### Voltages:

PW-100 & PW-200 . . . . . 120/277VAC, 50/60Hz

PW-100-347 & PW-200-347 . . . . . 347VAC, 50/60Hz

#### Load Limits for each relay:

@120VAC . . . . . 0-800W tungsten or ballast, 1/6 HP

@277VAC . . . . . 0-1200W ballast

@347VAC . . . . . 0-1500W ballast

#### Load Type Compatibility:

Incandescent, fluorescent, magnetic or electronic ballast

Horsepower Rating (each relay) . . . . . 1/6 HP @120VAC

Time Delay Adjustment . . . . . 5 to 30 minutes

Walk-Through Mode . . . 3 minutes if no activity after 30 sec.

Test Mode . . . . . 5 sec. for 10 min. with DIP switch setting

PIR Adjustment . . . . . High or Low (DIP switch)

Light Level Adjustment . . . . . 8fc to 180+fc

Alerts . . . . . Selectable Audible & Visual

US Patents: 5640113, 6617560

**WattStopper®**

Santa Clara, CA 95050

800.879.8585

Installation Instructions

## UNIT DESCRIPTION AND OPERATION

The PW Passive Infrared Wall Switch sensors use advanced passive infrared (PIR) technology.

The PW sensor can turn a load on, and hold it on as long as the sensor detects occupancy. After no movement is detected for the selected time delay, the lights switch off. A “walk-through” mode can turn lights off after only 3 minutes, if no activity is detected after 30 seconds following an occupancy detection.

The PW-100 has one relay and one **ON/OFF** button. The PW-200 contains two relays and two **ON/OFF** buttons to allow control of one or two loads independently. Pressing a button toggles the state of the corresponding relay.

PW sensors contain a light level sensor. If adequate daylight is present, the sensor holds the load **OFF** until light levels drop, even if the area is occupied. In the PW-200, light level only affects the load on Relay 2. Users can overrule the hold **OFF** function by pressing the **ON/OFF** button. See Light Level Adjustment.

### Turning Load(s) ON (ON Mode)

The relays are programmed independently for either Auto **ON** or Manual **ON**. In either mode, the load can be turned **ON** or **OFF** using the **ON/OFF** button.

<b>Manual ON</b> DIP 8 <b>ON</b> for Relay 1  DIP 9** <b>ON</b> for Relay 2	With an <b>ON</b> Mode DIP switch in the <b>ON</b> position, the occupant must press the <b>ON/OFF</b> button to turn <b>ON</b> the load. The sensor keeps the load <b>ON</b> until no motion is detected for the selected time delay. There is a 30 second re-trigger delay. If occupancy is detected during the delay, the sensor turns the load back <b>ON</b> . After the re-trigger delay elapses the <b>ON/OFF</b> button must be pressed to turn <b>ON</b> the load.
<b>Auto ON</b> DIP 8 <b>OFF</b> for Relay 1  DIP 9** <b>OFF</b> for Relay 2	With an <b>ON</b> Mode DIP switch in the <b>OFF</b> position, the load turns <b>ON</b> and <b>OFF</b> automatically based on occupancy. If the load is turned <b>OFF</b> manually, Presentation Mode operation applies. This prevents the load from turning <b>ON</b> automatically after it was deliberately turned <b>OFF</b> . Pressing the button to turn lights <b>ON</b> returns the sensor to Auto <b>ON</b> mode.

\*\* PW-100: Switch 9 is not used. PW-200: Switch 9 default is **ON** to comply with CA Energy Commission Title 24 bi-level switching requirements.

Model #	Relay	Default ON Mode	DIP switch #	Setting
PW-100	1	Manual <b>ON</b>	8	<b>ON</b>
PW-100-347	1	Manual <b>ON</b>	8	<b>ON</b>
PW-200	1	Auto <b>ON</b>	8	<b>OFF</b>
	2	Manual <b>ON</b>	9	<b>ON</b>
PW-200-347	1	Auto <b>ON</b>	8	<b>OFF</b>
	2	Manual <b>ON</b>	9	<b>ON</b>

Shading indicates default operation and switch setting.

**Presentation Mode** is a feature of the Auto **ON** mode. When both relays are manually turned **OFF** the PW holds the lights **OFF** until no motion has been detected for the duration of the Time Delay. With subsequent occupancy, the PW turns the load **ON**. If both relays are **ON** and one relay is manually turned **OFF** this relay remains **OFF** until both the Time Delay and retrigger delay expires for the relay that is **ON**, after that time the **ON** Mode control settings again apply.

## Time Delays

The PW sensor holds the load **ON** until no motion is detected for the selected time delay. Select the time delay using DIP switch settings. In the PW-200, both relays use the same delay.

<b>Test/20 min</b> (DIP 1, 2, 3, OFF)	A Test Mode with a short time delay of 5 seconds is set when DIP switches 1, 2, & 3 are <b>OFF</b> . It cancels automatically after ten minutes, or when you set a fixed time delay. When the Test Mode times out, the sensor assumes a 20 minute time delay. To restart Test Mode, change the time delay setting to any fixed amount and then return it to the Test setting.
<b>Fixed Time Delay</b> (DIP 1 ON, 2 & 3 OFF)	Time delays are 5, 10, 15, <b>20</b> (default), 25, or 30 minutes.

## Walk-Through

The Walk-Through mode shortens the time delay to reduce the amount of time the load is **ON** after a brief moment of occupancy, such as returning to an office to pick up a forgotten item then immediately exiting.

<b>Walk-Through Mode</b> (DIP #4 ON)	The PW sensor turns the load <b>OFF</b> three minutes after the area is initially occupied, if no motion is detected after the first 30 seconds. If motion continues beyond the first 30 seconds, the set time delay applies.
<b>No Walk-Through</b> (DIP #4 OFF)	Walk-Through mode disabled.

## PIR Sensitivity Adjustment

The PW sensor constantly monitors the controlled environment and automatically adjusts the PIR to avoid common ambient conditions that can cause false detections, while providing maximum coverage.

<b>High</b> (DIP #5 OFF)	Default setting. Suitable for most applications.
<b>Low, 50%</b> (DIP #5 ON)	Reduces sensitivity by approximately 50%. Useful in cases where the PIR is detecting movement outside of the desired area (also consider masking the lens) and where heat sources cause unnecessary activation.

Visit our website for FAQs: [www.wattstopper.com](http://www.wattstopper.com)

## Alerts

The PW can provide audible and/or visible alerts as a warning before the load turns **OFF**.

<b>Visible Alert</b> (DIP #6 ON)	When only one minute is left in the time delay, the load connected to the relay turns <b>OFF</b> for one second. This provides a one minute warning before the load(s) are turned <b>OFF</b> by the sensor.
<b>No Visible Alerts</b> (DIP #6 OFF)	No visible warnings provided.
<b>Audible Alerts</b> (DIP #7 ON)	Unit will beep at one minute*, at 30 seconds and at 10 seconds before turning <b>OFF</b> load. When Walk-Through is active, the unit beeps three times at 10 seconds before the load goes <b>OFF</b> . *If Visible Alert is also <b>ON</b> , the one-minute time-out warning beep is replaced by the visible alert.
<b>No Audible Alerts</b> (DIP #7 OFF)	No audible warnings provided.

## COVERAGE PATTERNS

Coverage testing has been performed according to the NEMA WD 7 guideline. For best performance, use in spaces not larger than 15' x 12'.

### PIR Sensor

The sensor has a two-tiered, multi-cell viewing Fresnel lens with 180 degree field of view. The red LED on the sensor flashes when the PIR detects motion.

### Masking the lens

Opaque adhesive tape is supplied so that sections of the PIR sensor's view can be masked. This allows you to eliminate coverage in unwanted areas. Since masking removes bands of coverage, remember to take this into account when troubleshooting coverage problems.

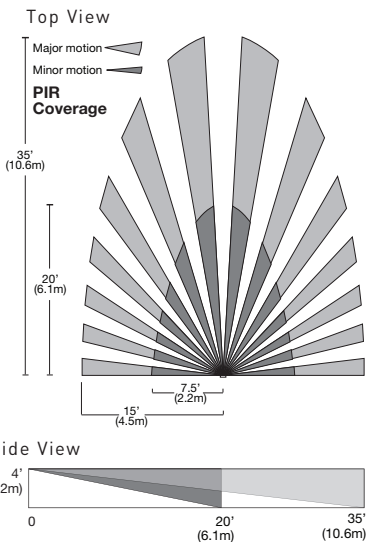

Call 800.879.8585 for Technical Support

## INSTALLATION



### WARNING



**TURN THE POWER OFF AT THE CIRCUIT BREAKER BEFORE INSTALLING THE SENSOR OR WORKING ON THE LOAD.**

1. Make sure that the power has been turned **OFF** at the circuit breaker.
2. Connect wires to the PW flying leads as shown in the wiring diagram that is appropriate to the PW model and electrical supply. **The 2 ground wires (green and green/yellow) must be fastened to ground for the sensor to work properly.**
3. Attach the sensor to the wall box by inserting screws into the two wide holes on the top and bottom of the attached metal bracket. Match them up with the holes in the wall box and tighten.
4. Turn the circuit breaker **ON**. Wait one minute, then push the Auto **ON/OFF** switch for each load and the lights will turn **ON**. There is a delay due to initial power-up of the sensor that only occurs during installation.
5. Test and adjust the sensor if necessary.
6. Install industry standard decorator wall switch cover plate (not included).

#12 - #14 AWG



Cu Wire Only

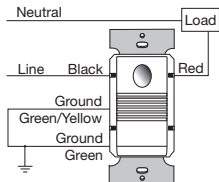

**PW-100 and PW-100-347 Wiring**

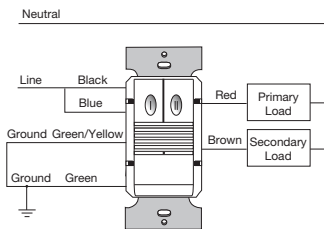

**PW-200 and PW-200-347  
Bi-Level Wiring**

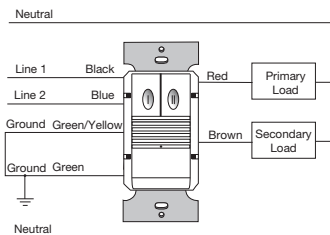

**PW-200 and PW-200-347  
Dual Circuit Wiring**

# DIP SWITCH SETTINGS

Time Delay	1	2	3
Test/20 min	↓	↓	↓
5 minutes	↓	↓	↑
10 minutes	↓	↑	↓
15 minutes	↓	↑	↑
20 minutes	↑	↓	↓
25 minutes	↑	↓	↑
30 minutes	↑	↑	↓
Service	↑	↑	↑

Walk-Through	4
Enabled	↑
Disabled	↓

Service bypasses occupancy & light level functions. Control the load manually using **ON/OFF** button.

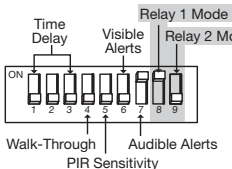

PIR Sensitivity	5
Low, 50%	↑
High	↓

Visible Alert	6
Enabled	↑
Disabled	↓

↑=ON ↓=OFF

Audible Alert	7
Enabled	↑
Disabled	↓

Relay 1 Mode	8
Manual On	↑
Auto On	↓

PW-200 ONLY

Relay 2 Mode	9
Manual On	↑
Auto On	↓

Factory Settings:

- ◀ All models
- ▲ PW-100 series
- ▲ PW-200 series

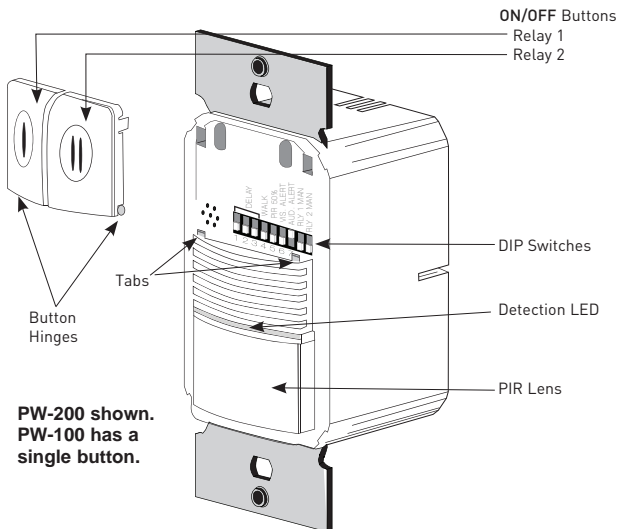

PW-200 shown.  
PW-100 has a single button.

Call 800.879.8585 for Technical Support

## ADJUSTMENTS

### Sensor Adjustment

Remove the wall plate. Remove the button cap by firmly squeezing together the top sides of the button assembly. Gently pull it away from the unit.

When the adjustments are completed, replace the button cap by inserting its hinges into the tabs on the main unit and then squeeze the top of the button while pressing it into the unit. Reinstall the cover plate.

### Light Level Adjustment

The light level can be set with loads **ON** or **OFF**. To enable light level control and set the threshold: 1) Make sure the room is lit appropriately. 2) Put the sensor into TEST mode (see Time Delay switches). You have 5 minutes to complete the procedure. 3) Press and hold the ON/OFF button (Relay 1 button on the PW-200) for 3 seconds, until you hear a beep. 4) Step away from the sensor. After 25 seconds a beep sounds, indicating that the threshold level is set. This threshold is retained, even if power is lost, until it is re-set or disabled. In the PW-200, light level control only affects Relay 2.

To disable light level control, press and hold the Relay 1 button for **7 seconds**, until a double beep tone sounds.

### Reset to Default

Use the DIP Switch Settings tables on the previous page to return features to factory settings. To reset the PW press and hold the Relay 1 button for **10 seconds**, until a triple beep sounds. This resets the sensor and disables light level control (the brightest ambient light will not hold the light **OFF**).

## TROUBLESHOOTING

### Lights do not turn ON with motion (LED does flash)

1. Press and release each button to make sure that the correct lights come **ON** for each relay. **If the lights do NOT turn ON**, check wire connections, especially the Load connection. **If the lights turn ON**, verify that the correct On Mode is selected in DIP switches 8 and 9.
2. Check to see if light level control is enabled: cover the sensor lens with your hand. If the lights come **ON**, adjust the light level setting.
3. If lights still do not turn **ON**, call 800.879.8585 for technical support.

### Lights do not turn ON with motion (LED does not flash)

1. Press and release each button to make sure that the correct lights come **ON** for each relay. **If the lights turn ON**, verify that Sensitivity is on High.
2. Check the wire connections, in particular, the Line connection. Verify that connections are tightly secured.
3. If lights still do not turn **ON**, call 800.879.8585 for technical support.

## Lights do not turn OFF

1. There can be up to a 30 minute time delay after the last motion is detected. To verify proper operation, set DIP switch 1 to **ON**, then reset switches 1, 2, and 3 to **OFF** to start Test Mode. Move out of view of the sensor. The lights should turn **OFF** in approximately 5 seconds.
2. Verify that the sensor is mounted at least six feet (2 meters) away from any heating/ventilating/air conditioning device that may cause false detection. Verify that there is no significant heat source (e.g., high wattage light bulb) mounted near the sensor.
3. If the lights still do not turn **OFF**, call 800.879.8585 for technical support.

## Sensing motion outside desired areas

1. Select PIR Sensitivity – Low (DIP switch 5 = **ON**) if necessary.
2. Mask the PIR sensor's lens to eliminate unwanted coverage area.

## Red LED is lit all the time and the sensor features don't work.

1. Check DIP switches 1,2,3. If they are all **ON** the unit is in Service Mode. Set the DIP switches to a valid Time Delay setting.
2. If re-setting the Time Delay switches does not clear the LED call technical support.

## COVER PLATES

WattStopper PW series wall switches fit behind industry standard decorator-style switch cover plates. Cover plates are not included.

Units come in the following colors, which are indicated by the final suffix of the catalog number (shown here in parentheses):

White (-W), Light Almond (-LA), Ivory (-I), Grey (-G), Black (-B).

## Warranty Information

WattStopper warrants its products to be free of defects in materials and workmanship for a period of five years. There are no obligations or liabilities on the part of WattStopper for consequential damages arising out of or in connection with the use or performance of this product or other indirect damages with respect to loss of property, revenue, or profit, or cost of removal, installation or reinstallation.

# WattStopper®

2800 De La Cruz Boulevard, Santa Clara, CA 95050  
Technical Support: 800.879.8585 • [www.wattstopper.com](http://www.wattstopper.com)

07124r6 8/2012

Please  
Recycle

